

# **PAC MANAGER USER'S GUIDE LEGACY EDITION**

**SNAP PAC R-Series Controllers**

**SNAP PAC S-Series Controllers**

**SoftPAC Controllers**

**SNAP PAC EB Brains**

**SNAP PAC SB Brains**

**SNAP Simple I/O**

**SNAP Ethernet I/O**

**SNAP Ultimate I/O**

**E1 Brain Boards**

**E2 Brain Boards**



# **PAC MANAGER™ USER'S GUIDE LEGACY EDITION**

SNAP PAC R-Series Controllers  
SNAP PAC S-Series Controllers  
SoftPAC Controllers  
SNAP PAC EB and SB Brains  
SNAP Simple I/O™  
SNAP Ethernet I/O™  
SNAP Ultimate I/O™  
E1 Brain Boards  
E2 Brain Boards

Form 1714-210824–August 2021

**OPTO 22**  
Your Edge in Automation.™

43044 Business Park Drive • Temecula • CA 92590-3614  
Phone: 800-321-OPTO (6786) or 951-695-3000  
Fax: 800-832-OPTO (6786) or 951-695-2712  
[www.opto22.com](http://www.opto22.com)

Product Support Services  
800-TEK-OPTO (835-6786) or 951-695-3080  
Fax: 951-695-3017  
Email: [support@opto22.com](mailto:support@opto22.com)  
Web: [support.opto22.com](http://support.opto22.com)

PAC Manager User's Guide, Legacy Edition

Form 1714-210824—August 2021

Copyright © 2003–2021 Opto 22.

All rights reserved.

Printed in the United States of America.

The information in this manual has been checked carefully and is believed to be accurate; however, Opto 22 assumes no responsibility for possible inaccuracies or omissions. Specifications are subject to change without notice.

Opto 22 warrants all of its products to be free from defects in material or workmanship for 30 months from the manufacturing date code. This warranty is limited to the original cost of the unit only and does not cover installation, labor, or any other contingent costs. Opto 22 I/O modules and solid-state relays with date codes of 1/96 or newer are guaranteed for life. This lifetime warranty excludes reed relay modules, *groov* and SNAP serial communication modules, SNAP PID modules, and modules that contain mechanical contacts or switches. Opto 22 does not warrant any product, components, or parts not manufactured by Opto 22; for these items, the warranty from the original manufacturer applies. Refer to Opto 22 form 1042 for complete warranty information.

---

Wired+Wireless controllers and brains are licensed under one or more of the following patents: U.S. Patent No(s). 5282222, RE37802, 6963617; Canadian Patent No. 2064975; European Patent No. 1142245; French Patent No. 1142245; British Patent No. 1142245; Japanese Patent No. 2002535925A; German Patent No. 60011224.

Opto 22 FactoryFloor, *groov*, *groov* EPIC, *groov* RIO, mobile made simple, The Edge of Automation, Optomux, and Pamux are registered trademarks of Opto 22. Generation 4, *groov* Server, ioControl, ioDisplay, ioManager, ioProject, ioUtilities, *mistic*, Nvio, Nvio.net Web Portal, OptoConnect, OptoControl, OptoDataLink, OptoDisplay, OptoEMU, OptoEMU Sensor, OptoEMU Server, OptoOPCServer, OptoScript, OptoServer, OptoTerminal, OptoUtilities, PAC Control, PAC Display, PAC Manager, PAC Project, PAC Project Basic, PAC Project Professional, SNAP Ethernet I/O, SNAP I/O, SNAP OEM I/O, SNAP PAC System, SNAP Simple I/O, SNAP Ultimate I/O, and Wired+Wireless are trademarks of Opto 22.

ActiveX, JScript, Microsoft, MS-DOS, VBScript, Visual Basic, Visual C++, Windows, and Windows Vista are either registered trademarks or trademarks of Microsoft Corporation in the United States and other countries. Linux is a registered trademark of Linus Torvalds. ARCNET is a registered trademark of Datapoint Corporation. Modbus is a registered trademark of Schneider Electric, licensed to the Modbus Organization, Inc. Wiegand is a registered trademark of Sensor Engineering Corporation. Allen-Bradley, CompactLogix, ControlLogix, MicroLogix, SLC, and RSLogix are either registered trademarks or trademarks of Rockwell Automation. CIP and EtherNet/IP are trademarks of ODVA. Raspberry Pi is a trademark of the Raspberry Pi Foundation. The registered trademark Ignition by Inductive Automation® is owned by Inductive Automation and is registered in the United States and may be pending or registered in other countries. CODESYS® is a registered trademark of 3S-Smart Software Solutions GmbH.

*groov* includes software developed by the OpenSSL Project for use in the OpenSSL Toolkit. (<http://www.openssl.org>)

All other brand or product names are trademarks or registered trademarks of their respective companies or organizations.

Opto 22

Your Edge in Automation.

# Table of Contents

<b>Chapter 1: Introduction</b> .....	<b>1</b>
About this Guide .....	1
Products Covered .....	1
Contents .....	2
Installing OptoOPCServer .....	2
Information Key .....	3
Related Documentation .....	3
For Developers: SNAP PAC REST API .....	4
Product Support .....	4
Opto 22 Feature Comparison Chart .....	5
SNAP PAC Processors and Features .....	9
<b>Chapter 2: Configuring Devices</b> .....	<b>13</b>
Introduction .....	13
When to Use PAC Manager and PAC Control .....	13
Choosing a Configuration Tool for SNAP I/O .....	14
Assigning an IP Address .....	15
About IP Addresses .....	15
Assigning IP Addresses to SNAP PAC, UIO, EIO, and SIO .....	15
What's Next? .....	20
Assigning IP Addresses to E1 and E2 I/O Units .....	21
Assigning IP Addresses to Multiple Devices .....	27
Assigning an IP Address to Ethernet 2 (SNAP PAC Controller Only) .....	30
Configuring Wireless LAN Communication (Wired+Wireless Models Only) .....	35
Connecting with a SNAP PAC SB Brain .....	39
Creating an I/O Unit Configuration File .....	39
Creating a New Configuration File .....	40
Copying an I/O Unit Configuration .....	41
Creating a Configuration File from Another Strategy .....	44
Adding an I/O Unit .....	44
Configuring I/O Modules and Points .....	48
Configuring SNAP Digital Points .....	49
Configuring Analog Points .....	54
Configuring RS-232 and RS-485/422 Serial Communication Modules .....	60
Configuring Wiegand Modules .....	65

Configuring PID Modules .....	67
Configuring Profibus Modules .....	68
Configuring SSI (Serial Synchronous Interface) Modules .....	69
Configuring CAN Modules .....	71
Configuring HART Modules .....	75
Moving a Configured I/O Point .....	77
Copying and Pasting I/O Units .....	77
Configuring PID Loops .....	78
What is a PID? .....	78
Algorithm Choices .....	79
Steps for Configuring PIDs .....	80
Sending Configuration Data to the I/O Unit .....	83
Using PAC Manager to Clear Flash Memory .....	85
Using I/O Point Features .....	85
States (Digital Points) .....	87
Latches (Digital Points) .....	87
Counters (Digital Points) .....	87
Quadrature Counters (Digital Inputs) .....	88
Watchdog (Digital and Analog Points) .....	88
Scaling (Analog Points) .....	88
Minimum and Maximum Values (Analog Points) .....	89
Offset and Gain (Analog Points) .....	89
Clamping (Analog Points) .....	90
Average Filter Weight (Analog Points) .....	90
<b>Chapter 3: Configuring Optional Functions .....</b>	<b>93</b>
Introduction .....	93
Setting Up Network Security (Wired Network) .....	94
Limiting Access to Specific Computers .....	94
Limiting Access to Specific Protocols .....	94
Configuring the PAC as an HTTP/HTTPS Server .....	95
Requiring a Password for FTP .....	96
Protecting a PAC Control Strategy from Interference .....	97
Configuring Ethernet Security on an I/O Unit .....	98
Configuring Ethernet Security on a Standalone Controller .....	101
Logging Data from Memory Map Addresses .....	103
Configuring Data Logging .....	103
Reading the Data Log .....	105
Clearing All Data from the Log .....	106
Configuring Event Messages .....	108
Using Plugins .....	111
Examples .....	112
Configuring SNMP .....	112
SNMP Traps .....	113
SNMP Access Privileges .....	113
Configuring the SNMP Agent .....	113
Configuring DNS Servers .....	115
Configuring Email .....	116

Setting Up Initial Values in the Scratch Pad Area .....	118
Scratch Pad Bits .....	119
Scratch Pad Integers, Floats, or Strings .....	120
Configuring Streaming .....	120
Mirroring I/O Point Data .....	123
Copying Memory Map Data .....	125
Copying Binary or Memory Map Data on the Same I/O Unit .....	125
Copying Binary or Memory Map Data to a Different I/O Unit .....	127
Configuring Modbus Options .....	128
Changing Modbus Float Format .....	128
Determining Modbus Unit ID and Register Address .....	130
Setting Up System Date and Time .....	132
Configuring Direct Communication to Serial Devices .....	134
Configuring Serial Ports on an On-the-Rack Controller .....	134
Configuring Serial Ports on a Standalone Controller .....	136
Configuring PPP .....	139
Configuring PPP on the I/O Unit .....	140
<b>Chapter 4: Setting Up Events and Reactions .....</b>	<b>145</b>
Introduction .....	145
Event/Reaction Concepts .....	145
The Scratch Pad .....	145
Using Scratch Pad Bits for Events and Alarms .....	146
Using Event/Reactions .....	147
Types of Events, Alarms, and Reactions .....	147
Configuring Digital Events and Reactions .....	150
Digital Point and Scratch Pad Masks .....	151
How Digital Events Trigger Reactions .....	152
Configuring Alarms and Reactions .....	156
How Alarms Trigger Reactions .....	156
Configuring Serial or Wiegand Events and Reactions .....	159
Configuring Event Messages .....	161
<b>Chapter 5: Reading and Writing to Specific Devices .....</b>	<b>165</b>
Introduction .....	165
Reading Basic Device Information .....	165
Interpreting Status Data .....	167
Changing Status Data .....	170
Referencing I/O Points .....	173
SNAP PAC Racks .....	174
SNAP B-Series Racks .....	175
SNAP Digital-Only Racks .....	175
Serial Modules .....	176
E1 and E2 Brain Boards .....	176
Configuring I/O Modules, Points, and Features .....	178
Point Types Requiring Configuration .....	178
Point Features Requiring Configuration .....	179

Configuring Analog and Digital Points and Features .....	179
Point Type Configuration Tables .....	181
Configuring, Viewing, or Changing PID Loops .....	190
Reading and Writing to Points .....	192
Reading and Writing to Digital Points .....	193
Reading and Writing to Analog Points .....	195
Reading Analog and Digital Banks .....	200
Reading and Writing to SNAP High-Density Digital Points .....	203
Reading System Date and Time .....	206
Reading and Writing to the Scratch Pad Area .....	206
Data Logging .....	209
Reading or Changing PID Loops .....	209
Reading or Changing PID Module Settings .....	211
Reading or Changing Events and Event Messages .....	211
Reading or Changing Communications and Other Data .....	212
Writing Commands to the Device .....	212
Using OptoMMP Device Commands .....	212
Using microSD Commands .....	215
Using Other microSD Card Commands .....	217
Clearing Configurations and Data Samples .....	217
Formatting and Interpreting Data .....	218
Mask Data .....	218
Unsigned 32-bit Integer Data .....	219
Digital Channel Data (4-Channel Modules) .....	220
IEEE Float Data .....	221
Analog Bank Data .....	222
<b>Chapter 6: Maintaining Devices .....</b>	<b>223</b>
Introduction .....	223
Changing IP Addresses .....	223
Controllers, Brain Boards, and Brains with Firmware R5.0 or Higher .....	223
Installing New Firmware .....	225
Firmware Loading's Effect on Data in the Device .....	225
Loading Controller and Brain Firmware (Except SB Brains) .....	226
Loading SB Brain Firmware .....	229
Loading Serial Module Firmware .....	232
Loading I/O Coprocessor Firmware .....	233
Replacing Damaged Firmware .....	236
Installing CA Root Certificates .....	238
Maintaining Files .....	239
Tools for Managing Files .....	239
Moving Files to the SNAP Controller or I/O Unit .....	241
Moving Files from the SNAP Controller or I/O Unit .....	243
Reading Filenames .....	243
Deleting a File from a SNAP Controller or I/O Unit .....	244
Using Flash Memory with the File System .....	244



<b>Chapter 7: Troubleshooting</b> .....	<b>247</b>
Introduction .....	247
PAC Manager Error Messages .....	247
Trouble Connecting to the I/O Unit or Controller .....	247
Using PAC Manager to Troubleshoot Problems .....	248
Getting Device and Firmware Information—Individual Device .....	248
Getting Device and Firmware Information—Multiple Devices .....	250
TCP Settings .....	251
Checking Ethernet Errors .....	253
Troubleshooting Serial Communication .....	253
Troubleshooting Wireless LAN Communication .....	255
<b>Appendix A: Menus</b> .....	<b>257</b>
File Menu .....	257
Edit Menu .....	257
Tools Menu .....	258
View Menu .....	258
Help Menu .....	259
<b>Appendix B: Dialog Boxes</b> .....	<b>261</b>
Add/Edit Analog Point .....	261
Add/Edit Digital Point .....	262
Add/Edit Event Message .....	262
Add/Edit I/O Unit .....	263
Add/Edit IP Address .....	263
Add/Edit Memory Map Values .....	264
Add/Edit PID Loops .....	264
Add/Modify New Device .....	265
Assign IP Address .....	266
Assign Secondary IP Address .....	267
Configure E-Mail .....	268
Configure Event Messages .....	268
Configure I/O Points .....	272
Configure I/O Points (G4EB2) .....	272
Configure I/O Units .....	273
Configure Memory Map Values .....	274
Configure PID Loops .....	274
Configure PID Modules .....	275
Configure PPP .....	276
Configure Profibus Modules .....	277
Configure Serial Modules .....	278
Configure SNMP Agent .....	279
Configure Streaming .....	280
Configure Wiegand Modules .....	280
Find Opto 22 MMP Devices .....	282
Inspect Opto 22 Device .....	282

I/O Unit Import/Copy .....	283
I/O Unit Maintenance .....	284
Move Point To .....	284
Scale Analog Readings .....	284
Send Configuration To I/O Unit .....	285
Sending Configuration Information .....	285
<b>Index .....</b>	<b>287</b>

# 1: Introduction

## ABOUT THIS GUIDE

Welcome to PAC Manager, the configuration and inspection tool for working with SNAP PAC, SNAP Simple, SNAP Ethernet, and SNAP Ultimate I/O units, SNAP PAC controllers, and E1 and E2 brain boards.

### Products Covered

This guide shows you how to configure and work with the following Opto 22 devices using the software tool PAC Manager. The guide covers both standard wired models and Wired+Wireless™ models.

- SNAP PAC S-series controllers
- SNAP PAC R-series controllers
- SoftPAC controllers
- SNAP PAC EB brains
- SNAP PAC SB brains
- SNAP Ultimate I/O
- SNAP Ethernet I/O
- SNAP Simple I/O
- E1 and E2 units

#### NOTES:

- *If you are using groov EPIC or groov RIO, do not use PAC Manager. Instead, use groov Manage or PAC Control. For details, see the following:*
  - [groov EPIC User's Guide \(form 2267\)](#)
  - [groov RIO User's Guide \(form 2324\)](#)
  - [PAC Control User's Guide \(form 1700\)](#)
- *Allen-Bradley: If you are using SNAP PAC EB brains or SNAP PAC controllers with Allen-Bradley Logix PLC systems, do not use PAC Manager. Instead, use the EtherNet/IP Configurator. For details, see the [EtherNet/IP for SNAP PAC Protocol Guide \(form 1770\)](#). Both the software and the guide are available on our website, [www.opto22.com](http://www.opto22.com).*
- *PAC Manager is only for SNAP PAC units (both Ethernet and serial) that communicate using Ethernet. To configure legacy mistic I/O units that communicate serially with a PAC Project controller, use PAC Control. For details, see the [PAC Control User's Guide, Legacy Edition \(form 1710\)](#).*

PAC Manager is available for download from our website at [www.opto22.com](http://www.opto22.com).

This Legacy Edition includes both SNAP PAC hardware and older (legacy) hardware. If you are using only SNAP PAC hardware, use the *PAC Manager User's Guide* (form 1704) instead of this guide.

For more information on using legacy systems with the SNAP PAC System, see the *SNAP PAC System Migration Technical Note* (form 1688).

### Contents

This guide assumes that you have some familiarity with TCP/IP, UDP/IP, and Ethernet networking. If you are not familiar with these subjects, we strongly suggest you consult commercially available resources to learn about them before attempting to use these systems.

This user's guide includes the following sections:

**Chapter 1: Introduction**—Information about the guide and how to reach Opto 22 Product Support. Also includes product comparison charts.

**Chapter 2: Configuring Devices**—How to assign an IP address to your hardware, how to configure I/O units and I/O points, how to use I/O point features such as counters, watchdogs, and analog scaling; and how to send configuration data to I/O units.

**Chapter 3: Configuring Optional Functions**—Information on configuring security, communication protocols like SNMP and PPP, streaming, the Scratch Pad area, and other optional functions.

**Chapter 4: Setting Up Events and Reactions**—If you are not using PAC Control, information on configuring local reactions to local events.

**Chapter 5: Reading and Writing to Specific Devices**—How to read data directly from a specific controller or I/O unit or write directly to a controller, brain, or I/O points.

**Chapter 6: Maintaining Devices**—Changing IP addresses, upgrading firmware, and working with files on the device.

**Chapter 7: Troubleshooting**—Tips for resolving difficulties you may encounter while working in PAC Manager.

**Chapter A: Menus**—Describes PAC Manager menu commands.

**Chapter B: Dialog Boxes**—Describes the features of PAC Manager dialog boxes.

### Installing OptoOPCServer

OptoOPCServer is available as a standalone software utility or as a component of the PAC Project Software Suite, which is a comprehensive set of software tools for industrial automation, remote monitoring, and data acquisition projects in any line of business.

Installation is easy and quick, and you can download either PAC Manager or PAC Project directly from the [Opto 22 website](#).

*NOTE: The PAC Project installer includes both the Basic (free) version of the software suite and PAC Project Professional. PAC Project Professional requires a password to install.*

**To install** OptoOPCServer:

1. Download PAC Manager or PAC Project from the [Opto 22 Support > Downloads webpage](#).
2. Navigate to the folder where you downloaded PAC Manager or PAC Project, and then double-click the installation file (for example, PAC\_Manager\_<release number>.exe) to begin installation.

If you have trouble installing OptoOPCServer, contact Opto 22 Product Support (see [page 4](#)).

## Information Key

This guide includes information that applies to some types of controllers and I/O units but not to others. Sections are marked as follows to indicate the products that support them:

This text	Indicates support by this hardware
<b>PAC-R</b>	SNAP PAC R-series controllers
<b>PAC-S</b>	SNAP PAC S-series controllers
<b>SoftP</b>	SoftPAC controllers
<b>EB</b>	SNAP PAC EB brains (Ethernet)
<b>SB</b>	SNAP PAC SB brains (serial)
<b>UIO</b>	SNAP Ultimate I/O
<b>EIO</b>	SNAP Ethernet I/O
<b>SIO</b>	SNAP Simple I/O
<b>E1</b>	E1 brain boards
<b>E2</b>	E2 brain boards

## Related Documentation

You may also need some of the following documentation, depending on the system you are using and how you expect to communicate with it:

To use this	See this	Opto 22 form #
SNAP PAC R-series controllers	<a href="#">SNAP PAC R-Series Controller User's Guide</a>	1595
	<a href="#">OptoMMP Protocol Guide</a>	1465
SNAP PAC S-series controllers	<a href="#">SNAP PAC S-Series Controller User's Guide</a>	1592
	<a href="#">OptoMMP Protocol Guide</a>	1465
SoftPAC controllers	<a href="#">SoftPAC Software-based Controller for PC-based Control Data Sheet</a>	2020
SNAP PAC EB and SB brains	<a href="#">SNAP PAC Brain User's Guide</a>	1690
	<a href="#">OptoMMP Protocol Guide</a>	1465
PAC Control strategies	<a href="#">PAC Control User's Guide</a>	1700
	<a href="#">PAC Control Command Reference</a>	1701
	<a href="#">PAC Control Commands Quick Reference Card</a>	1703
Serial communication modules	<a href="#">SNAP Serial Communication Module User's Guide</a>	1191
High-density digital modules	<a href="#">SNAP High-Density Digital Module User's Guide</a>	1547
Legacy Hardware and Software		
E1 or E2 brain board	<a href="#">E1 and E2 User's Guide</a>	1563
	<a href="#">Optomux Protocol Guide</a>	1572
	<a href="#">OptoMMP Protocol Guide</a>	1465
SNAP Ultimate I/O SNAP Ethernet I/O SNAP Simple I/O	<a href="#">SNAP Ethernet-Based I/O Units User's Guide</a>	1460
	<a href="#">OptoMMP Protocol Guide</a>	1465
ioControl strategies	<a href="#">ioControl User's Guide</a>	1300
	<a href="#">ioControl Command Reference</a>	1301
	<a href="#">ioControl Commands Quick Reference Card</a>	1314

All forms are available at [www.opto22.com](http://www.opto22.com). The easiest way to find one is to search on the form number, or if you are viewing this document online, you can simply click the link.

## FOR DEVELOPERS: SNAP PAC REST API

If you're a developer who'd like to use PAC Control strategy tags in communications with other devices, the Opto 22 SNAP PAC REST API is a secure and powerful way to do just that. The API is available in SNAP PAC R-series and S-series controllers with PAC firmware R9.5a and higher. To configure HTTPS access to your PAC's RESTful server and learn how to call the API, visit [developer.opto22.com](http://developer.opto22.com).

## PRODUCT SUPPORT

If you have problems installing or using PAC Manager and cannot find the help you need in this guide or on our website, contact Opto 22 Product Support.

**Phone:** 800-TEK-OPTO (800-835-6786 toll-free in the U.S. and Canada)  
951-695-3080  
Monday through Friday,  
7 a.m. to 5 p.m. Pacific Time

*NOTE: Email messages and phone calls to Opto 22 Product Support are grouped together and answered in the order received.*

**Fax:** 951-695-3017

**Email:** [support@opto22.com](mailto:support@opto22.com)

**Opto 22 website:** [www.opto22.com](http://www.opto22.com)

When calling for technical support, you can help us help you *faster* if you provide the following information to the Product Support engineer:

- A screen capture of the Help > About dialog box showing software product and version (available by clicking Help > About in the application's menu bar).
- Opto 22 hardware part numbers or models that you're working with.
- Firmware version:
  - For SNAP controllers and brains: available in PAC Manager by clicking Tools > Inspect.
  - For *groov* EPIC processors and *groov* RIO modules: available in *groov* Manage by clicking Info and Help > About.
- Specific error messages you saw.
- Version of your computer's operating system.
- For PAC Control, PAC Display, or PAC Manager, you may be requested to provide additional information, such as log or dump files. You can find these files in a support files sub-folder:
  - a.** On your Windows Desktop, double-click the PAC Project 10.4 folder.
  - b.** Double-click Support Files.
  - c.** Double-click on the appropriate shortcut to open the sub-folder containing the requested files.

**Note:** PAC Control, PAC Display, and PAC Manager create some of the sub-folders in the event of a crash. A shortcut may not work if these programs have not crashed.

## OPTO 22 FEATURE COMPARISON CHART

This table compares SNAP PAC controllers and brains using PAC firmware R9.5 and PAC Project R9.6 software (or higher).

FEATURE		SNAP PAC Controllers						SNAP PAC Brains				
		SW	Standalone		Rack-mounted			Ethernet		Serial		
		SoftPAC	SNAP-PAC-S1 SNAP-PAC-S1-FM	SNAP-PAC-S2	SNAP-PAC-R1 SNAP-PAC-R1-FM	SNAP-PAC-R1-B	SNAP-PAC-R2 SNAP-PAC-R2-FM	SNAP-PAC-EB1 SNAP-PAC-EB1-FM	SNAP-PAC-EB2 SNAP-PAC-EB2-FM	SNAP-PAC-SB1	SNAP-PAC-SB2	
Runs PAC Control strategies		●	●	●	●	●	●					
Maximum PAC Control charts running at once (plus host task)		64	32	32	16	16	16					
Communication	Two independent Ethernet network interfaces (two IP addresses)	a	●	●	●	●	●					
	Two switched Ethernet network interfaces (one IP address) for multi-drop configuration							●	●			
	Total number of RS-232 serial ports	b	2	4 <sup>c</sup>	1	1	1	0	0	0	0	
	Total number of RS-485 serial ports	b	1	4 <sup>c</sup>	0	0	0	0	0	1	1	
Protocols	TCP/IP, UDP/IP	●	●	●	●	●	●	●	●			
	EtherNet/IP™ (Allen-Bradley® RSLogix® systems and others)		●	●	●	●	●	●	●			
	Modbus®/TCP (slave) <sup>d</sup>		●	●	●	●	●	●	●			
	OPC driver support	●	●	●	●	●	●	●	●	● <sup>f</sup>	● <sup>f</sup>	
	RESTful API		●	●	●	●	●					
	HTTP/HTTPS		●	●	●	●	●					
	OptoMMP memory-mapped protocol	● <sup>g</sup>	●	●	●	●	●	●	●	●	●	
	SNMP (network management)		●	●	●	●	●	●	●			
	FTP server, file system		●	●	●	●	●	●	●			
	FTP client	●	●	●	●	●	●					
SMTP (email client with authentication and attachments)		●	●	●	●	●						
Supports Node-RED via SNAP-PAC nodes and RESTful API			●	●	●	●						
Direct access to hard drive & network drives (Dropbox®, etc.)		●										
Realtime clock		a	●	●	●	●	●	●	●	●	●	
Backup battery (recharges when brain has power) <sup>h</sup>			●	●	●	●	●	●	●	●	●	
Physical RAM (MB)		a	32		16			16		16		
RAM available for Strategy (MB)		64	16		4			--		--		
Battery-backed RAM (MB)		8	8		2			--		--		
Flash memory (MB)		i	16		8			8		8		
Removable data storage (microSD card slot)		a	32 GB max. <sup>k</sup>			32 GB max. <sup>k</sup>						
32-bit processor		a	●	●	●	●	●	●	●	●	●	
Floating-point unit (FPU)		a	●	●	●	●	●					
Power requirements		a	8–32 VDC <sup>l</sup> 10 W–11.3 W max			5.0 to 5.2 VDC @ 1.2–1.5 A			5.0 to 5.2 VDC @ 750 mA–1.0 A			
Operating Temperature in degrees C		a	-20 to 60		-20 to 60			-20 to 60				
Storage Temperature in degrees C			-40 to 85		-40 to 85			-40 to 85				
Humidity (non-condensing)		a	0–95%		0–95%			0–95%				
Compatible brains <sup>n</sup>	SNAP PAC EB brains	●	●	●	●	●	●					
	SNAP PAC SB brains		●	●								

OPTO 22 FEATURE COMPARISON CHART

FEATURE		SNAP PAC Controllers						SNAP PAC Brains				
		SW	Standalone		Rack-mounted			Ethernet		Serial		
		SoftPAC	SNAP-PAC-S1 SNAP-PAC-S1-FM	SNAP-PAC-S2	SNAP-PAC-R1 SNAP-PAC-R1-FM	SNAP-PAC-R1-B	SNAP-PAC-R2 SNAP-PAC-R2-FM	SNAP-PAC-EB1 SNAP-PAC-EB1-FM	SNAP-PAC-EB2 SNAP-PAC-EB2-FM	SNAP-PAC-SB1	SNAP-PAC-SB2	
Combination controller and I/O processor					●	●	●					
Mounts on SNAP PAC I/O mounting rack		n/a	n/a		●		●	●	●	●	●	
Mounts on SNAP B-series I/O mounting rack		n/a	n/a			●						
Maximum number of modules allowed on largest rack: Any mix of 16 digital, 16 analog, and 8 serial		n/a	n/a		● <sup>o</sup>	● <sup>o</sup>	●	●	●	● <sup>p</sup>	● <sup>p</sup>	
Digital I/O point features	Input latching	n/a	n/a		●	●	●	●	●	●	●	
	On/off status			●	●	●	●	●	●	●	●	
	Watchdog timer			●	●	●	●	●	●	●	●	
	High-speed counting (up to 20 kHz) <sup>q</sup>			●	●		●		●		●	
	Quadrature counting <sup>r</sup>			●	●		●		●		●	
	On-pulse & off-pulse measurement <sup>q</sup>			●	●		●		●		●	
	Frequency & Period measurement <sup>q</sup>			●	●		●		●		●	
	TPO (time-proportional output)			●	●	●	●	●	●	●	●	●
	Digital totalizing <sup>q</sup>			●	●	●	●	●	●	●	●	●
Pulse generation (continuous square wave, N pulses, on-pulse, off-pulse)	●	●	●	●	●	●	●	●	●	●		
Analog I/O point features	Thermocouple linearization (32-bit floating point for linearized values)	n/a	n/a		●	●	●	●	●	●	●	
	Minimum/maximum values			●	●	●	●	●	●	●	●	
	Offset and gain			●	●	●	●	●	●	●	●	
	Scaling			●	●	●	●	●	●	●	●	
	TPO (Time-proportional output) <sup>s</sup>			●	●	●	●	●	●	●	●	
	Output clamping			●	●	●	●	●	●	●	●	
	Filter weight			●	●	●	●	●	●	●	●	
	Watchdog timer			●	●	●	●	●	●	●	●	
	Analog totalizing <sup>t</sup>			●	●	●	●	●	●	●	●	
Ramping <sup>t</sup>	●	●	●	●	●	●	●	●				
PID logic (maximum 96 PID loops per controller or brain)					●	●	●	●	●	●	●	
Data logging					●	●	●	●	●	●	●	
Digital events, alarm events, serial events					●	●	●	●	●	● <sup>u</sup>	● <sup>u</sup>	
Event messaging					●	●	●	●	●			
UDP streaming of I/O data to host					●	●	●	●	●			
I/O point data mirroring and memory map copying					●	●	●	●	●			



FEATURE	SNAP PAC Controllers						SNAP PAC Brains			
	SW	Standalone		Rack-mounted		Ethernet		Serial		
	SoftPAC	SNAP-PAC-S1 SNAP-PAC-S1-FM	SNAP-PAC-S2	SNAP-PAC-R1 SNAP-PAC-R1-FM	SNAP-PAC-R1-B	SNAP-PAC-R2 SNAP-PAC-R2-FM	SNAP-PAC-EB1 SNAP-PAC-EB1-FM	SNAP-PAC-EB2 SNAP-PAC-EB2-FM	SNAP-PAC-SB1	SNAP-PAC-SB2
<p>a As provided by the Microsoft Windows computer the software runs on.</p> <p>b SoftPAC cannot communicate through serial ports on the PC.</p> <p>c Serial ports are software configurable for RS-232 or RS-485.</p> <p>d PAC firmware &gt;=R9.4b, 8 max connections. Lower firmware, 2 max connections.</p> <p>e Requires OptoOPCServer or third-party compatible OPC server.</p> <p>f Available with OptoOPCServer and PAC Control, through a SNAP PAC controller.</p> <p>g SoftPAC includes Status Read, Status Write, and Scratch Pad memory map areas.</p> <p>h Models manufactured before August 2007 and S1s with serial numbers 625653 and lower have user-replaceable backup batteries. See original user's guide.</p> <p>i Flash memory function implemented via a file; size is limited only by disk space.</p> <p>k PAC firmware 9.4a and loader 6.1a or higher. S-series with microSD &amp; manufacture date older than 06/14 supports max. 2 GB microSD.</p> <p>l Units with serial numbers lower than 500,000 have an 8–24 VDC input voltage rating. <i>Verify voltage on the unit's faceplate before applying power.</i></p>	<p>n For compatibility with legacy Opto 22 hardware, see form #1693.</p> <p>o SNAP-PAC-R1s with serial numbers lower than 600,000, and all SNAP-PAC-R1-Bs: limited to eight 4-point digital modules per rack.</p> <p>p Not supported: serial, motion control, Profibus, &amp; Wiegand modules.</p> <p>q Four-channel modules only; not high-density modules.</p> <p>r Requires a SNAP-IDC5Q quadrature input module.</p> <p>s Requires a SNAP analog TPO module (SNAP-AOD-29).</p> <p>t Requires a SNAP PAC controller and PAC Control commands.</p> <p>u Does not support serial events.</p>									

## OPTO 22 FEATURE COMPARISON CHART







Feature	Current Hardware														Legacy Hardware																			
	SoftPAC Software-based PAC	SNAP PAC Controller						SNAP PAC Brain							E1 Brain Board	E2 Brain Board	SNAP Simple	SNAP Ethernet		SNAP Ultimate														
		SNAP-PAC-S1	SNAP-PAC-S1-FM	SNAP-PAC-S1-W	SNAP-PAC-S2	SNAP-PAC-S2-W	SNAP-PAC-R1	SNAP-PAC-R1-B	SNAP-PAC-R1-FM	SNAP-PAC-R1-W	SNAP-PAC-R2	SNAP-PAC-R2-FM	SNAP-PAC-R2-W	SNAP-PAC-EB1			SNAP-PAC-EB1-FM	SNAP-PAC-EB1-W	SNAP-PAC-EB2	SNAP-PAC-EB2-FM	SNAP-PAC-EB2-W	SNAP-PAC-SB1	SNAP-PAC-SB2	G4EB2	SNAP-ENET-S64	SNAP-B3000-ENET	SNAP-ENET-RTC	SNAP-ENET-D64	SNAP-UP1-ADS	SNAP-UP1-D64	SNAP-UP1-M64			
		n/a																																
n/a																																		
Data logging in the brain	n/a						●	●	●	●	●	●	●	●	●	●	●	●	●	●	●	●	●	●		●		●		●		●		●
I/O channel data mirroring							●	●	●	●	●	●	●	●	●	●	●	●	●	●	●	●	●	●		●		●		●		●		●
Memory map data copying							●	●	●	●	●	●	●	●	●	●	●	●	●	●	●	●	●	●		●		●		●		●		●
Scratch Pad area (peer-to-peer communication)																																		
Bits	●●	●●	●●	●●	●●	●●	●●	●●	●●	●●	●●	●●	●●	●●	●●	●●	●●	●●	●●	●●	●●	●●	●●	●●		●	●	●●	●●	●●	●●	●●	●●	●●
Floats																																		
Strings	●●	●●	●●	●●	●●	●●	●●	●●	●●	●●	●●	●●	●●	●●	●●	●●	●●	●●	●●	●●	●●	●●	●●	●●				●●	●●	●●	●●	●●	●●	●●
Integers (32 bit)	●●	●●	●●	●●	●●	●●	●●	●●	●●	●●	●●	●●	●●	●●	●●	●●	●●	●●	●●	●●	●●	●●	●●	●●				●●	●●	●●	●●	●●	●●	●●
Integers (64 bit)	●●	●●	●●	●●	●●	●●	●●	●●	●●	●●	●●	●●	●●	●●	●●	●●	●●	●●	●●	●●	●●	●●	●●	●●				●●	●●	●●	●●	●●	●●	●●
Realtime clock (RTC)	10	●	●	●	●	●	●	●	●	●	●	●	●	●	●	●	●	●	●	●	●	●	●	●		□ 8		●		●		●		●

# 2: Configuring Devices

## INTRODUCTION

Follow the steps in this chapter to assign IP addresses to Opto 22 devices on an Ethernet network. (Addressing information for SNAP PAC SB serial brains is set on the brain itself. For details, see the [SNAP PAC Brains User's Guide](#), form 1690.) This chapter also includes steps for configuring I/O unit points and features. I/O points must be configured before you can read or write to them.

This chapter assumes that you have already installed the hardware and software according to steps in the device's user's guide. (See ["Related Documentation" on page 3](#).)

If you are using a wireless or modem connection, or if you are using event messages, email, streaming, the Scratch Pad area for peer-to-peer communication, or SNMP for communicating with enterprise management systems, also see Chapter 3, which shows you how to set up these optional functions. All this information goes in the configuration file that PAC Manager uploads to I/O units.

## WHEN TO USE PAC MANAGER AND PAC CONTROL

If you will be running a PAC Control strategy on a SNAP PAC or SNAP Ultimate I/O System to control I/O units, you may be wondering when to use PAC Manager versus when to use PAC Control. These two tools serve different purposes, but some of their functionality overlaps.

*NOTE: PAC Manager cannot be used to configure groov I/O units or mistic I/O units.*

- *For groov I/O units, use groov Manage.*

- For *mistic* I/O units, use PAC Control.

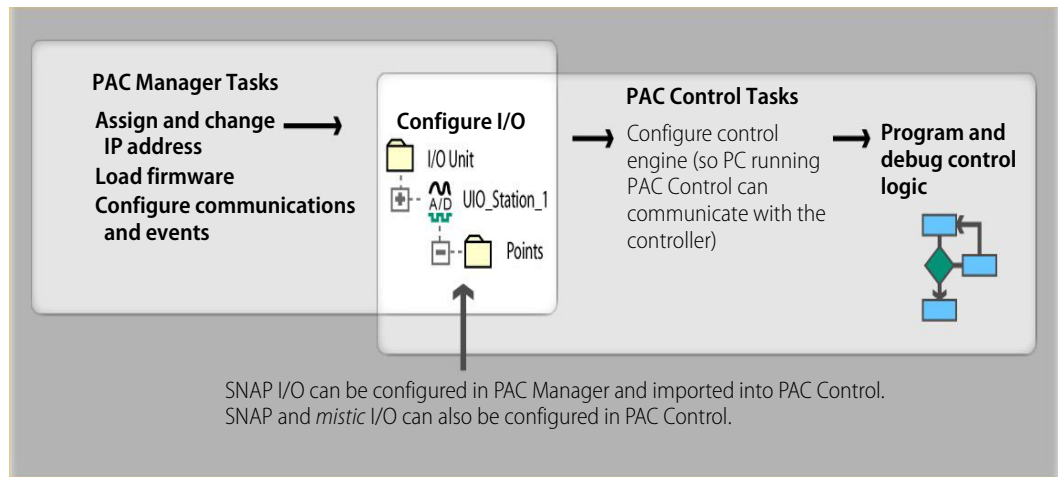

### Choosing a Configuration Tool for SNAP I/O

About E1 and E2 brain boards: You can configure E1s and E2s like any other I/O unit if you have E1/E2 firmware R1.2a (and higher) and PAC Project 9.5000 (and higher). Also, if a SNAP PAC controller communicates with the E1 or E2, the controller must have PAC firmware R9.5a (or higher) to use this simplified configuration method. If you are not using these firmware and software versions (or if you prefer to use the previous method to reconfigure existing E1s or E2s), see [I/O Configuration for E1 an E2 Brain Boards \(form 1576\)](#).

For most I/O units, if you are already in PAC Control, configuration is easier there and you can use the loopback IP address for SNAP PAC R-series or SNAP Ultimate I/O units controlling themselves. However, some functions for I/O units cannot be configured in PAC Control.

If you use PAC Manager, you can save your configuration to a file, load it to multiple I/O units at once, and use it for referencing points in OPC. However, you cannot use the loopback address in PAC Manager and you cannot use PAC Manager for *mistic* I/O units.

Choose your configuration tool based on what you need to do:

Use PAC Control for I/O configuration if	Use PAC Manager for SNAP I/O configuration if
<ul style="list-style-type: none"> <li>• You have only one I/O unit or I/O unit configurations are different.</li> <li>• You are configuring <i>mistic</i> I/O units.</li> <li>• The strategy will run on SNAP PAC R-series or SNAP Ultimate I/O units that are controlling themselves using the loopback IP address, 127.0.0.1</li> <li>• You are using an Ethernet network for communications (or using a SNAP PAC controller with an SB brain).</li> <li>• The strategy handles all logic; you are not also configuring events and reactions on I/O units.</li> </ul>	<ul style="list-style-type: none"> <li>• You have multiple I/O units whose configurations are exactly the same or similar.</li> <li>• You are using a modem connection (PPP) or SNMP.</li> <li>• You are using event messages or email.</li> <li>• You are configuring events and reactions on the I/O unit in addition to strategy logic.</li> <li>• You are not using PAC Control.</li> </ul>

Whichever tool you use for configuring I/O, be aware of the impact if you later change configuration. For example, if you configure I/O in PAC Manager, and then download the configuration file to I/O units, and then later add a point in PAC Control, remember that your configuration file won't contain the new point.



## ASSIGNING AN IP ADDRESS

*NOTE: If you are using redundant controllers with the SNAP PAC Redundancy Option Kit and PAC Project Professional R9.1, do not use PAC Manager to assign IP addresses. Instead, use the PAC Redundancy Manager.*

PAC-S  
PAC-R  
EB  
UIO  
EIO  
SIO  
E1  
E2

### About IP Addresses

Each Ethernet-based device (controller, brain board, or brain) ships from the factory with a unique hardware Media Access Control (MAC) address and with a default IP address of 0.0.0.0, which is invalid. Each device must have a valid IP address and subnet mask so that it can communicate on the network.

When installed and first turned on, a SNAP PAC controller or brain sends out a BootP broadcast requesting an IP address. You respond to the broadcast by using PAC Manager to assign a *static* (non-changing) IP address. These devices must be given a fixed, static IP address, because you communicate with them using the IP address.

Opto 22 Ethernet-based hardware falls into two categories that differ in the way IP addresses are assigned:

- **SNAP PAC controllers and brains, SNAP Ultimate, SNAP Ethernet, and SNAP Simple I/O**—When installed and first turned on, each of these devices sends out a BootP broadcast over the wired Ethernet interface requesting an IP address. You respond to the broadcast by using PAC Manager to assign a *static* IP address. These devices must be given a fixed, static IP address, because you communicate with them using the IP address. See steps in [“Assigning IP Addresses to SNAP PAC, UIO, EIO, and SIO” on page 15](#).
- **E1 and E2 brain boards**—When installed and first turned on, each E1 or E2 sends out a DHCP (Dynamic Host Configuration Protocol) broadcast requesting an IP address. Any DHCP server on the network can respond and assign a dynamic IP address to the brain board.

In most cases, you will need to change the E1’s or E2’s dynamic IP address to a *static* IP address. You **must** give E1s and E2s static IP addresses if you are using PAC Project software (PAC Control, PAC Display, OptoOPCServer, or OptoDataLink), the OptoMMP Software Development Kit, or the Optomux Protocol Drivers & Utilities to communicate with them.

However, if your application can communicate with E1s and E2s using host names, and your E1s and E2s are on a network that has a DHCP server that automatically updates a DNS (Dynamic Name Service) server, you do not have to assign a static IP address. You will communicate with the brain board using its host name.

Whether you are using a dynamic or a static IP address for E1 and E2 brain boards, see the steps in [“Assigning IP Addresses to E1 and E2 I/O Units” on page 21](#).

PAC-S  
PAC-R  
EB  
UIO  
EIO  
SIO

### Assigning IP Addresses to SNAP PAC, UIO, EIO, and SIO

Before using a PC or laptop computer to assign IP addresses, perform the following checks:

- Will your controller or brain run on a network that has a DHCP server? Dynamic Host Configuration Protocol (DHCP) servers can automatically respond to BootP requests and assign a “dynamic” (changeable) IP address to the requesting device, but SNAP PAC controllers and brains must have static IP addresses. If your network has a DHCP server, Opto 22 recommends you connect the device directly to your computer with a network cable (even if the device is a Wired+Wireless model), and then assign the IP address. After the device has a static IP address, you can connect it to the network.
- If the computer has an active wireless network connection, disable the wireless connection and connect to your Opto 22 device via a wired connection. If you are connecting to a wireless Opto 22 device, you will configure the wireless connection later.
- If the computer has multiple network interface controller (NIC) cards, disable all of them except for the one that will be connecting to your Opto 22 device. You can re-enable them after you complete these steps.

- If you need to modify the computer's network interface settings, you must be logged in with administrative rights.
- Temporarily disable firewalls on the computer running PAC Manager. Firewalls, such as the ones that come with some anti-virus software programs and the built-in firewall in Windows, can prevent PAC Manager from receiving BootP broadcasts. (Firewalls in a router should not be a problem.)  
If disabling firewalls is not an option, configure a firewall exception for PAC Manager.
  - To configure a firewall exception in your system's anti-virus software, see the manufacturer's instructions.
  - To configure a firewall exception in Windows, open Control Panel > System and Security > Windows Firewall > Allow an app or feature through Windows Firewall and add PAC Manager to the list of allowed programs.

You can reenable the firewall (or remove the firewall exception) after you have assigned the IP addresses.

All SNAP PAC controllers and brains R-series and S-series controllers, and SNAP PAC EB, SNAP Ultimate, SNAP Ethernet, and SNAP Simple I/O units must be assigned a **unique, static IP address**. If the network you're using has a Dynamic Host Configuration Protocol (DHCP) server, either assign a static IP address **before** connecting the device to the network (preferred), or disable the server. (These servers may respond to BootP requests and assign a dynamic address.)

**Wired+Wireless models:** These devices have a wireless LAN interface as well as wired interfaces, but they send a BootP request only on the wired interface. First, follow the steps below to connect to them over a wired network and assign their primary IP address. Later, you can configure the wireless interface.

### TIP:

For multiple devices, see [page 27](#).

If you are adding an I/O segment to an existing Ethernet network, your network administrator must provide static IP addresses and subnet masks for the I/O units. If you are creating an independent, dedicated Ethernet network just for I/O, you can choose your own addresses.

1. Make sure that the Opto 22 hardware is installed according to directions in its user's guide, and that the PAC Manager software is installed on the computer.
2. Make sure you know the IP address, subnet mask, and MAC address of each device that will receive an IP address.

The MAC address is on a label on the side of the controller or brain.

SNAP PAC S-series and R-series controllers each have two separate Ethernet network interfaces; wired+wireless models have an additional wireless interface. Each interface has its own MAC address and must be on a separate logical network. The interface's logical network is determined by its IP address and subnet mask. For details, see the [Simplified IP Addressing Technical Note](#) (form 1362) or get help from your system administrator.

Only Ethernet 1 sends a BootP request. Once you have assigned this primary IP address, you can assign Ethernet 2 (the secondary address) and the wireless address, if applicable. To assign an address to Ethernet 2, see [page 30](#); for wireless configuration, see [page 35](#).

SNAP PAC brains are different. Since their two Ethernet network interfaces act as an Ethernet switch and share the same IP address, it doesn't matter which interface is attached to the network. The BootP broadcast comes through both. On a wired+wireless EB brain, the wireless interface has a separate IP address. After you assign the primary IP address for the wired network, see [page 35](#) for wireless configuration.

3. Turn on the Opto 22 device(s).
4. If PAC Manager isn't already open it, start it.<sup>1</sup>

---

<sup>1</sup>Click the Windows Search button and type PAC Manager 10.4.

The PAC Manager main window opens.

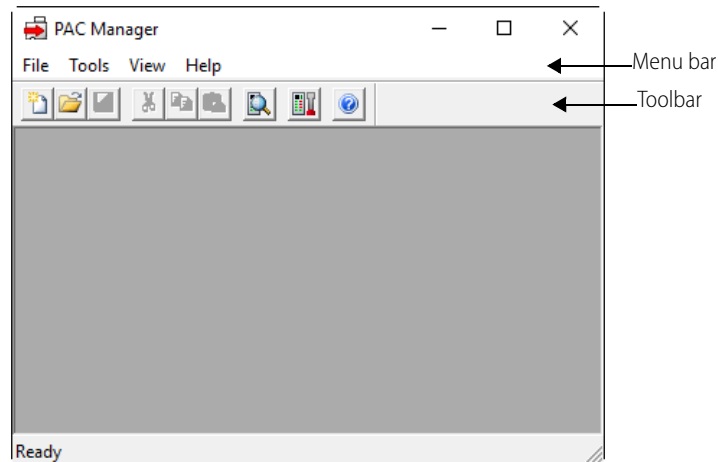

5. In PAC Manager's menu bar, click Tools > Assign IP Address.

The Assign IP Address dialog box opens. Any Opto 22 Ethernet-based devices without IP addresses that are on the computer's network segment appear in the list of units requesting IP addresses.

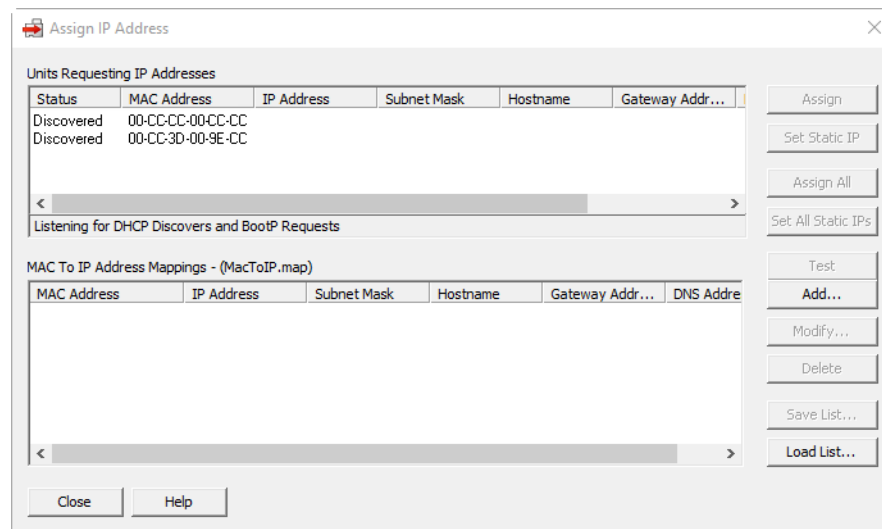

If no MAC address appears, check the following:

- Is the Opto 22 device turned on?
- Is it correctly connected to the computer using a crossover cable or correctly connected to an Ethernet switch using a straight-through cable? (For which type of cable to use, see Step 3, ["Replacing Damaged Firmware."](#))
- Is the computer's network card configured with the same subnet mask as the device? See the computer's user's guide for networking information.
- Does the device already have an IP address? If you want to change the IP address, see [page 223](#).
- Is the device booting to the loader rather than the firmware? If so, see the device's user's guide for more information on STAT LED blink codes.
- Does the computer have firewall software that blocks network broadcasts? If so, disable the firewall software.

## ASSIGNING AN IP ADDRESS

- Have you performed all of the checks in [“Assigning IP Addresses to SNAP PAC, UIO, EIO, and SIO” on page 15?](#)
6. Double-click the MAC address of the device in the list that matches the device you are assigning the IP address to.

*CAUTION: PAC Manager lists ALL Opto 22 devices sending BootP broadcasts. Assign IP addresses only to the devices that are yours.*

The Mapping dialog box opens.

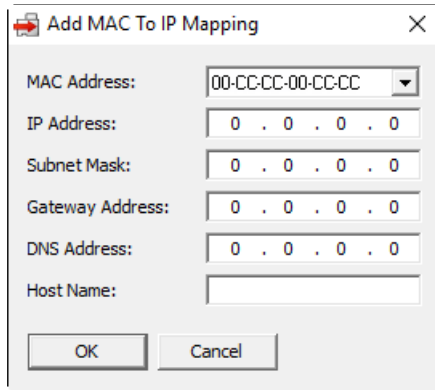

7. Enter the IP Address and the Subnet Mask for the device. If the device will be communicating with a device on another subnet, enter the Gateway (router) address. If it will communicate only on the local subnet, leave the gateway address all zeros (0.0.0.0). Leave the DNS address at 0.0.0.0 and the Host Name field blank.

**WARNING!** Each device on your network, including computers, routers, controllers, brains, and so on, must have a unique IP address. Failure to assign unique IP addresses may cause catastrophic network or hardware failures. If you don't know which IP addresses are safe to use, check with your system administrator.

8. When the IP address, subnet mask, and other fields are correct, click OK.

The new IP address information appears in the upper list in the dialog box, and the device's status changes to Mapped. The address information also appears in the lower list to show that this device has been mapped to this address.

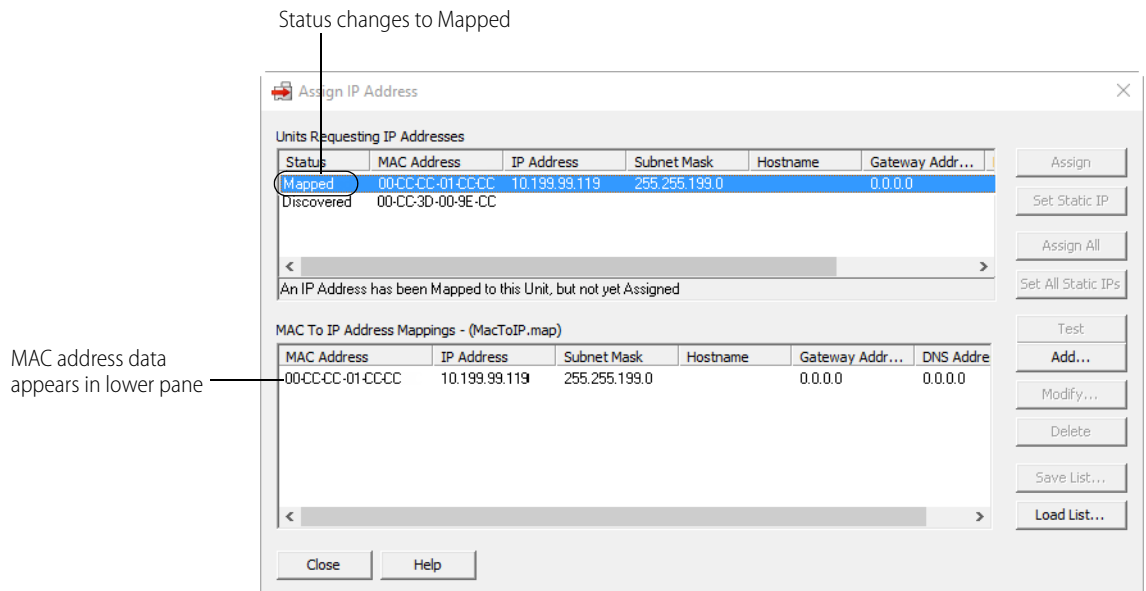

9. With the device still highlighted, click Assign.

The address is saved to flash memory, and the status changes to IP Address Assigned.

Status changes to IP Address Assigned.

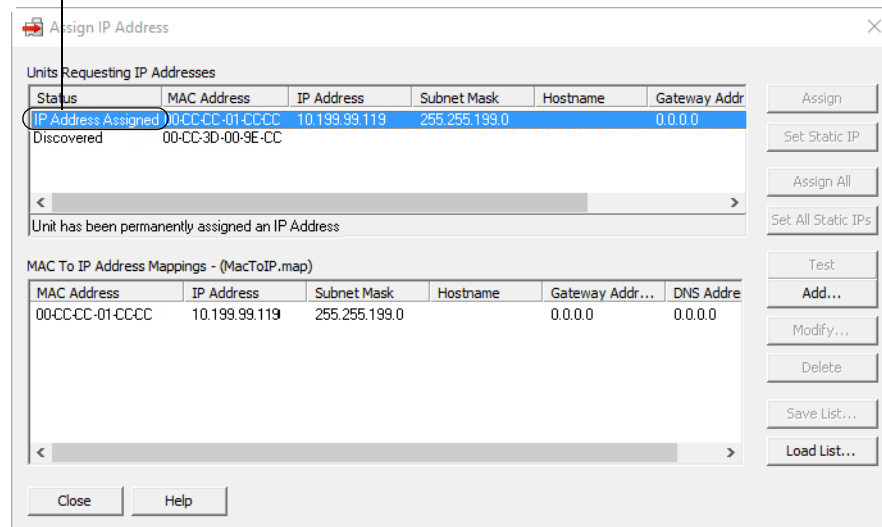

- Once a device's status becomes Assigned or Static, you can no longer change its IP address information from this dialog box. To change the address, use Tools > Change IP Settings. (For details, see [page 223](#).)
- If the device's status changes from Mapped to IP Address Assigned, and then back to Mapped, and the STAT LED on the device continues to flash (instead of steadily glowing green) this means the IP address was not successfully assigned. This often happens when you try to assign the IP address by

using a wireless connection, rather than a wired connection. Connect to the device with a cable and try again, and verify that you've performed all of the checks listed in ["Assigning IP Addresses to SNAP PAC, UIO, EIO, and SIO" on page 15](#).

- To verify that the IP address has been assigned successfully, highlight the device in the upper list and click Test.

A command prompt window opens and the IP address is automatically tested using the PING command. You should see a reply similar to the following:

```

C:\Windows\system32\cmd.exe

Pinging 10.192.54.110 with 32 bytes of data:
Reply from 10.192.54.110: bytes=32 time=1ms TTL=255
Reply from 10.192.54.110: bytes=32 time<1ms TTL=255
Reply from 10.192.54.110: bytes=32 time<1ms TTL=255
Reply from 10.192.54.110: bytes=32 time<1ms TTL=255

Ping statistics for 10.192.54.110:
    Packets: Sent = 4, Received = 4, Lost = 0 (0% loss),
    Approximate round trip times in milli-seconds:
        Minimum = 0ms, Maximum = 1ms, Average = 0ms

Press any key to continue . . . _
  
```

If you don't see a reply, make sure the subnet mask you've assigned matches the subnet mask on your computer.

- For future reference, write the IP address next to the MAC address on the white sticker provided on the device.
- Repeat steps 6 through 11 for any other devices in the list that you are responsible for.
- To save the list of IP address and MAC address mappings (the lower list in the dialog box) for future reference, click the Save List button. Navigate to the folder where you want to save the file, enter a filename, and then click Save.

The address information is saved. You can load this information into PAC Manager later if you need to see it.

### What's Next?

- For a **SNAP PAC R-series controller**, continue to [page 30](#) to assign an IP address to Ethernet 2.
  - For a **Wired+Wireless model**, configure the wireless LAN interface ([page 35](#)). Then continue with ["Creating an I/O Unit Configuration File" on page 39](#).
- For a **Wired+Wireless EB brain**, configure the wireless LAN interface on [page 35](#). Then continue with ["Creating an I/O Unit Configuration File" on page 39](#).
- For a **SNAP PAC EB, SNAP Ultimate, SNAP Ethernet, or SNAP Simple brain**, continue with ["Creating an I/O Unit Configuration File" on page 39](#).
- For a **SNAP PAC S-series controller**, choose from the following:
  - To set up security on the wired network, see [page 94](#).
  - (SNAP PAC only) To assign an IP address to Ethernet 2 on a wired network, see [page 30](#).
  - (Wired+Wireless models only) To configure the wireless LAN interface, see [page 35](#).
- To create PAC Control strategies to run on the controller, see the [PAC Control User's Guide](#) (form 1700). Information on peer-to-peer communication using the Scratch Pad area of the controller can be found in the [PAC Control User's Guide](#); see the "peer-to-peer communication" in the index. See also the [PAC Control Command Reference](#) (form 1701).

- **To work with the controller's file system, microSD card, and FTP**, see [page 239](#).

E1  
E2

## Assigning IP Addresses to E1 and E2 I/O Units

Remember that any E1 or E2 used with PAC Project software (PAC Control, PAC Display, OptoOPCServer, or OptoDataLink) or applications built with the OptoMMP Software Development Kit, or the Optomux Protocol Drivers & Utilities, must be assigned a static IP address, because you will use the IP address to communicate with the device. [Discovering the IP Address](#)

*TIP: For multiple devices, see [Assigning IP Addresses to Multiple Devices](#).*

1. Make sure you know the MAC address of the E1 or E2.  
The MAC address is printed on a white sticker on the brain board.
2. Make sure that the Opto 22 hardware is installed according to directions in its user's guide.
3. Turn on the E1 or E2 I/O unit.  
The I/O unit sends a DHCP broadcast. The broadcast is usually answered by a DHCP server on the network, and the server assigns a dynamic IP address.
4. On a PC on the same network, open a Command Prompt. Type `ping` and the host name of the I/O unit.  
The default host name for any E1 or E2 is `OPTO-` followed by the last six digits of the brain board's MAC address. For example, an E1 with a MAC address of 00-a0-3d-00-09-35 would have this default host name: `OPTO-00-09-35`  
So in the command prompt, you would type: `ping OPTO-00-09-35`  
If the ping command works, you know that the I/O unit has been assigned an IP address. The current IP address of the device is returned to you in the reply.
5. Choose one of the following:
  - If the ping command worked and you need to assign a static IP address, write down the IP address from the ping reply. Continue with ["Changing the IP Address to a Static IP" on page 23](#).
  - If the ping command worked and you will communicate with the device using only its host name rather than its IP address, the device is ready to use. Stop here. (You can change the host name if necessary. See ["Changing Status Data" on page 155](#).)
  - If the ping command did not return a reply, continue with the next step.

*CAUTION: You may have problems continuing with the next step if your network includes old Opto 22 SNAP Ethernet brains with firmware version R1.3m or earlier, or controllers with M4SENET-100 adapter cards at firmware version R1.3k or earlier. These brains and adapter cards may have to be rebooted if you use the discovery feature in the next steps.*

*To avoid this problem, either update the older devices to newer firmware before continuing, or ask your network administrator to provide you with the dynamic IP address currently assigned to the E1 or E2, and then skip to ["Changing the IP Address to a Static IP" on page 23](#).*
6. If the ping command did not return a reply, make sure that PAC Manager software is installed on a PC on the same network as the brain board.
7. On the PC, choose Start > Programs > Opto 22 > PAC Project Software > PAC Manager.

The PAC Manager main window opens.

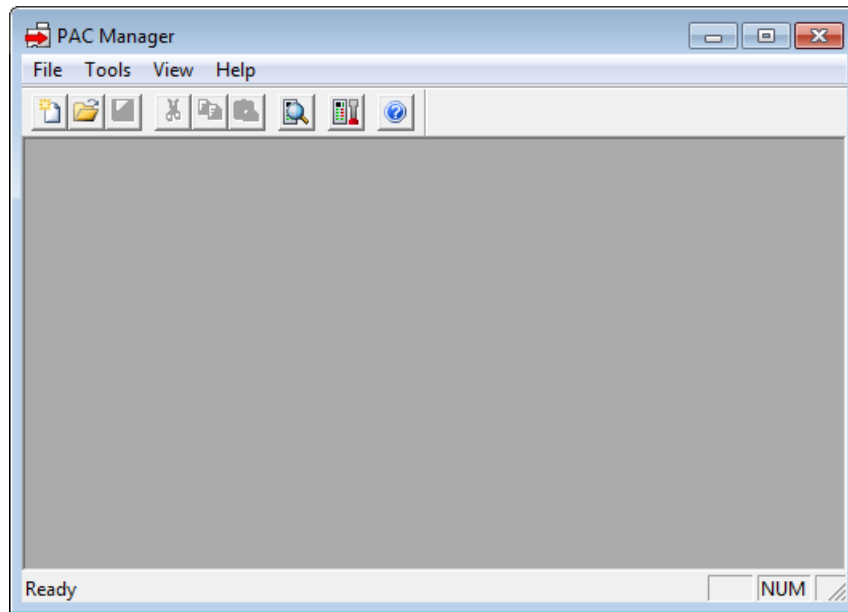

8. Choose Tools > Find Opto 22 MMP Devices.

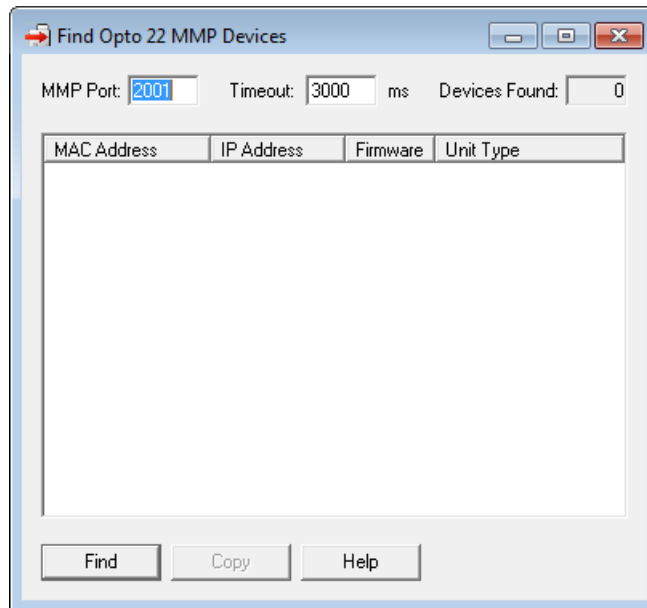

9. Click Find.  
PAC Manager discovers all Ethernet-based Opto 22 memory-mapped devices on the network and lists their MAC addresses and IP addresses. Opto 22 memory-mapped devices include SNAP PAC controllers and brains, SNAP Ethernet, SNAP Ultimate, and SNAP Simple I/O units, and E1 and E2 I/O units. (Opto 22



M4-series controllers with Ethernet cards are not included. SNAP PAC SB brains are not found because they are serial based.)

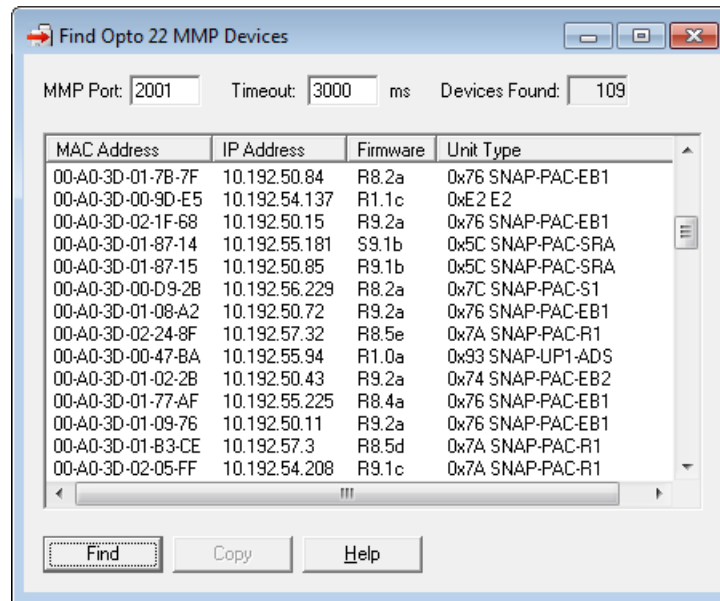

10. Find the device's MAC address in the left column and write down its IP address from the next column. Make sure you have the correct MAC address!
11. Close the dialog box.
12. Continue with the next section, ["Changing the IP Address to a Static IP."](#)

**E1**  
**E2**

### Changing the IP Address to a Static IP

1. Make sure you know the current IP address of each device as well as the static IP address number and subnet mask to assign to it.  
You should already know the current IP address from steps in the previous section, ["Remember that any E1 or E2 used with PAC Project software \(PAC Control, PAC Display, OptoOPCServer, or OptoDataLink\) or applications built with the OptoMMP Software Development Kit, or the Optomux Protocol Drivers & Utilities, must be assigned a static IP address, because you will use the IP address to communicate with the device. Discovering the IP Address"](#) on page 21. Work with your network administrator to determine the static IP addresses to use for your Ethernet network.
2. If PAC Manager is not open, start it. (For instructions, see the footnote on [page 16](#).)

- In PAC Manager’s menu bar, click Tools > Change IP Settings.

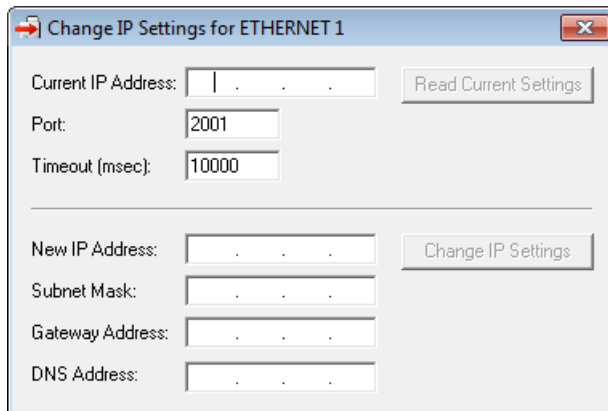

- From the PAC Manager menu bar, click Tools > Assign IP Address. The following dialog box opens. Any Opto 22 Ethernet-based devices without IP addresses that are on the PC’s network segment appear in the list of units requesting IP addresses:

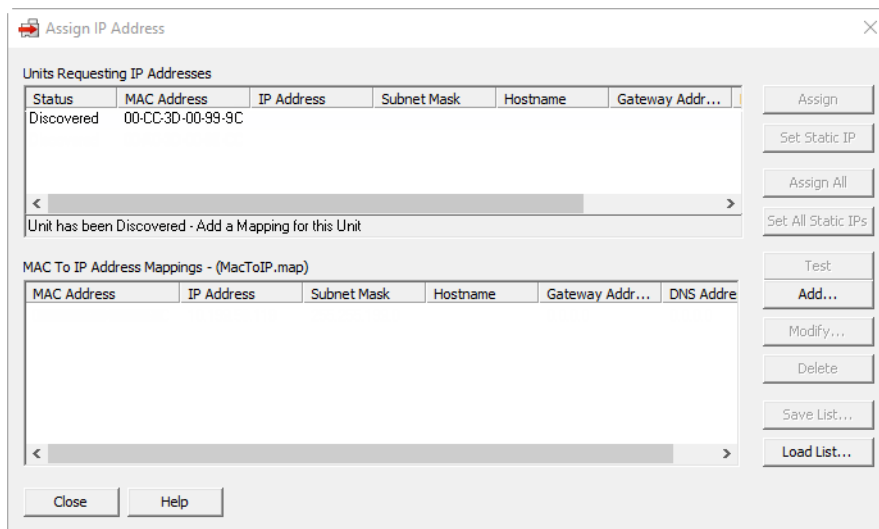

If no MAC address appears, check the following:

- Is the Opto 22 device turned on?
  - Is it correctly connected to the PC using a crossover cable or correctly connected to an Ethernet hub using a straight-through cable? (For which type of cable to use, see Step 3, “[Replacing Damaged Firmware.](#)”)
  - Is the PC on the same subnet as the device? See its user’s guide for networking information.
  - Does the device already have an IP address? If you want to change the IP address, see [page 223](#).
  - Is the device booting to the loader rather than the firmware? See its user’s guide for more information.
  - Does the PC have firewall software that blocks network broadcasts? If so, disable the software.
- Double-click the MAC address of the device in the list.

*CAUTION: PAC Manager lists ALL Opto 22 devices sending BootP or DHCP broadcasts. Assign IP addresses only to the ones you know are yours! Hint: E1s and E2s show a host name that is OPTO- plus the last six digits of the MAC address (for example: OPTO-00-9D-75).*

The Mapping dialog box opens.

6. Enter the IP Address and the Subnet Mask for the device. If it will be talking to a device on another subnet, enter the Gateway (router) address. If it will talk only on the local subnet, leave the gateway address all zeros (0.0.0.0). Leave the DNS address at 0.0.0.0 and the Host Name field as is, since you will not be communicating with the I/O unit using its host name.

*WARNING! Each device on your network, including computers, routers, controllers, brains, and so on, must have a unique IP address. Failure to assign unique IP addresses may cause catastrophic network or hardware failures. If you don't know which IP addresses are safe to use, check with your system administrator.*

7. When the IP address, subnet mask, and other fields are correct, click OK.

The new IP address information appears in the upper list in the dialog box, and the device's status changes to Mapped. The address information also appears in the lower list to show that this device has been mapped to this address.

Status changes to Mapped.

Address data appears in lower list.

Status	MAC Address	IP Address	Subnet Mask	Hostname	Gateway Addr...
Mapped	00-CC-3D-00-99-9C	10.199.54.190	255.255.199.0		0.0.0.0

MAC Address	IP Address	Subnet Mask	Hostname	Gateway Addr...	DNS Addr...
00-CC-3D-00-99-9C	10.199.54.190	255.255.199.0		0.0.0.0	0.0.0.0

8. With the device still highlighted, click Assign.

The status changes to IP Address Assigned.

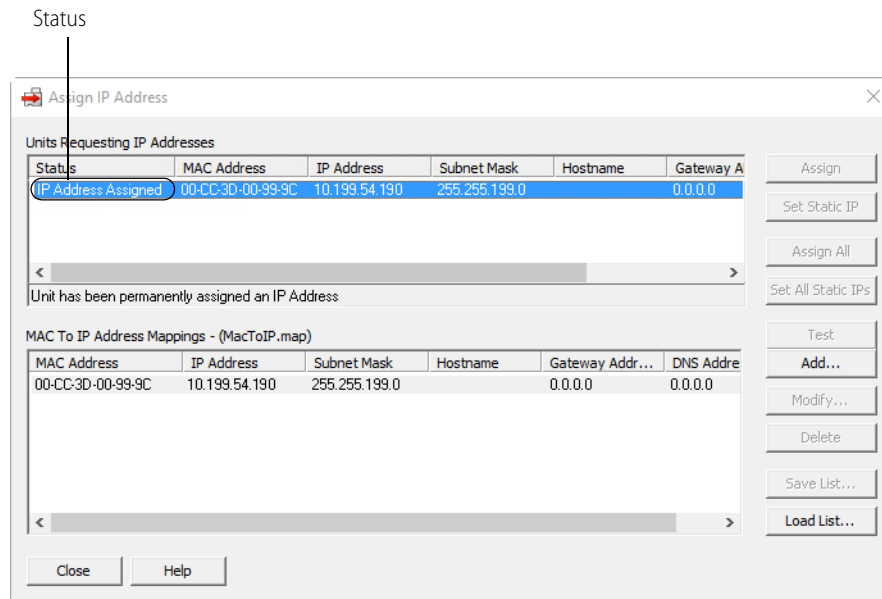

*NOTE: Once a device's status becomes Assigned, you can no longer change its IP address information from this dialog box. To change the address, use Tools > Change IP Settings. (See page 223.)*

9. Now click the Set Static IP button to store the static IP address.  
The address information is saved to flash memory and the status changes to Static IP.
10. To verify that the IP address has been successfully assigned, highlight the device in the upper list and click Test.  
A DOS window opens and the IP address is automatically contacted using the PING program. You should see a reply similar to the following:

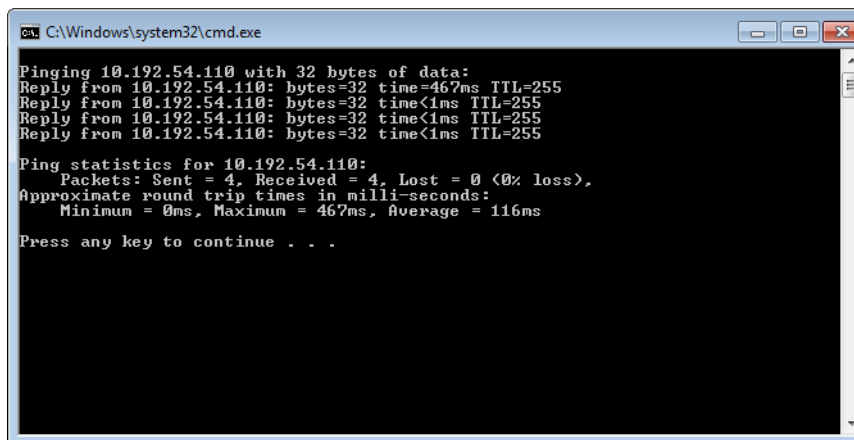

If you don't see a reply, make sure the subnet mask you've assigned matches the subnet mask on your PC.

11. For future reference, write the IP address in the white space on the brain board.  
The E1 or E2 brain board is now ready for use with a static IP address.
12. Repeat steps 5 through 11 for any other brain boards in the list that you are responsible for.

- To save for future reference the list of IP address and MAC address mappings (the lower list in the dialog box), click the Save List button. Navigate to the folder where you want to save the file, enter a filename, and click Save.

The address information is saved. You can load this information into PAC Manager later if you need to see it.

PAC-S  
PAC-R  
EB  
SB  
UJO  
EIO  
SIO  
E1  
E2

## Assigning IP Addresses to Multiple Devices

*NOTE: In order to assign IP addresses, you must be logged in with administrative rights.*

If you are an OEM, integrator, or customer who has a large number of Opto 22 devices to work with at once, you may find it easier to first create a file of MAC-to-IP address mappings, and then assign IP addresses from the file. This method works for SNAP Ethernet-based controllers, brains, and brain boards.

### Creating the Map File

- Make sure you have the MAC addresses for all Opto 22 devices in front of you. Also make sure you know what IP addresses and subnet masks you are going to use for them.

The MAC address for each device appears on a white sticker or space on the device itself. To determine the IP addresses and subnet masks to use, work with the network administrator for the Ethernet network on which the devices will be used.

*NOTE: On a SNAP PAC controller, you can assign only the primary IP address using these steps. To assign the secondary IP address (Ethernet 2), follow steps on [page 30](#).*

- Before installing the Opto 22 devices, open PAC Manager. (For instructions, see the footnote on [page 16](#).)
- From the Tools menu, click Assign IP Address.

The Assign IP Address dialog box opens.

Upper section is used for live assignment to devices.

Lower section shows contents of a file containing lists of addresses. These addresses may or may not be actual assignments.

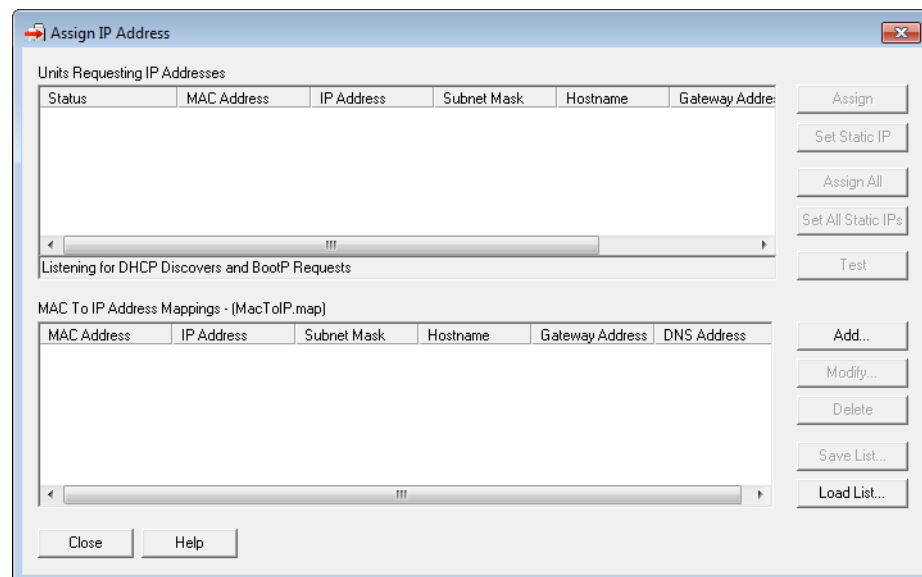

The **upper section** of this dialog box lists all Opto 22 devices on the same network that send a BootP or DHCP broadcast while the dialog box is open. When you are ready to assign IP addresses, this is where you do so. For now, ignore anything that appears here.

The **lower section** shows the contents of a mapping file you create, either while assigning actual addresses or in advance of assigning them. This file can be saved, changed, and reloaded at a later time for reference or to quickly assign addresses using the upper section—but the actual addresses on

## ASSIGNING AN IP ADDRESS

devices cannot be assigned or changed here. The important thing to remember about this lower section is that *the list does not necessarily reflect actual addresses on devices*. The IP addresses in the list may not have been assigned yet, or a device's address might have been changed at some point and the list not updated.

4. In the lower section of the dialog box, click Add.

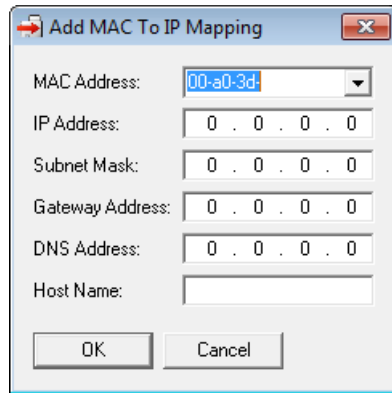

5. For the first Opto 22 device, type the correct MAC address (the first six digits are entered for you; they are the same for all Opto 22 devices). Enter the IP address and subnet mask. Enter the Gateway address if needed. Leave the DNS address at 0.0.0.0 and the Host Name field blank.
6. Double-check all numbers. When all are correct, click OK.  
The device's address information is listed in the lower section of the dialog box.

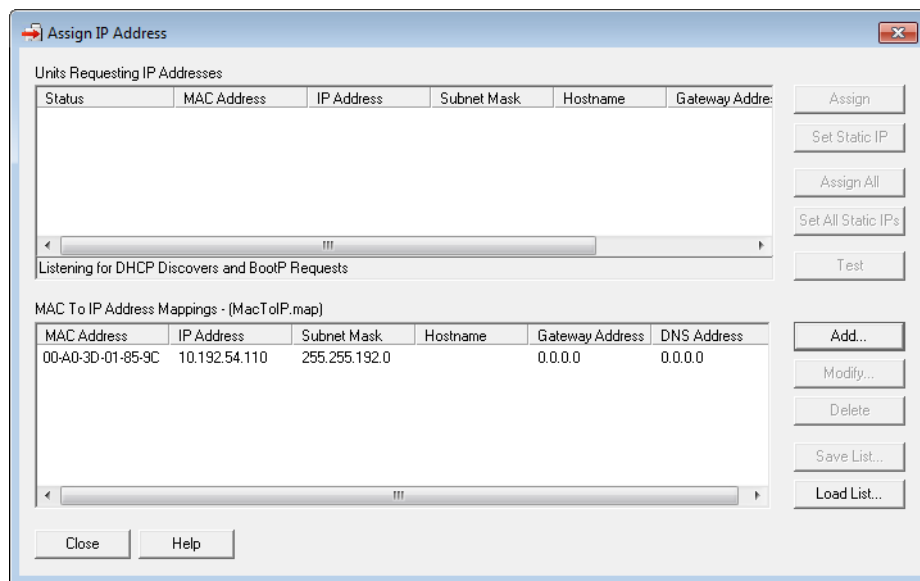

Status	MAC Address	IP Address	Subnet Mask	Hostname	Gateway Address

MAC Address	IP Address	Subnet Mask	Hostname	Gateway Address	DNS Address
00-A0-3D-01-85-9C	10.192.54.110	255.255.192.0		0.0.0.0	0.0.0.0

- Click Add again and add additional addresses until all of them are listed in the lower section.

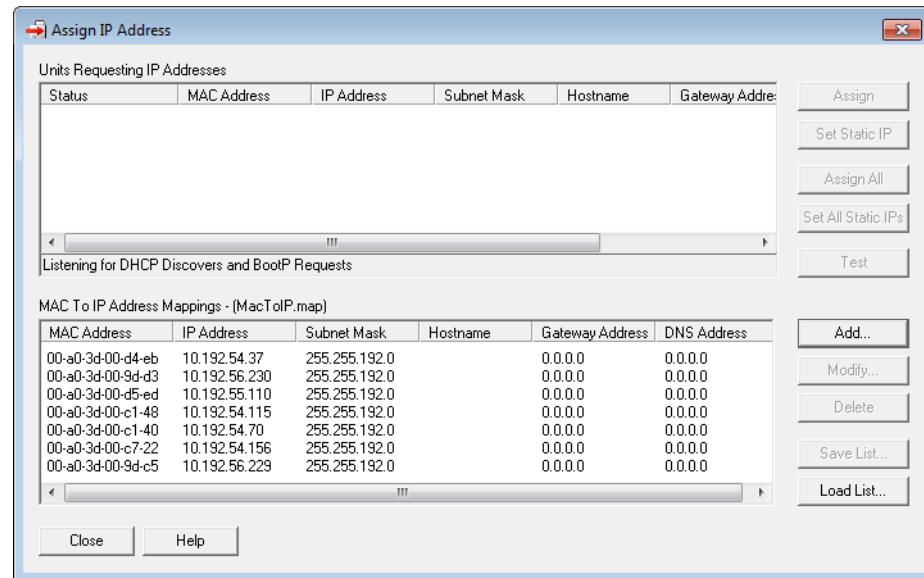

- Double-check the addresses. If one is incorrect, click it to highlight it, click Modify, and make the necessary changes.
- To save the mapping file, click Save List. In the Save dialog box, navigate to the folder where you want to place the file, enter a filename, and click Save.  
The .map file is saved as a simple text file. This allows it to be modified in text editors such as Notepad.
- Continue with the next section to assign the addresses.

PAC-S  
PAC-R  
EB  
UIO  
EIO  
SIO  
E1  
E2

#### Assigning Addresses from the Map File

*NOTE: BootP and DHCP broadcasts cannot get through a firewall in the computer where PAC Manager is running. Make sure any firewall in the computer is disabled before you try to assign IP addresses. Firewalls in a router should not be a problem.*

- IMPORTANT:** Disable all DHCP servers on the Ethernet network you are using to assign IP addresses.  
If a DHCP server is enabled on the network, it may assign IP addresses before PAC Manager has a chance to do so. If that happens, turn off power to the devices, disable all DHCP servers, and turn the devices back on. They should broadcast again.
- Make sure that each Opto 22 device is installed according to directions in its user's guide. Make sure the computer you use is on the same network segment as the devices.
- Turn on all the Opto 22 devices.
- If PAC Manager isn't already open, start it. (For instructions, see the footnote on [page 16](#).)
- In the PAC Manager menu bar, click Tools > Assign IP Address.
- If the .map file you want does not appear in the lower section of the Assign IP Address dialog box, click Load List, locate the file, and open it.

The Opto 22 devices begin to appear in the upper section of the dialog box. IP address information from the map file is copied to the corresponding MAC address in the upper section, and the status of each device changes to Mapped.

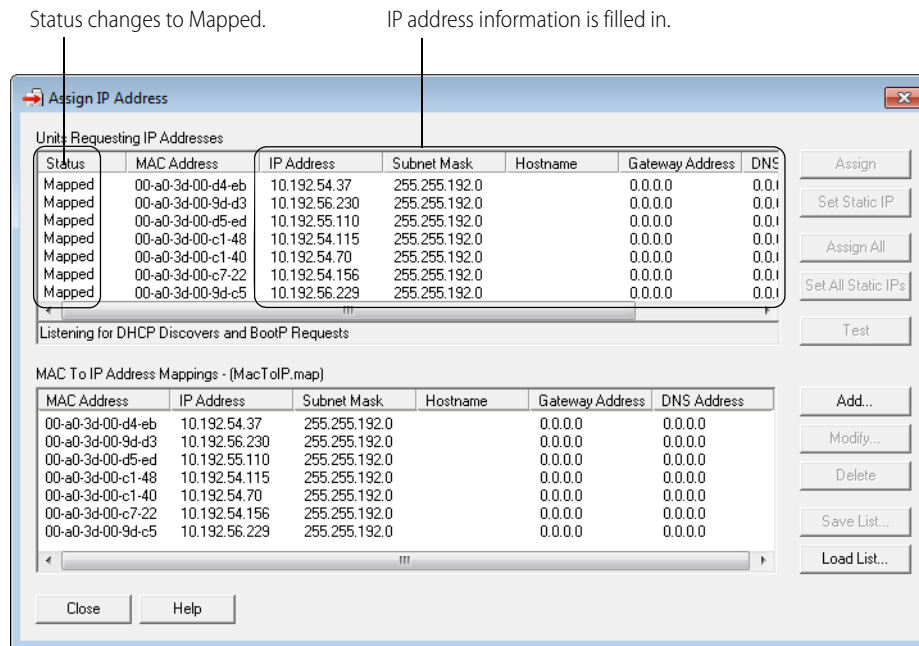

7. Check the address information. If anything is incorrect, double-click the device in the lower list and change it. Click Save List to save the change to the file. The change is automatically made to the upper section.
8. When all addresses are correct, click Assign All. The address is saved to flash memory, and the status changes to Static IP.
  - On DHCP devices, the status changes to Assigned.
  - On BootP devices, the address is saved to flash memory, and the status changes to Static IP.
9. If any E1s and E2s are in the list, click Set All Static IPs to save the IP address information as static addresses. If you do not save the address as a static IP address, the E1s and E2s will lose their addresses as soon as power is turned off. The next time power is turned on, the brain boards will send out a DHCP broadcast again.

The devices now have their IP addresses. If you need to change an address, use Tools > Change IP Settings (see page 223). To assign an IP address to Ethernet 2 on a SNAP PAC controller, see the steps in the next section.



### Assigning an IP Address to Ethernet 2 (SNAP PAC Controller Only)

*NOTE: This section does not apply to SNAP PAC brains; the two Ethernet network interfaces on a SNAP PAC brain have the same IP address.*

*For Wired+Wireless models, see page 35 to configure the wireless LAN interface.*

SNAP PAC R-series and S-series controllers have two independent Ethernet network interfaces, labeled on the top of the controller as Ethernet 1 and Ethernet 2. The controller sends its initial BootP request from Ethernet 1, and the IP address you assign to the controller is for this primary interface. To communicate through Ethernet 2, you must assign it a separate IP address following the steps below.



*IMPORTANT: The two Ethernet interfaces will work only if they are on separate IP subnets, so the control engine can clearly determine where to direct communication. (The subnet masks can be the same or different, but when you perform a logical AND on the IP address and subnet mask for each interface, the two results must be different.) For example:*

	Ethernet 1	Ethernet 2
IP Address:	192.168.0.12	10.0.0.5
Subnet Mask:	255.255.255.0	255.255.255.0

*NOTE: If you need to configure or modify settings for the network interface cards on your computer, you must be logged in with administrative rights.*

1. If PAC Manager isn't already open, start it. (For instructions, see the footnote on [page 16](#).)
2. In the PAC Manager main window, click the Inspect button . The Inspect window opens.
  - If you haven't used the Inspect window before, the window will not show any data.

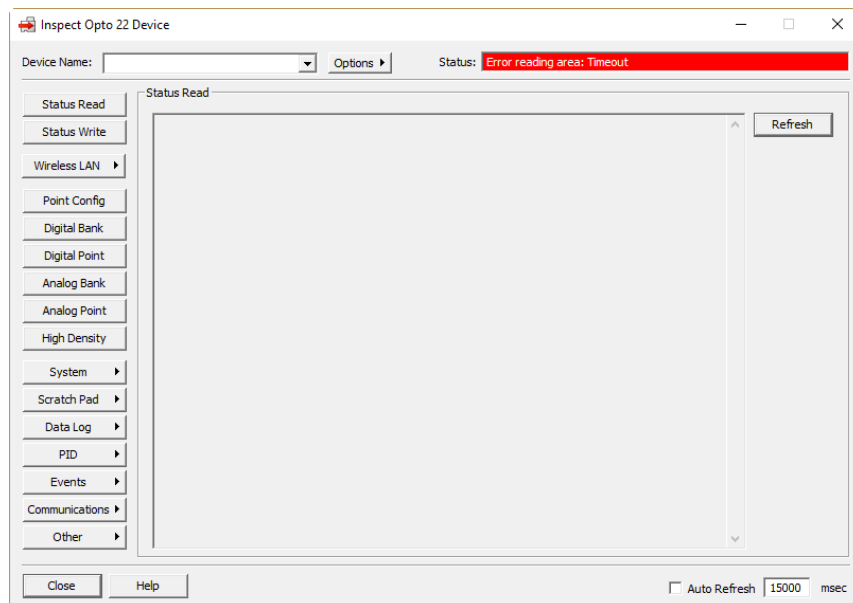

## ASSIGNING AN IP ADDRESS

- If you *have* used the Inspect window before, the last device you inspected is shown in the Device Name field, and current Status Read information appears in the window.

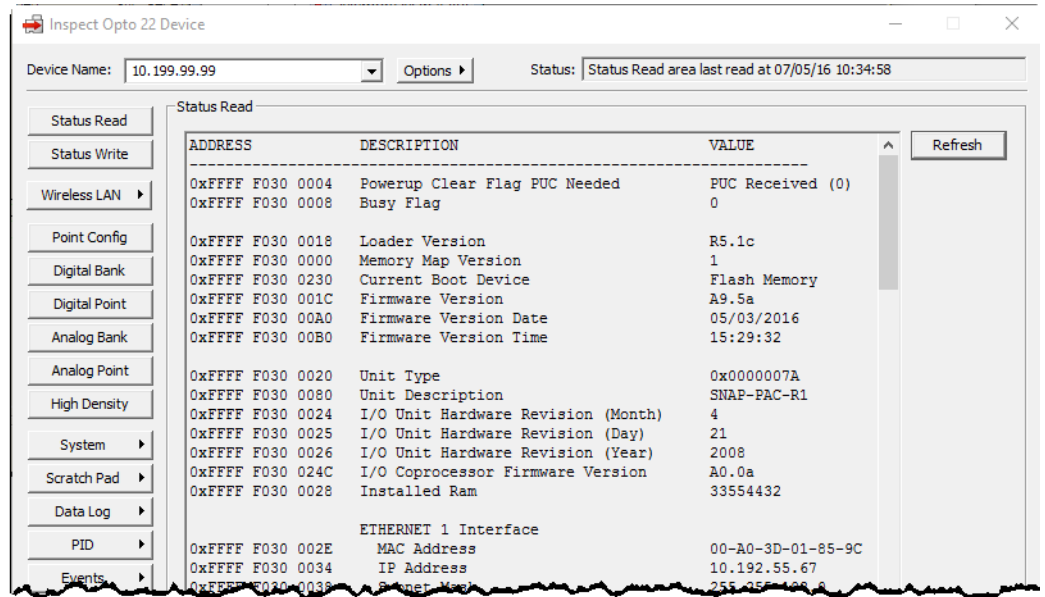

- If you have configured other devices, they are listed in alphabetical order in the drop-down list.
- If you have configured six or more devices, the Inspect window provides two additional features: Next and Back navigation buttons (to navigate back and forth through the alphabetized list of devices), and a list of the five most recently inspected devices (displayed at the top of the drop-down list).

Next and Back navigation buttons and Most Recently Used list are displayed when you have six or more devices configured.

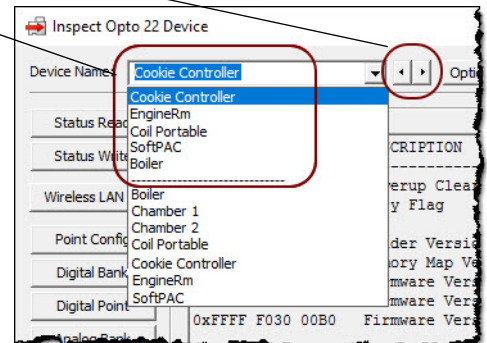

3. In the Device Name field, type the name for the SNAP PAC controller (or choose it from the drop-down list). If the controller has not been defined in PAC Manager, the Add New Device dialog box appears. Choose Direct Connection to Ethernet Device and enter the IP address of the primary Ethernet interface (Ethernet 1). Leave the Ethernet port at 2001 unless you have changed it on the controller.
4. Click Status Read.

Status information for the controller is shown in the window. Scroll down till you see ETHERNET 2 Interface. If the IP address for Ethernet 2 has not been assigned yet, the IP address information will show all zeros.

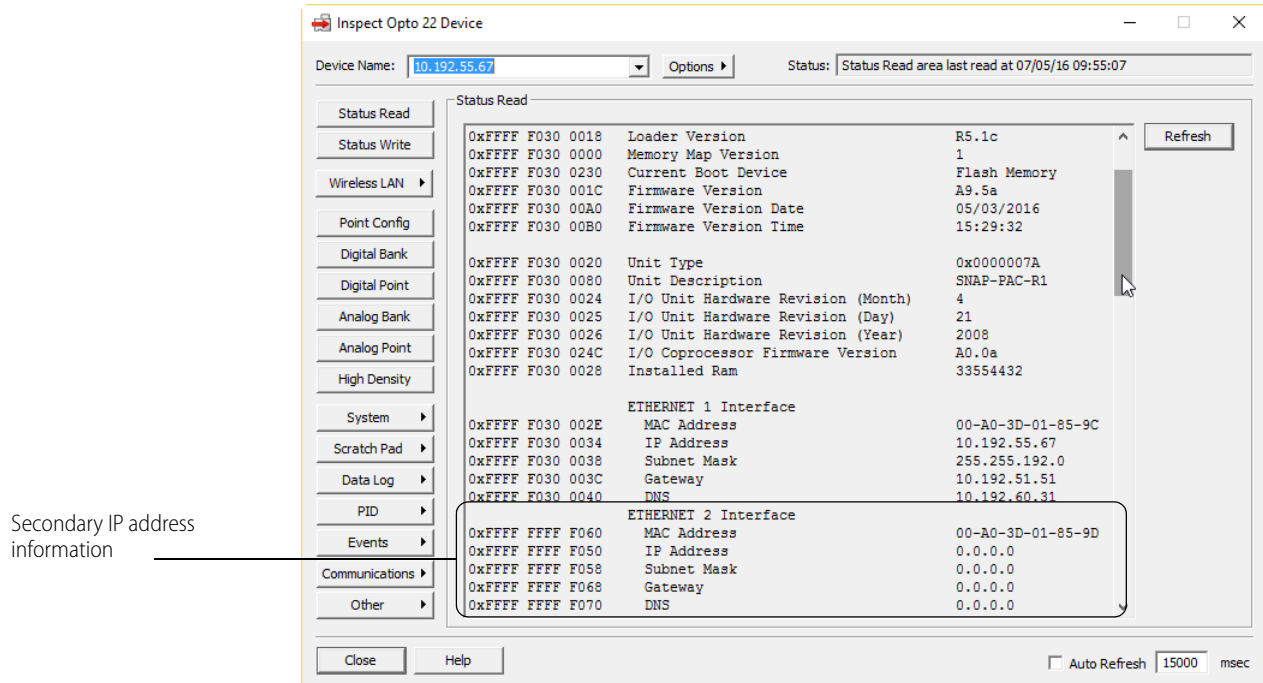

5. Click Status Write. Scroll down to see all the IP address fields for Ethernet 2.

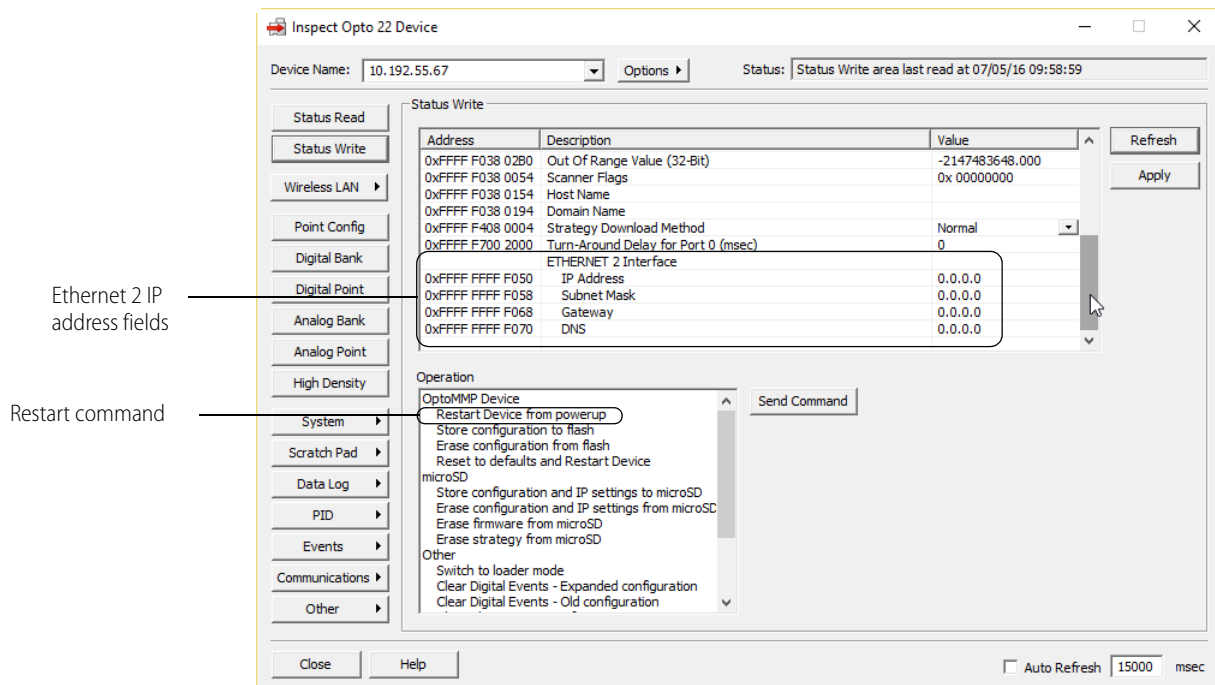

6. Click the Value field for IP Address under Ethernet 2 Interface and type in the IP address. Enter the Ethernet 2 Subnet Mask the same way. If necessary, change the Gateway. Leave the DNS as is.

## ASSIGNING AN IP ADDRESS

7. When all the secondary IP address fields are correct, click Apply.  
The information is sent to the SNAP PAC, but it cannot communicate on the Ethernet 2 interface until it is restarted.
8. In the Operation Commands section, highlight Restart Device from powerup. Then click Send Command.  
The SNAP PAC is restarted.
9. Check to make sure the controller is back on line by clicking Status Read again. Click OK at the message.  
Scroll down a little to see all the IP address information for Ethernet 2.

IP address for primary interface (Ethernet 1)

Ethernet 1 IP address information

Ethernet 2 IP address information

Address	Parameter	Value
0xFFFF F030 0000	Memory Map Version	1
0xFFFF F030 0230	Current Boot Device	Flash Memory
0xFFFF F030 001C	Firmware Version	A9.5a
0xFFFF F030 00A0	Firmware Version Date	05/03/2016
0xFFFF F030 00B0	Firmware Version Time	15:29:32
0xFFFF F030 0020	Unit Type	0x0000007A
0xFFFF F030 0080	Unit Description	SNAP-PAC-R1
0xFFFF F030 0024	I/O Unit Hardware Revision (Month)	4
0xFFFF F030 0025	I/O Unit Hardware Revision (Day)	21
0xFFFF F030 0026	I/O Unit Hardware Revision (Year)	2008
0xFFFF F030 024C	I/O Coprocessor Firmware Version	A0.0a
0xFFFF F030 0028	Installed Ram	33554432
<b>ETHERNET 1 Interface</b>		
0xFFFF F030 002E	MAC Address	00-A0-3D-01-85-9C
0xFFFF F030 0034	IP Address	10.192.55.67
	Subnet Mask	255.255.192.0
	Gateway	10.192.51.51
	DNS	10.192.60.31
<b>ETHERNET 2 Interface</b>		
0xFFFF FFFF F060	MAC Address	00-A0-3D-01-85-9D
0xFFFF FFFF F050	IP Address	10.10.10.7
0xFFFF FFFF F058	Subnet Mask	255.255.255.0
0xFFFF FFFF F068	Gateway	0.0.0.0
0xFFFF FFFF F070	DNS	0.0.0.0

10. To verify that the secondary IP address (Ethernet 2) is also communicating, make sure Ethernet 2 is attached to the correct network. On a computer on the same subnet as Ethernet 2, open the PAC Manager Inspect window. Enter the Ethernet 2 IP address (or a different name) in the Device Name field and click Status Read.  
The controller now shows the same information, but through the secondary interface:

IP address for secondary interface (Ethernet 2)

Ethernet 1 IP address information

Ethernet 2 IP address information

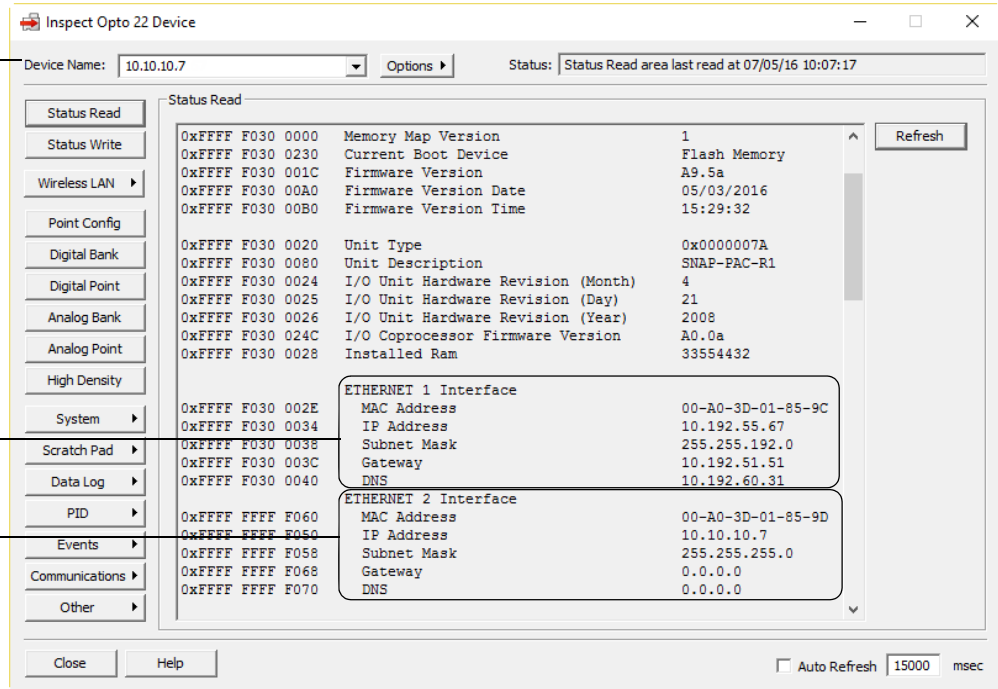

**PAC-S  
PAC-R  
EB**

### Configuring Wireless LAN Communication (Wired+Wireless Models Only)

This section applies only to SNAP PAC controllers and EB brains with wireless LAN interfaces (models ending in -W). These devices send their initial BootP request from Ethernet 1, and the IP address you assign to them is for this primary interface. To communicate through the wireless LAN interface, you must assign it a separate IP address and configure communication following the steps below.

*IMPORTANT: The wireless LAN interface will work only if it is on a separate IP subnet, so the device can clearly determine where to direct communication. (The subnet masks can be the same or different, but when you perform a logical AND on the IP address and subnet mask for each interface, the two results must be different.) For example, on a SNAP-PAC-S1-W you might use the following addresses and subnet masks:*

	Ethernet 1	Ethernet 2	Wireless LAN
IP Address:	11.192.55.162	10.10.10.7	146.87.12.250
Subnet Mask:	255.255.255.0	255.255.255.0	255.255.255.0

*NOTE: If you need to configure or modify the settings for the network interface cards on your computer, you must be logged in with administrative rights.*

1. If PAC Manager isn't already open, start it. (For instructions, see the footnote on [page 16](#).)
2. In the PAC Manager main window, click the Inspect button . The Inspect window opens.

## ASSIGNING AN IP ADDRESS

- If you haven't used the Inspect window before, the window will not show any data.

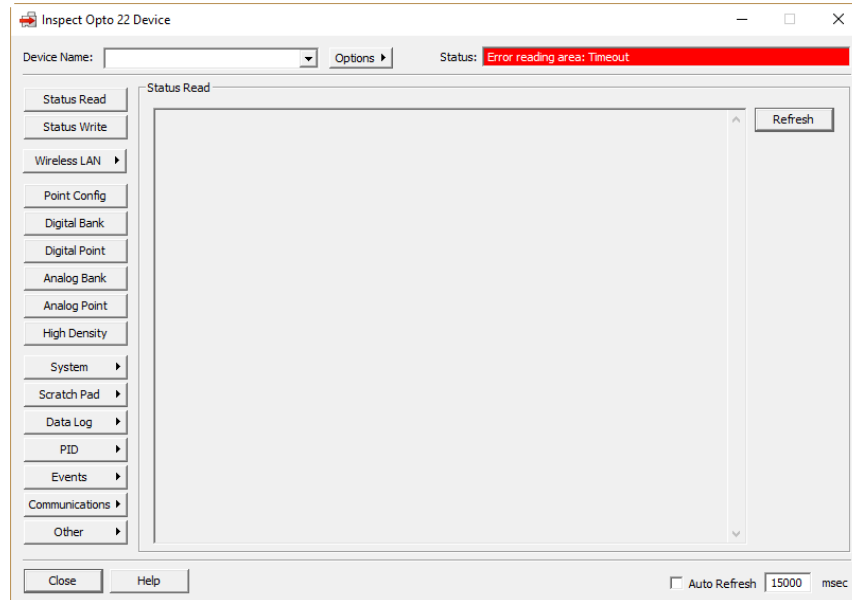

- If you *have* used the Inspect window before, the last device you inspected is shown in the Device Name field, and current Status Read information appears in the window.

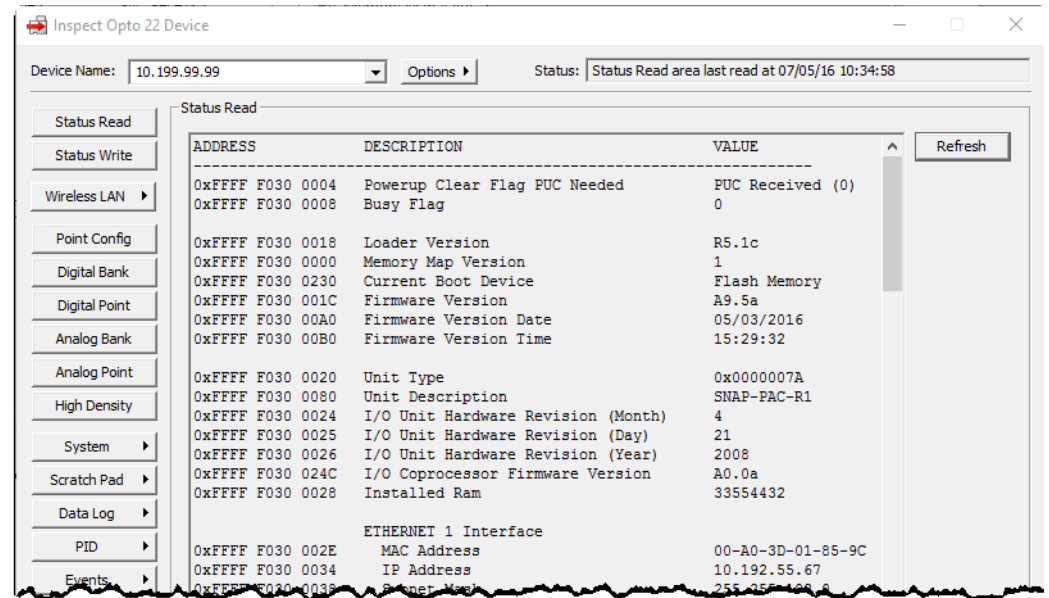

- If you have configured other devices, they are listed in alphabetical order in the drop-down list.
- If you have configured six or more devices, the Inspect window provides two additional time-saving features: Next and Back navigation buttons (to navigate back and forth through the alphabetized list)

of devices), and a list of the five most recently inspected devices (displayed at the top of the drop-down list).

Next and Back navigation buttons and Most Recently Used list are displayed when you have six or more devices configured.

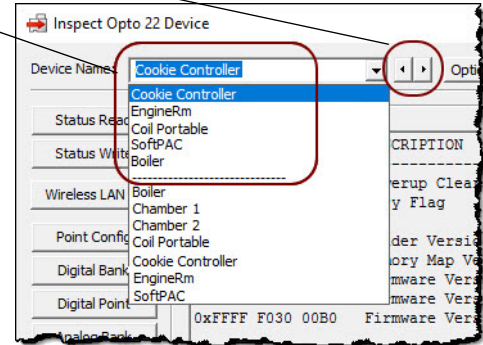

3. In the Device Name field, type the device's name or IP address (or choose it from the drop-down list).
4. Click Wireless LAN and choose Wireless LAN Configure from the popup menu.

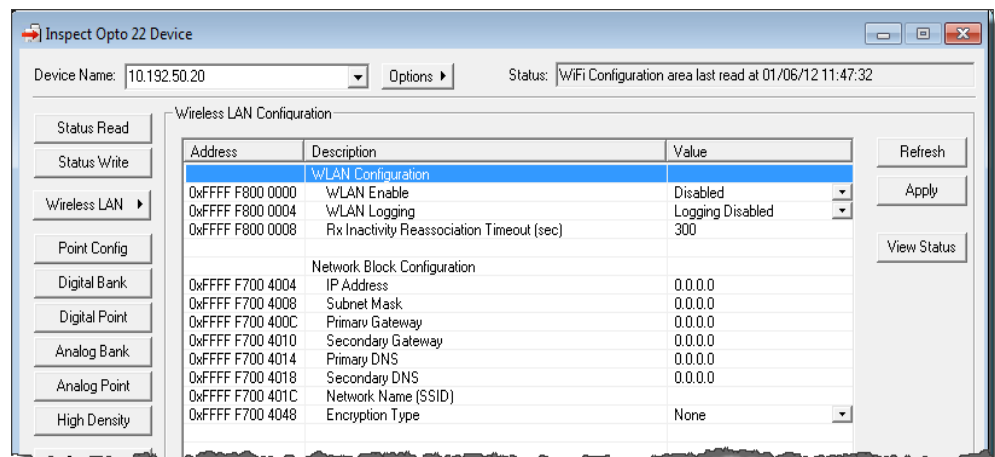

5. In the WLAN Enable line, click the arrow next to Disabled and choose Enable.
6. Leave WLAN Logging disabled and Rx Inactivity Timeout at the default of 300.
7. Under Network Block Configuration, enter the IP address and subnet mask for the wireless network. Remember that it must be on a separate network segment from the wired interfaces on the device.
8. If necessary, enter the Primary and Secondary Gateway addresses. Leave the Primary and Secondary DNS fields blank.
9. Type in the name of the wireless network (SSID).

- For Encryption Type, click the arrow next to None.

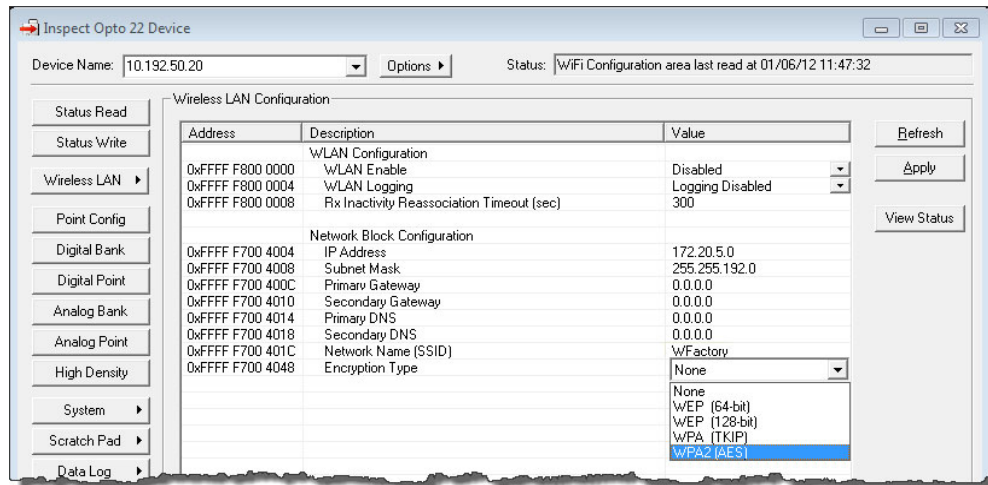

- From the drop-down list, choose the security used on the wireless network. Additional fields appear.
- Choose the Network Key Input Type, either Hexadecimal or ASCII (WEP is normally Hex; WPA and WPA2 are normally ASCII).
- Enter the Network Key (the password for the network). This field will show the password when you enter it; however, if you inspect the device later, the field will show only asterisks.
- When all fields are complete, click Apply.
- At the message asking whether you want to restart the device, click Yes. The configuration information is sent to the device and stored to flash memory, and the device is restarted. The WLAN LED turns orange to indicate that the interface is searching for or authenticating the wireless network. Once the network is found, the LED turns solid green.



16. To see connection status and signal strength, click the View Status button. (You can also see this screen by clicking Wireless LAN > Wireless LAN Status.)

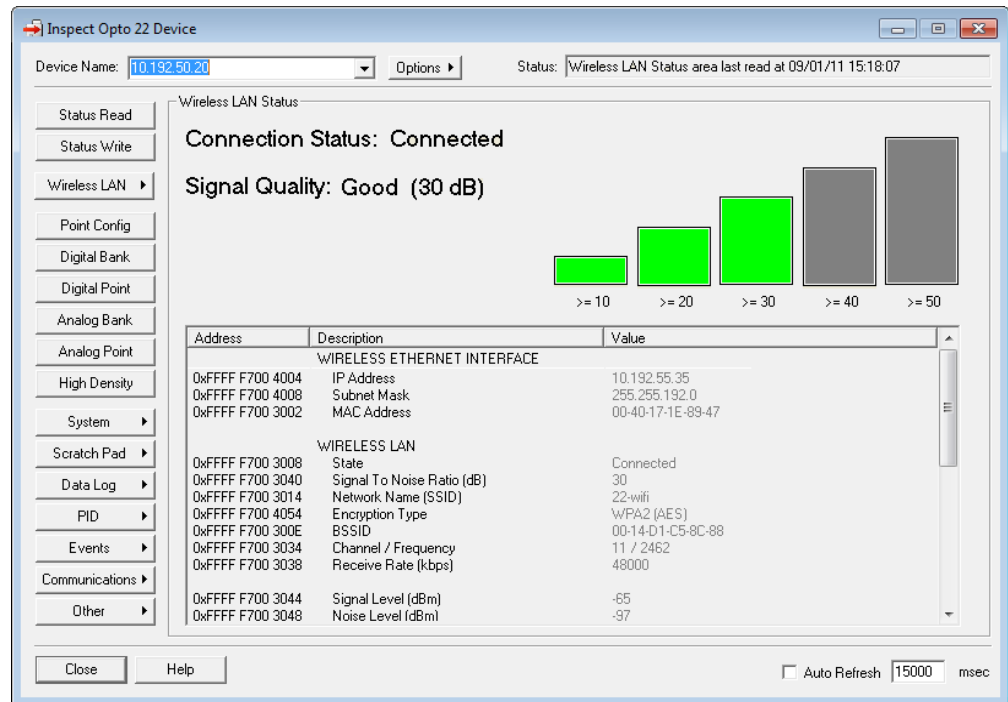

## CONNECTING WITH A SNAP PAC SB BRAIN

### SB

Most devices you communicate with using PAC Manager are Ethernet-based. That is, they have at least one Ethernet network interface and can be reached directly over an Ethernet network that includes the computer where PAC Manager is installed.

SNAP PAC **SB** brains are an exception: they have no Ethernet interface and instead communicate over a serial network. PAC Manager can communicate with SB brains in two ways, however.

- Through a SNAP PAC controller, via an Ethernet connection to the controller and then a serial connection from the controller to the brain. This method is easy and does not require the brain to be located near the computer.
- Directly from the computer to the brain, using the computer's serial port via a serial cable and an RS-485 adapter, such as an Opto 22 PCI-AC48 adapter card. This method is useful for configuring points and features before brains are deployed to the field, or if you are not using a SNAP PAC controller.

For connections, see wiring instructions in the [SNAP PAC Brains User's Guide](#) (form 1690).

## CREATING AN I/O UNIT CONFIGURATION FILE

*About E1 and E2 brain boards: You can configure E1s and E2s like any other I/O unit if you have E1/E2 firmware R1.2a (and higher) and PAC Project 9.5000 (and higher). Also, if a SNAP PAC controller communicates with the E1 or E2, the controller must have PAC firmware R9.5a (or higher) to use this simplified configuration method. If you are not using these firmware and software versions (or if you prefer to use the previous method to reconfigure existing E1s or E2s), see [I/O Configuration for E1 and E2 Brain Boards](#) (form 1576).*

*NOTE: This section applies to Ethernet-based I/O units and serial SNAP PAC SB brains, but not to serial mistic I/O units. mistic I/O units must be configured in PAC Control.*

PAC-R  
EB  
SB  
UIO  
EIO  
SIO  
E1  
E2

Before you create a control strategy using PAC Control, or before you read or write to I/O units, you need to configure the I/O points and features the strategy or other application will use. You can use PAC Manager to copy a configuration or to configure all points, save the configuration to a file, and then upload the configuration to one I/O unit or to several at once. You do not need to be attached to the I/O unit while you are creating the configuration file and configuring its points.

*NOTE: If you are using OPC to communicate with the I/O unit, you can use the configuration file (tag file) that PAC Manager produces as an easy way to reference points for OPC. For details, see the OptoOPCServer User's Guide (form 1439, available with the purchase of PAC Project Professional or OptoOPCServer).*

You can start configuration in one of three ways:

- If this is a new configuration, you can create a new configuration file (page 40).
- If an existing I/O unit has the exact configuration you want, you can copy it directly to another I/O unit (page 42).
- If you have a PAC Control (or OptoControl or ioControl) strategy with similar I/O units configured, you can save them as a configuration file (page 44) and modify the configuration. Note that this method transfers I/O unit and point information only; any event messages, email or SNMP settings, and so on are not included when a configuration file is exported from or imported to OptoControl, ioControl, or PAC Control. Also, 4-channel digital module and point information is generic; you will need to reenter specific digital configurations.

### Creating a New Configuration File

PAC-R  
EB  
SB  
UIO  
EIO  
SIO  
E1  
E2

1. If PAC Manager isn't already open, start it. (For instructions, see the footnote on page 16.)
2. In the PAC Manager main window, click the New button  or click File > New.
3. In the Create New Tag Database dialog box, navigate to the location where you want the file to be. Type a filename. Click Open.

A new configuration tree appears. (If you are familiar with PAC Control, ioControl, or OptoControl, you'll notice that this window looks like part of a Strategy Tree.)

Configuration tree

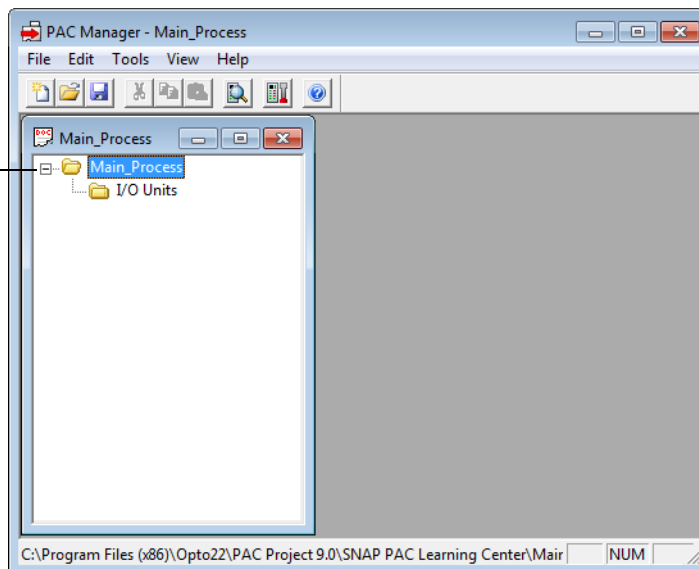

You can expand and collapse the folders to see or hide the I/O units and points in them. Closing the configuration tree is the same as closing the configuration file.

4. To save the configuration file, click the Save button  (or in the menu bar, click File > Save).
5. Once the file is saved, continue with [“Adding an I/O Unit” on page 44](#).

PAC-R  
EB  
SB  
UIO  
EIO  
SIO  
E1  
E2

### Copying an I/O Unit Configuration

If you have an I/O unit or a previously saved I/O unit image file with exactly the configuration you want to use, you can copy the configuration information to another I/O unit or to an I/O unit image file. This works with all SNAP PAC Ethernet and serial brains.

1. In the PAC Manager menu bar, click Tools > Import/Copy I/O Unit.

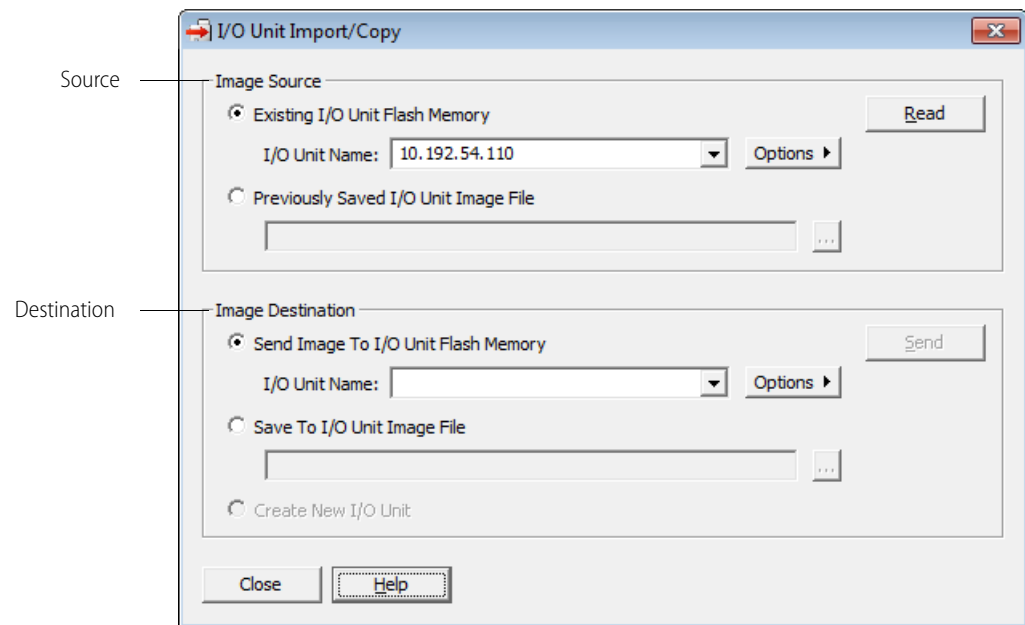

2. For the source, choose one of the following:
  - *Existing I/O Unit Flash Memory*: Choose an existing I/O unit. If you want to add or modify an I/O unit, click Options. For help, see [“Add/Modify New Device” on page 265](#).
  - *Previously Saved I/O Unit Image File*: Enter the name of the I/O image file you want to use, or click the browse button to find the file.

3. When the source is correct, click Read.

A success message appears when the data has been read. Click OK.

4. For the destination, choose one of the following:

*Send Image To I/O Unit Flash Memory*. Choose an existing I/O unit. If you want to add or modify an I/O unit, click Options. For help, see [“Add/Modify New Device” on page 265](#).

*Make sure you have entered the correct IP address. The configuration will overwrite anything currently in the I/O unit's flash memory.*

*Save To I/O Unit Image File*. Enter the name of the I/O image file you want to write to, or click the browse button to find the file.

*Create New I/O Unit*: Select this option to copy all the point information from a brain to create a new I/O unit in PAC Manager. You will be prompted to enter an I/O unit name. For more information, see [“Creating a New I/O Unit from an Existing One” on page 42](#).

## CREATING AN I/O UNIT CONFIGURATION FILE

5. When the destination is correct, click Send, Save, or Create depending on the destination type.  
A success message appears when the operation has completed.

### Creating a New I/O Unit from an Existing One

The Create New I/O Unit option on the I/O Unit Import/Copy dialog box allows you to create a new I/O unit by importing point information from the flash memory of an existing I/O unit directly into the tree structure of a configuration file (also known as a tag database). You can then configure, add, or delete points in the new I/O unit just as you would with an I/O unit created from scratch.

1. Make sure to save the existing I/O unit's configuration information to flash memory. See ["Saving Configuration to a Device's Flash Memory"](#) on page 212.
2. Open an existing configuration file on the File menu, or create a new one. For information, see ["Creating a New Configuration File"](#) on page 40.
3. In the PAC Manager menu bar, click Tools > Import/Copy I/O Unit.
4. For the Image Source, choose Existing I/O Unit Flash Memory.
5. Enter the IP address of the existing I/O unit, and click Read.  
A success message appears when the data has been read. Click OK.
6. For the destination, choose Create New I/O Unit, and click Create.

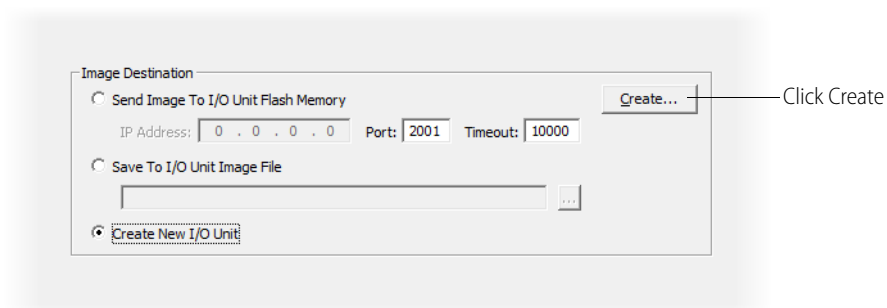

7. In the Add I/O Unit dialog box that appears, enter a name for the new I/O unit, and click OK.  
The new I/O unit is added to the open tag database and a success message appears. Click OK.
8. Close the I/O Unit Import/Copy dialog box.
9. Expand the new I/O unit to see the imported points.

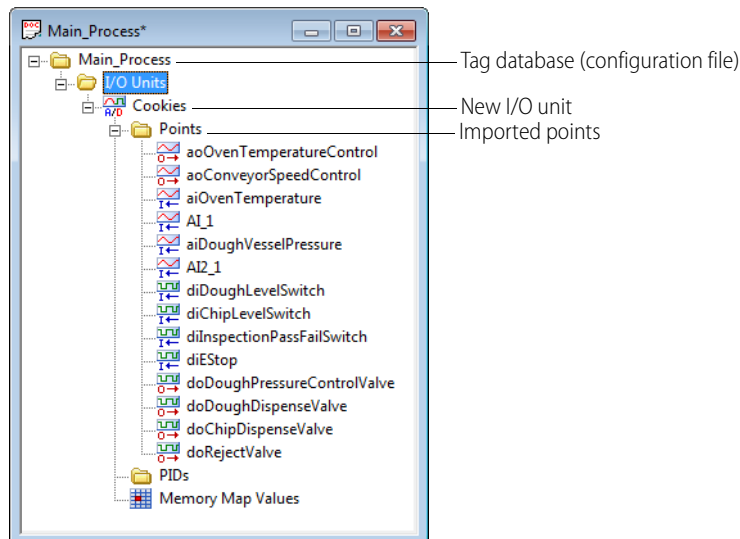

10. Before you can save the new I/O unit, the digital points must be assigned specific modules as follows:
  - a. Right-click a digital point and select Configure from the popup menu.
  - b. Double-click a generic digital module.

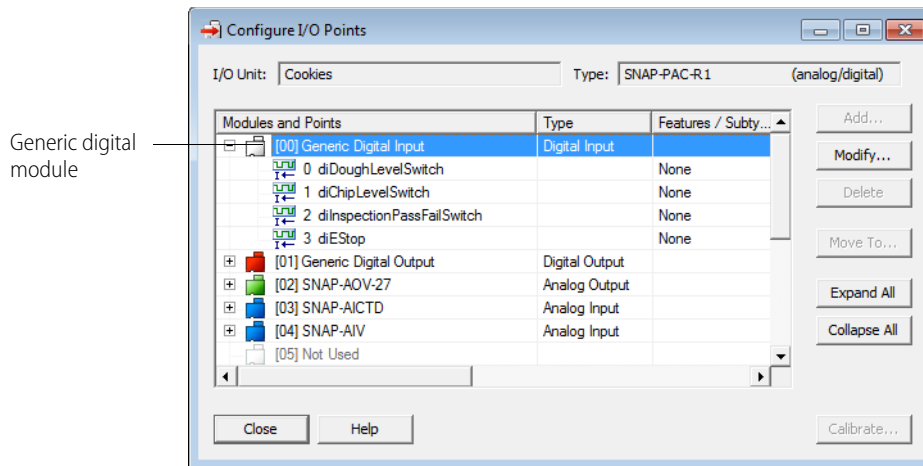

- c. In the Edit Module dialog box, select a digital module to match the existing I/O unit, and then click OK.

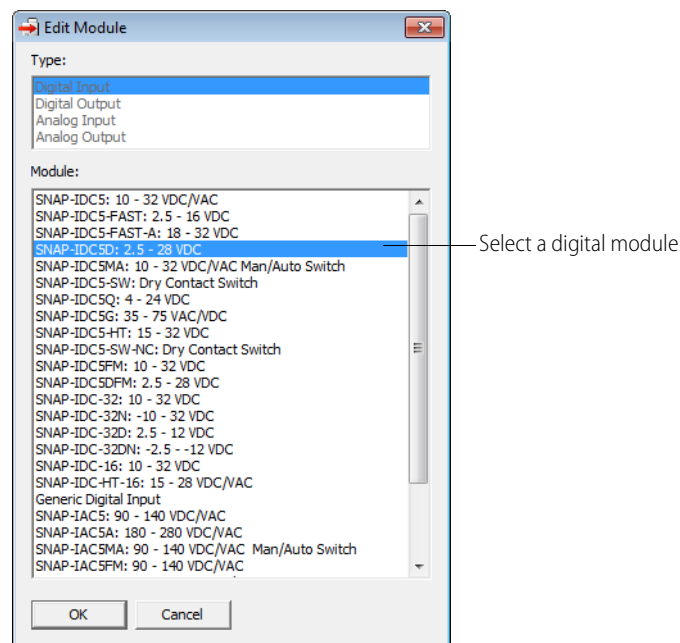

- d. Repeat steps **b** and **c** for each generic module on the new I/O unit.
  - e. Close the Configure I/O Points dialog box.
11. Save the new I/O unit.

PAC-R  
EB  
SB  
UIO  
EIO  
SIO  
E1  
E2

### Creating a Configuration File from Another Strategy

If you use PAC Control, ioControl, or OptoControl and have a strategy with SNAP PAC I/O units already configured, you may want to export that file and use it as a starting point, rather than creating a configuration file from scratch. The exported file will contain all the I/O units in the strategy. However, note the following:

- I/O unit and point data is transferred; optional functions such as event messages are not.
- Four-channel digital modules and points do not retain specific configurations but revert to generic ones. Specific data will have to be reentered.
- You cannot save changes you make in PAC Manager back to the strategy file. Instead, you save them to a configuration file, which can then be imported into PAC Control or OptoControl.
- Any *mistic* serial I/O units in the PAC Control, ioControl, or OptoControl strategy file are filtered out in PAC Manager and are no longer included in the configuration file. SB serial I/O units are included, however.

Follow these steps to create a configuration file from an existing strategy:

1. In PAC Control, ioControl, or OptoControl, open the strategy that contains the I/O units whose configurations you want to export.
2. In the configuration tree, right-click the I/O Units folder and choose Export from the pop-up menu.
3. In the Export I/O Units to an Opto Tag Database dialog box, navigate to the location where you want to save the configuration file. Enter a name for the file, and click Save.
4. If PAC Manager isn't already open, start it. (For instructions, see the footnote on [page 16](#).)
5. In the PAC Manager main window, click the Open button  or click File > Open.
6. In the Open Tag Database dialog box, locate the file you just saved and open it.

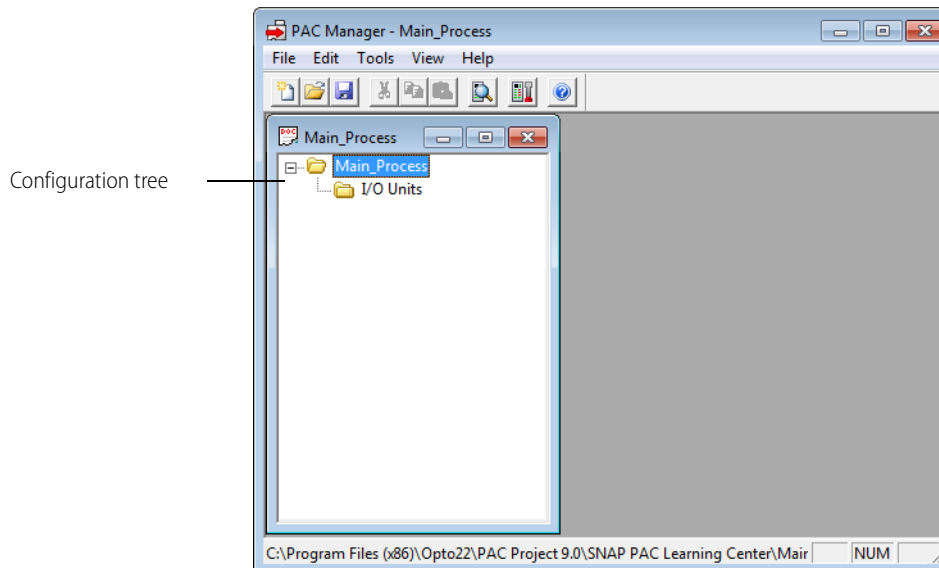

7. Expand the I/O Units folder in the configuration tree to see the units and points that are already configured.
8. Continue with the next section to add or change I/O units.

### ADDING AN I/O UNIT

*About E1 and E2 brain boards: You can configure E1s and E2s like any other I/O unit if you have E1/E2 firmware R1.2a (and higher) and PAC Project 9.5000 (and higher). Also, if a SNAP PAC controller communicates with the E1 or E2, the controller must have PAC firmware R9.5a (or higher) to use this simplified configuration method. If you are not using*

these firmware and software versions (or if you prefer to use the previous method to reconfigure existing E1s or E2s), see [I/O Configuration for E1 and E2 Brain Boards \(form 1576\)](#).

**PAC-R**  
**EB**  
**SB**  
**UIO**  
**EIO**  
**SIO**  
**E1**  
**E2**

*NOTE: mistic serial I/O units used with a SNAP PAC S-series controller must be configured in PAC Control.*

An I/O unit consists of a SNAP I/O mounting rack, plus the I/O processor (brain or on-the-rack controller) and I/O modules mounted on it. Racks used with SNAP PAC Ethernet-based and SB I/O units can hold up to 16 modules. The types of modules and number of points on them depend on the I/O processor model and type of rack.

You must add an I/O unit before you can configure its modules and points.

1. Make sure the configuration file is open. On the configuration tree, double-click the I/O Units folder to open the Configure I/O Units dialog box:

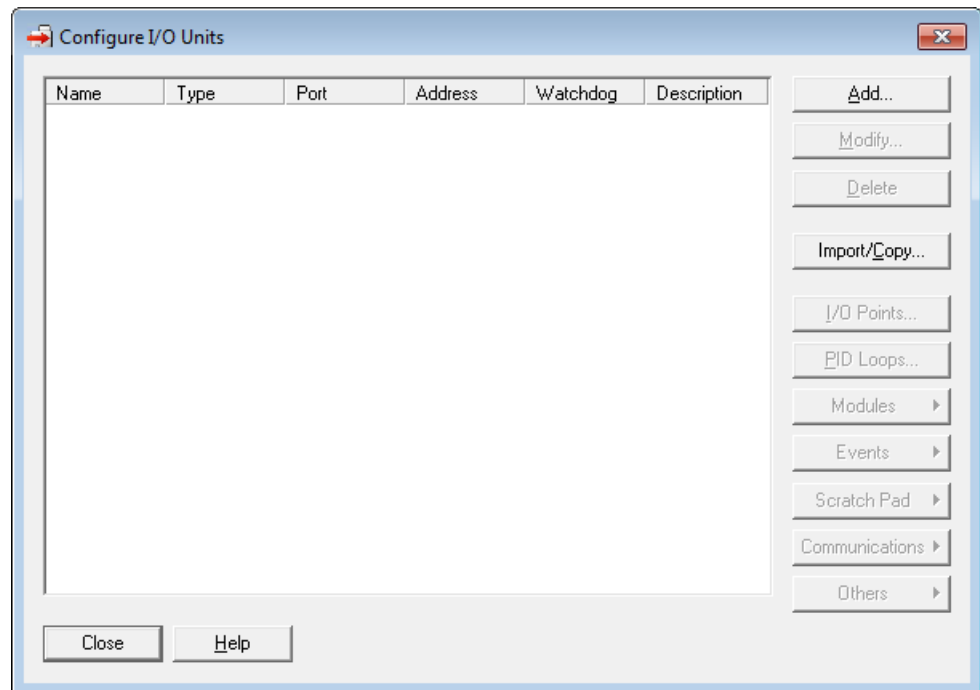

2. To configure a new I/O unit, click Add or double-click anywhere in the box below any listed units. The Add I/O Unit dialog box appears.

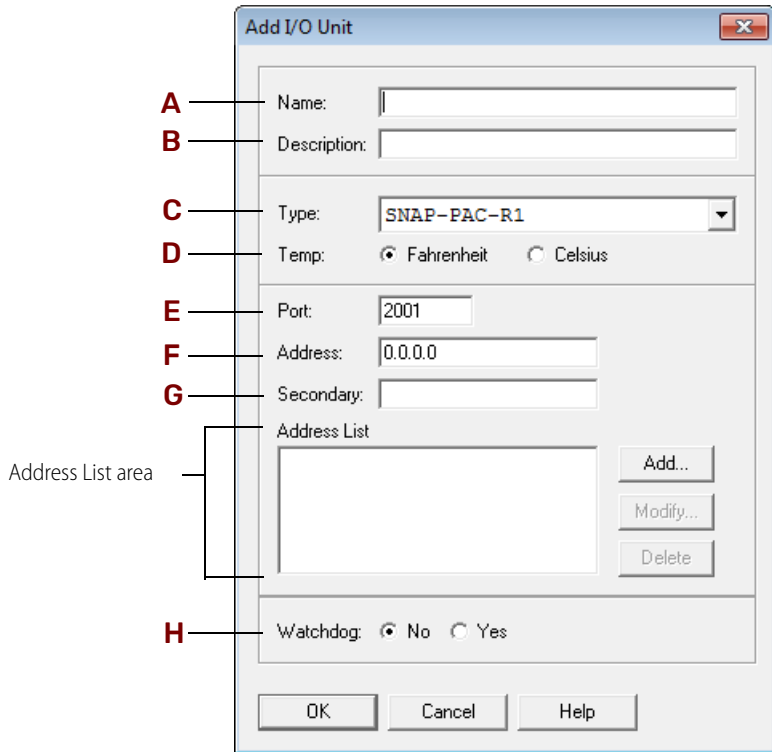

3. For a SNAP PAC SB brain, skip to [step 5](#). For an **Ethernet-based unit**, complete the fields as follows:

**A—Name.** Enter a name for the I/O unit. The name must start with a letter and may contain letters, numbers, and underscores. Spaces are converted to underscores.

**B—Description.** (Optional) Enter a description of the unit.

**C—Type.** Select the type of I/O unit from the drop-down list.

**D—Temp.** Choose whether temperatures will be handled in Fahrenheit or Celsius.

**E—Port.** Specify the communication port to use (2001, unless you have changed it for security purposes according to instructions starting on [page 94](#)).

**F—Address.** Enter the IP address for the I/O unit.

**G—Secondary.** If it's a SNAP PAC R-series I/O unit with a secondary IP address, enter the secondary IP address.

**H—Watchdog.** Select whether you want a Watchdog on the unit. The default is No (disabled). If you select Yes, a new field appears; enter the Watchdog timeout value in seconds. The default timeout is 0.5 seconds. For information on watchdogs, see [page 88](#).

4. The *Address List area* shows IP addresses of the I/O units that should receive this configuration. If this is the only I/O unit to receive the configuration, don't add any addresses here. However, if you have I/O units that are exactly alike, list all of them here. That way you can download the configuration file to all the I/O units at once.

a. To add an IP address, click Add.



In the dialog box, you can add a single IP address or a range of addresses.

- b. Enter the IP address(es) and click OK.  
The addresses appear in the Address List area.
  - c. Skip to [step 6](#).
5. For a SNAP PAC **SB brain**, complete the dialog box as follows:

**A—Name.** Enter a name for the I/O unit. The name must start with a letter and may contain letters, numbers, and underscores. Spaces are converted to underscores.

**B—Description.** (Optional) Enter a description of the unit.

**C—Type.** Select the type of I/O unit from the drop-down list.

**D—Temp.** Choose whether temperatures will be handled in Fahrenheit or Celsius.

**E—Connection.** Choose whether you are connecting to the SB brain through a SNAP PAC controller or directly from the computer (for more information, see [“Connecting with a SNAP PAC SB Brain” on page 39](#)).

**F—Ethernet Passthrough.**

- Enter the controller’s IP address. Leave the port at 2001 unless you have changed it.
- Enter the controller’s serial port where the brain is connected. On a SNAP-PAC-S1, it’s Serial 2. On a SNAP-PAC-S2, it could be any port.
- The baud rate on the controller must match the rate set on the brain.
- Enter the serial address of the brain.

**G—Serial Direct.**

- Enter the serial port on the computer where the brain is connected. The baud rate on the controller must match the rate set on the brain.
- Enter the serial address of the brain.

**H—Watchdog.** Select whether you want a Watchdog on the unit. The default is No (disabled). If you select Yes, a new field appears; enter the Watchdog timeout value in seconds. The default timeout is 0.5 seconds. For information on watchdogs, see [page 88](#).

6. When information in the Add I/O Unit dialog box is complete, click OK.  
The new I/O unit appears in the Configure I/O Units dialog box.

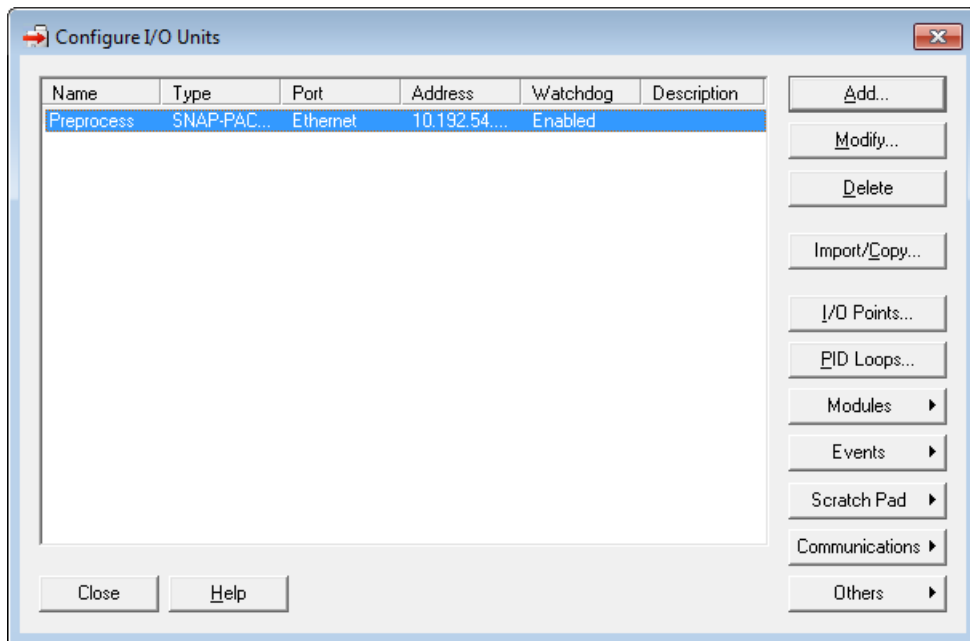

7. Continue with the next section, [“Configuring I/O Modules and Points.”](#)

## CONFIGURING I/O MODULES AND POINTS

*About E1 and E2 brain boards: You can configure E1s and E2s like any other I/O unit if you have E1/E2 firmware R1.2a (and higher) and PAC Project 9.5000 (and higher). Also, if a SNAP PAC controller communicates with the E1 or E2, the*

controller must have PAC firmware R9.5a (or higher) to use this simplified configuration method. If you are not using these firmware and software versions (or if you prefer to use the previous method to reconfigure existing E1s or E2s), see [I/O Configuration for E1 an E2 Brain Boards](#) (form 1576).

PAC-R  
EB  
SB  
UIO  
EIO  
SIO  
E1  
E2

*NOTE: I/O points on mistic serial I/O units must be configured in PAC Control. SNAP PAC SB I/O units can be configured in either PAC Manager or PAC Control.*

Once you have added an I/O unit, you can configure its modules and points. See the following pages for configuration steps. For motion control modules (such as SNAP-SCM-MCH16), see the [SNAP PAC Motion Control User's Guide](#) (form 1673).

## Configuring SNAP Digital Points

PAC-R  
EB  
SB  
UIO  
EIO  
SIO  
E1

*About E1 and E2 brain boards: You can configure E1s and E2s like any other I/O unit if you have E1/E2 firmware R1.2a (and higher) and PAC Project 9.5000 (and higher). Also, if a SNAP PAC controller communicates with the E1 or E2, the controller must have PAC firmware R9.5a (or higher) to use this simplified configuration method. If you are not using these firmware and software versions (or if you prefer to use the previous method to reconfigure existing E1s or E2s), see [I/O Configuration for E1 an E2 Brain Boards](#) (form 1576).*

*NOTE: I/O points on mistic serial I/O units must be configured in PAC Control. SNAP PAC SB I/O units can be configured in either PAC Manager or PAC Control.*

*For G4 or Quad Pak digital points on a G4EB2, see .*

Use the following steps to configure digital points on all digital modules supported by the brain or on-the-rack controller.

1. In the Configure I/O Units dialog box, make sure the I/O unit for the point you are adding is highlighted. Click the I/O Points button.

The Configure I/O Points dialog box appears. The dialog box shown here is for a SNAP I/O unit.

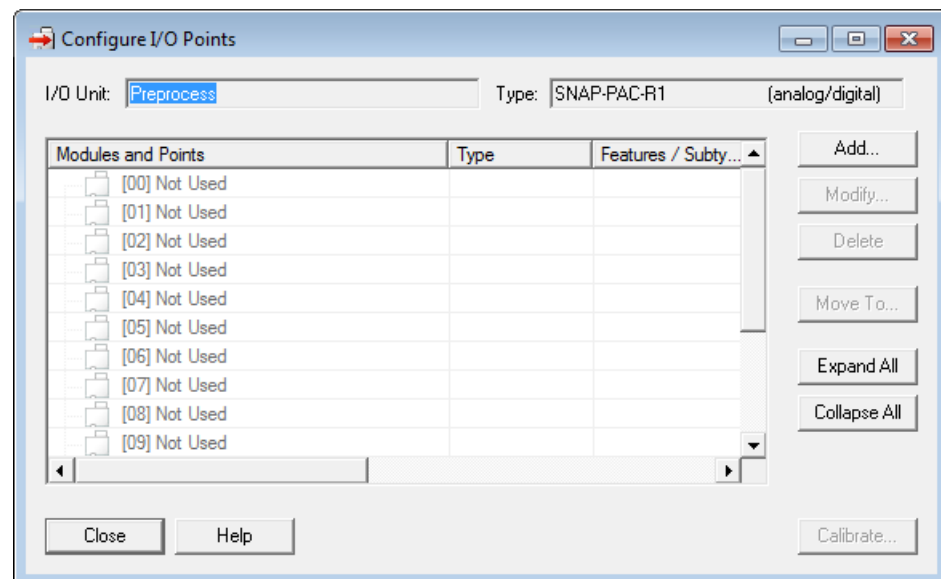

2. Double-click the number that represents the digital module's position on the rack. (For help, see the diagrams starting on [page 173](#).)

- For a SNAP I/O unit, choose the module type and then the exact module part number from the list.

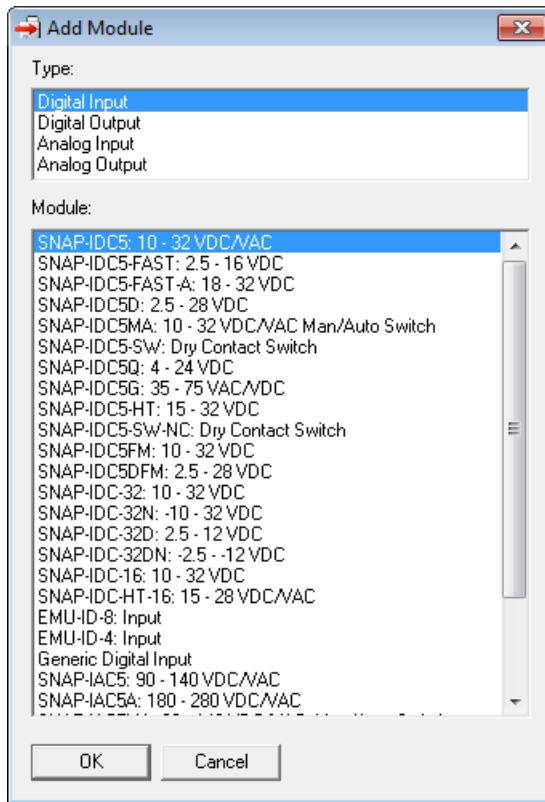

- Click OK.
- Back in the Configure I/O Points dialog box, click the plus sign next to the new module to expand it. Notice that the module icon is color-coded to reflect the type of module being configured: white for digital DC input, red for digital DC output, yellow for digital AC input, and black for digital AC output.

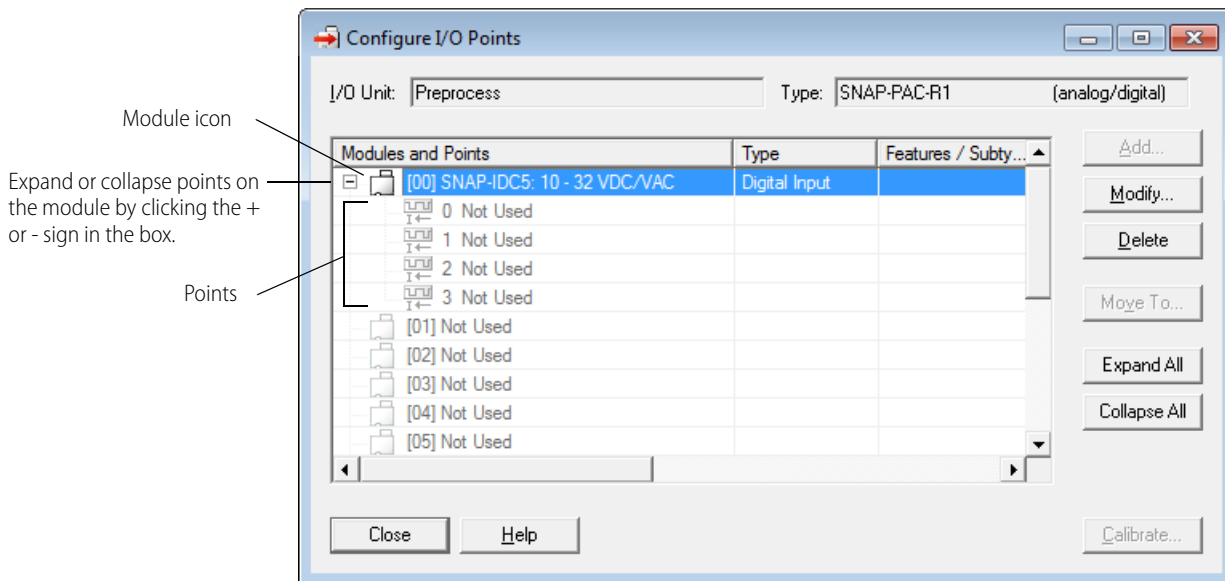

- Double-click the point you want to configure.

The screenshot shows the 'Add Digital Point' dialog box with the following fields and callouts:

- A**: Points to the **Name** text input field.
- B**: Points to the **Description** text input field.
- C**: Points to the **Type** dropdown menu, which is currently set to 'Input'.
- D**: Points to the **Module** dropdown menu, which is currently set to 'SNAP-IDC5: 10 - 32 VDC/VAC'.
- E**: Points to the **Watchdog** section, which includes radio buttons for 'No' (selected) and 'Yes'.

At the bottom of the dialog box are three buttons: **OK**, **Cancel**, and **Help**.

- Complete the fields as follows:

**A—Name.** Enter a name for the point. The name must start with a letter and may contain letters, numbers, and underscores. Spaces are converted to underscores.

**B—Description.** (Optional) Enter a description of the point.

**C—Type, Module.** For a SNAP I/O unit, the type and module are already filled in for you.

**D—Features.** To use a feature of the module, choose it from the drop-down list. (See [“Using I/O Point Features” on page 85](#) for explanations of point features. Note that some features, such as pulsing and totaling, can be configured in PAC Manager but require PAC Control to use them.)

**E—Watchdog.** (Output modules only) To configure a status the point should be set to if the Watchdog timer on this I/O unit expires, click Yes and choose On or Off from the drop-down list.

- When you have completed the fields, click OK.

The new point appears in the list.

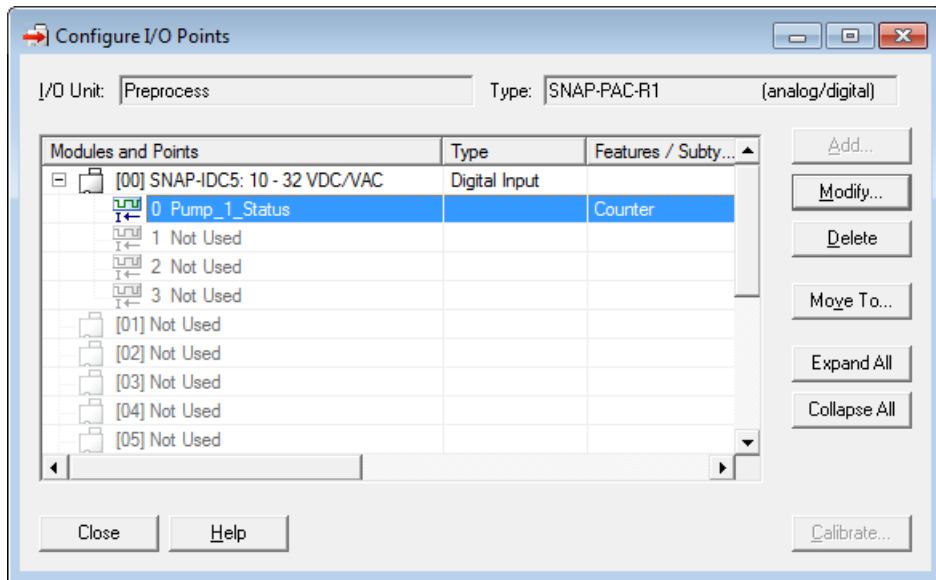

- To configure more digital points, repeat the steps. To configure analog points, see [page 54](#).

#### Configuring Digital Points for a G4EB2

Use the following steps to configure digital points on all G4 or Quad Pak digital modules supported by the G4EB2 brain. The G4EB2 replaces a 32-channel brain in a *mistic* or Pamux system with an Ethernet-based 32-channel digital brain that uses OptoMMP protocol. The G4EB2 brain is functionally similar to a SNAP-PAC-EB2 brain without analog I/O functionality. Input and output modules can be placed in any order.

- In the Configure I/O Units dialog box, highlight the digital I/O unit the points are on, and click I/O Points. The Configure I/O Points dialog box appears.

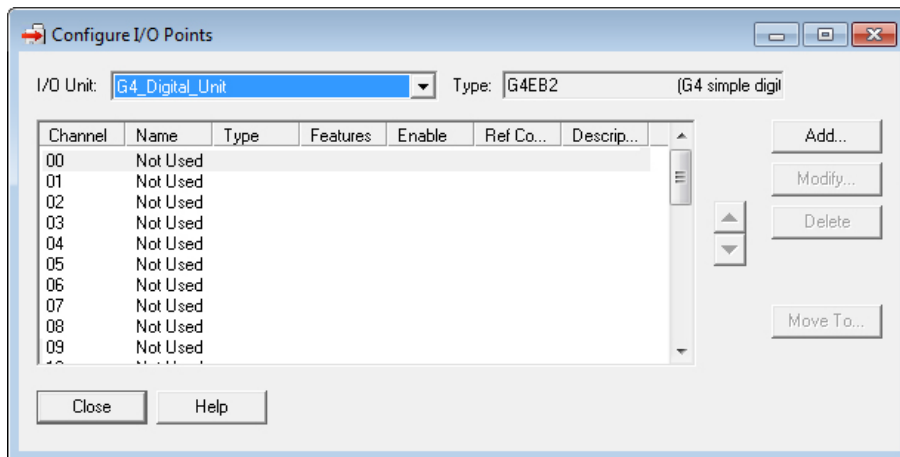

Points that have not been configured yet show as Not Used.

For **G4** modules, there is one channel per module. For **Quad Pak** modules, there are four channels per module which must be grouped together as shown.

Module Position	Channels Used
First	0–3
Second	4–7
Third	8–11
Fourth	12–15
Fifth	16–19
Sixth	20–23
Seventh	24–27
Eighth	28–31

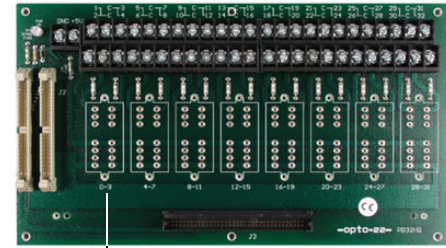

First module (channels 0–3)

- Double-click the channel number for the point you want to add. The Add Digital Point dialog box appears.

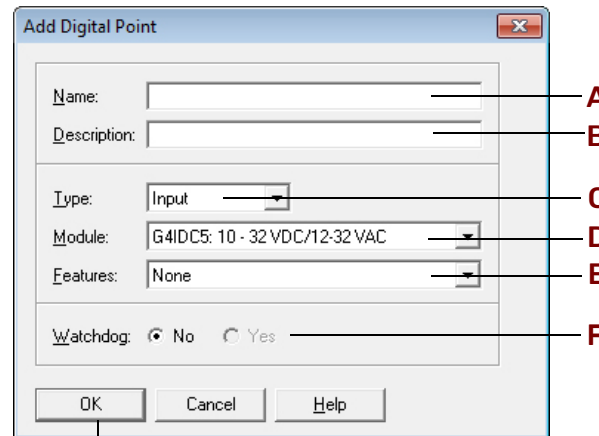

- Complete the fields as follows:

**A—Name.** Enter a name for the point. The name must start with a letter and may contain letters, numbers, and underscores. Spaces are converted to underscores.

**B—Description.** (Optional) Enter a description of the point.

**C—Type.** Select the type, either Input or Output.

**D—Module.** Select a module from the drop-down list.

**E—Features.** To use a feature of the module, choose it from the drop-down list. (See [“Using I/O Point Features” on page 85](#) for explanations of point features. Note that some features, such as pulsing and totaling, can be configured in PAC Manager but require PAC Control to use them.)

**F—Watchdog.** (Output modules only) To configure a status the point should be set to if the Watchdog timer on this I/O unit expires, click Yes and choose On or Off from the drop-down list.

- When you have completed the fields, click OK. The new point is added.

- To configure more digital points, repeat the steps.

PAC-R  
EB  
SB  
UIO  
EIO  
SIO  
E2

### Configuring Analog Points

About E1 and E2 brain boards: You can configure E1s and E2s like any other I/O unit if you have E1/E2 firmware R1.2a (and higher) and PAC Project 9.5000 (and higher). Also, if a SNAP PAC controller communicates with the E1 or E2, the controller must have PAC firmware R9.5a (or higher) to use this simplified configuration method. If you are not using these firmware and software versions (or if you prefer to use the previous method to reconfigure existing E1s or E2s), see [I/O Configuration for E1 and E2 Brain Boards \(form 1576\)](#).

NOTE: I/O points on mistic serial I/O units must be configured in PAC Control. SNAP PAC SBI/O units can be configured in either PAC Manager or PAC Control.

To configure points on analog modules supported by the brain or on-the-rack controller:

- In the Configure I/O Points dialog box, double-click the number that represents the analog module's position on the rack. (For help, see the diagrams starting on [page 173](#).)
- For a SNAP I/O unit, choose the module type and then the exact module part number from the list.

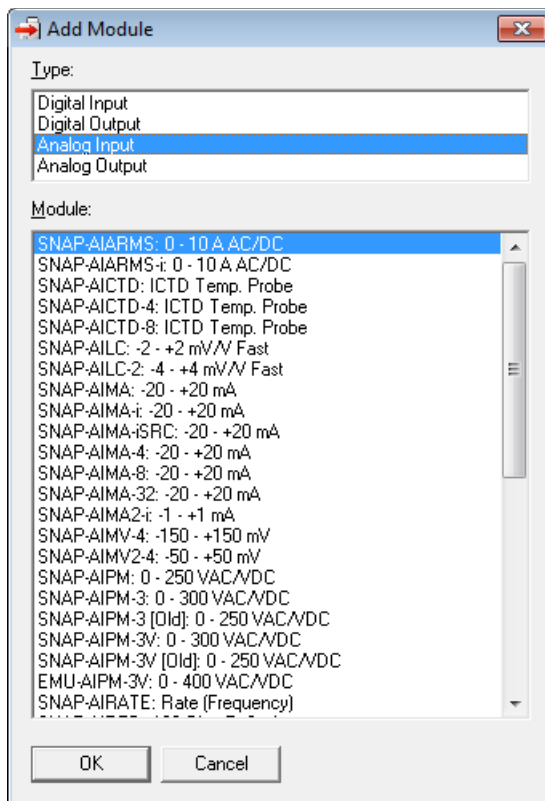

- Click OK.
- In the Configure I/O Points dialog box, click the plus sign next to the new module to expand it. Notice that the module icon is color-coded to reflect the type of module being configured: blue for analog input, green for analog output.



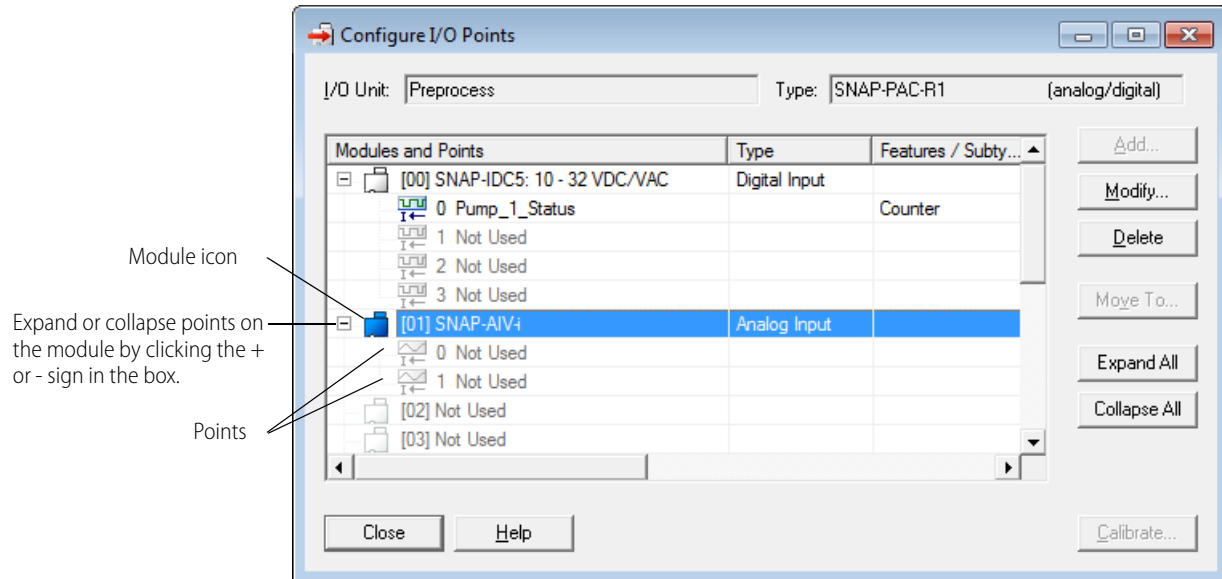

5. Double-click the point you want to configure.

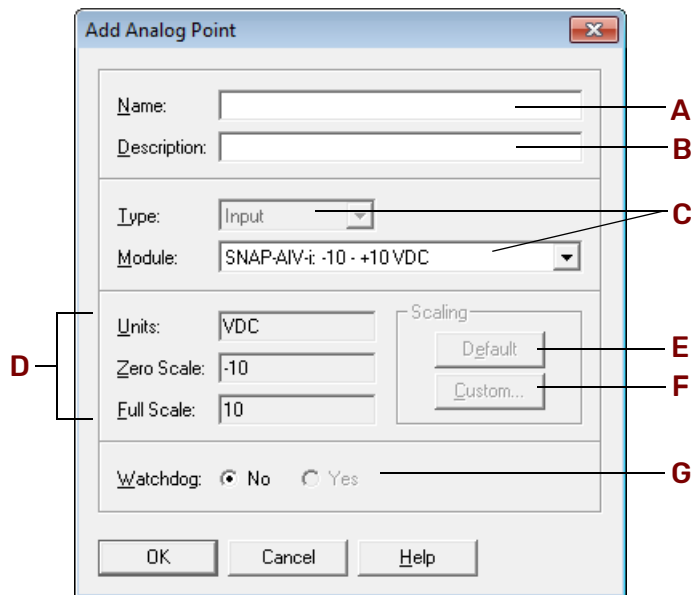

6. Complete the fields as follows:

**A—Name.** Enter a name for the point. The name must start with a letter and may contain letters, numbers, and underscores. (Spaces are converted to underscores.)

**B—Description.** (Optional) Enter a description of the point.

**C—Type, Module.** For a SNAP I/O unit, the type and module are inserted for you, but you may be able to choose a different range or module from the drop-down list.

**D—Units, Scale.** Units and scaling for this module. See [“Using Custom Scaling” on page 56](#).

**E—Scaling Default.** To return the units, zero-scale value, and full-scale value to the defaults for the module, click Default.

**F—Scaling Custom.** To assign custom units and values to the module, click Custom. For example, you could scale the voltage range of a -10 to +10 VDC module to be interpreted as engineering units of liters per second instead of volts. See “Using Custom Scaling” on page 56.

**G—Watchdog.** (Outputs only.) To configure a value this point should be set to if the Watchdog timer on this I/O unit expires, click Yes and enter the value.

- When you have completed the fields, click OK.  
The new point is added. This image shows a SNAP I/O unit.

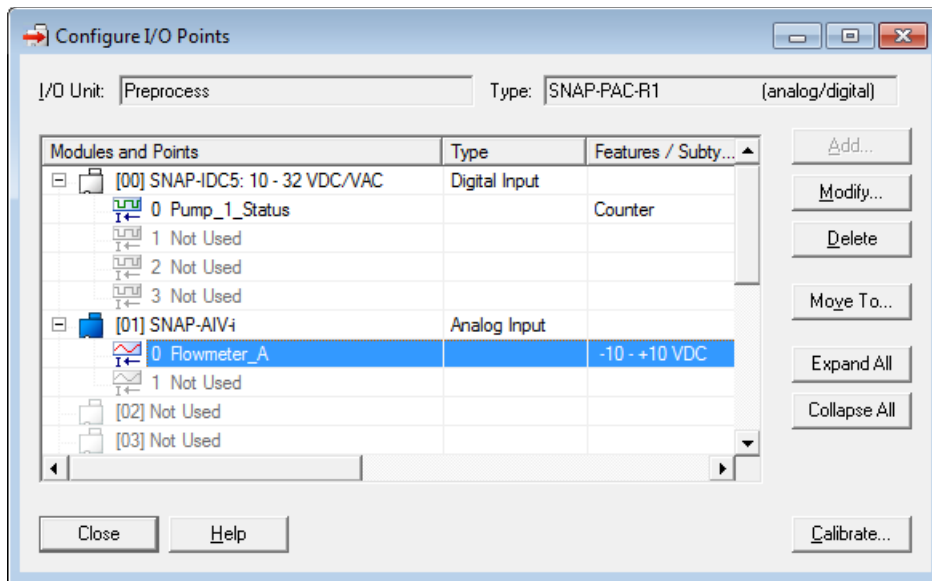

Point types and features are shown in the Features/Subtype column.

- To add more analog points, repeat the steps. To add digital points, see page 49.

### Using Custom Scaling

Analog modules can be set to show something other than the actual inputs or outputs. For example, you could scale the readings of a -10 to +10 VDC input point to measure its input as zero liters per second when the real-world reading is zero VDC, and 1000 liters per second when the real-world reading is five VDC.

Thermocouple values are not linear and cannot be scaled.

*NOTE: Custom scaling has no effect on the resolution or accuracy of the module.*

1. In the Add Analog Point dialog box, click the Custom button in the Scaling area to open the Scale Analog Readings dialog box.

This example shows units scaled to liters per second. At an actual input of 0 VDC, the point will show 0 liters per second. At an actual input of 5 VDC, the point will show 1000 liters per second.

Custom scaled values are floating point values:

- For analog input points with PAC firmware R8.0a and higher, you can use inverted scaling. Inverted scaling means the lower value is greater than the upper value; inverted scaling can accommodate a sensor, for example, that is wired to the SNAP module in a way that produces a negative current or voltage.
- For analog output points you cannot use inverted scaling. The upper value must be greater than the lower value.

2. Complete the fields as follows:

**A—Scaled Units.** Enter new engineering units for the module. The example uses liters per second.

**B—Actual Lower Value.** Enter the actual real-world lower value that the scaled lower value corresponds to. Note that inputs typically have under-range capability, which means you can specify a lower actual value that is less than the zero-scale value. Outputs do not have under-range capability.

**C—Scaled Lower Value.** Enter the new scaled lower value. This value can be any floating point value.

**D—Actual Upper Value.** Enter the actual real-world upper value that the scaled upper value corresponds to. For inputs, you can specify an upper actual value greater than the full-scale value.

**E—Scaled Upper Value.** Enter the new scaled upper value. For outputs, this value can be any floating point value greater than the scaled lower value. For inputs, it can be greater than or less than the scaled lower value. This example uses 1000, which scales the output to 1000 liters per second when its actual reading is 5 VDC.

3. Click OK.

The new custom-scaled units appear in the Add Analog Point dialog box.

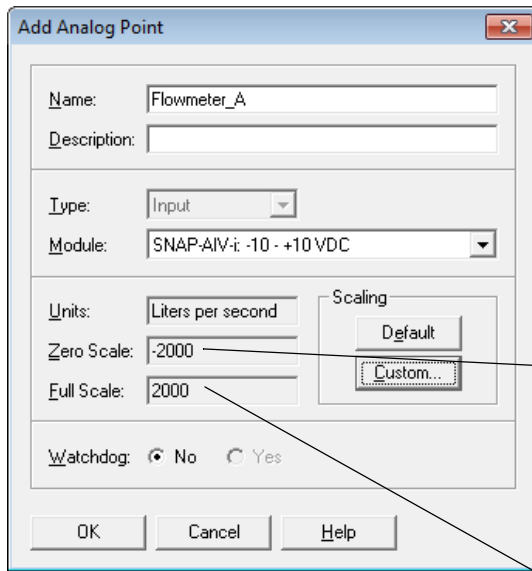

Notice the new units of liters per second and the new minimum-scale ("Zero Scale") and maximum-scale ("Full Scale") values of -2000 and +2000. The example connects a sensor with a range of 0–1000 liters per second, but an output of only 0–5 volts, to a SNAP-AIV module with an output of -10 to +10 volts. The figures shown reflect the total possible range of the module, not the sensor.

	Custom scale (Liters/sec)	Module's scale (VDC)
Possible low value for module	-2000	-10
	-1000	-5
Upper & lower values entered in dialog box	0	= 0
	1000	= 5
Possible high value for module	2000	10

PAC-R  
EB  
SB  
UIO  
EIO  
SIO

**Calibrating Offset and Gain**

This section describes how you can manually set offset and gain or have them automatically calculated and set for you.

*NOTE: You must use the manual method (page 60) if:*

- You don't have access to a calibrator, or
- The point uses inverted scaling and your device has PAC firmware R9.5b or lower. (In inverted scaling, the lower scaled value is greater than the upper scaled value.)

Starting with the introduction of SNAP-B3000-ENET, all SNAP PAC brains (including SBs), SNAP Ethernet I/O units, and E2 brain boards can automatically calculate offset and gain for analog input points. If a -50 mV to +50 mV input receives signals that are slightly off (for example, not exactly -50 mV at the lowest point), the offset and gain can be calculated so that values appear accurately when read.

Offset and gain values affect engineering units (EU). For a temperature input, engineering units are in degrees C or F, depending on how the I/O unit is configured.

**IMPORTANT:** *To calibrate the point, the I/O unit must be turned on and attached to the network, and you must have access to the I/O unit in order to use the calibrator. For points on a SNAP PAC SB-series brain, connect directly via serial or through the controller via Ethernet. (See page 39 for details.)*

*Save the configuration to flash so that it is not lost when power is turned off. Since each calibration is for a specific point on a specific I/O unit, the result cannot be saved to the configuration file and cannot be sent to any other I/O unit.*

First, calculate offset, and then calculate gain. The offset must be calculated at the signal corresponding to zero engineering units (EU), and the gain must be calculated at the signal corresponding to the point's maximum input range value (or, for inverted scaling, the point's minimum input range value—in inverted scaling, the lower scaled value is greater than the upper scaled value).

1. In the Configure I/O Points dialog box, highlight the analog input point you want to calibrate.

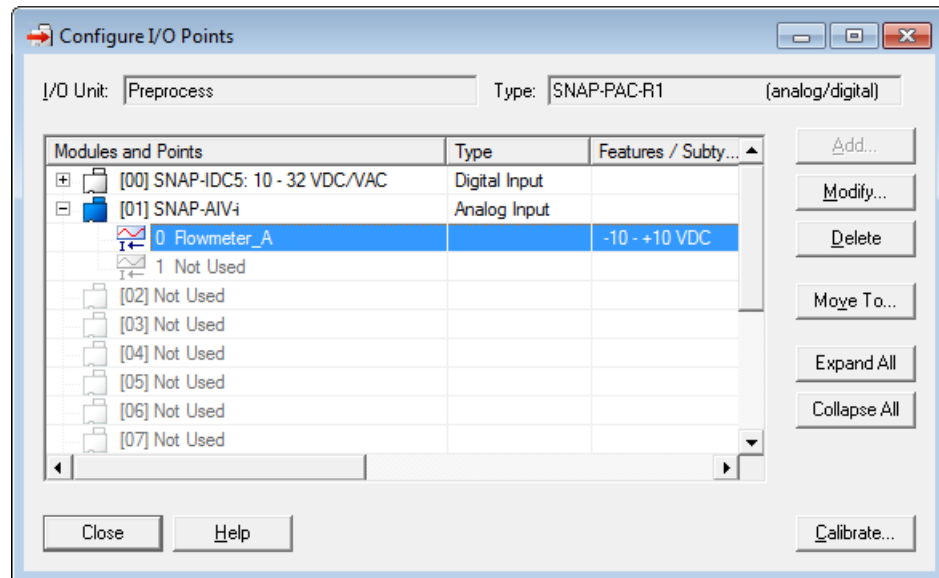

2. Click the Calibrate button in the lower-right corner of the dialog box.

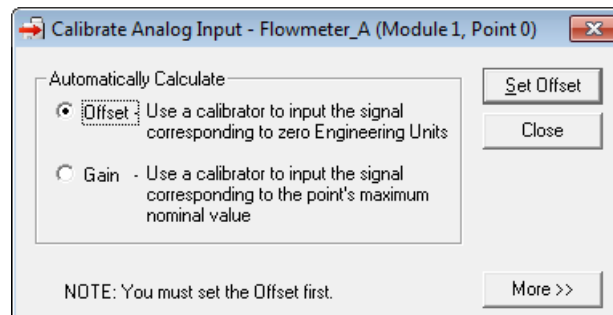

### To have the offset and gain calculated for you:

1. On the analog input point, use a calibrator to input the signal that corresponds to zero Engineering Units (EU).

Example 1: SNAP-AIV (-10 to +10 VDC) configured with default scaling

zero EU = 0 VDC

Example 2: SNAP-AIV (-10 to +10 VDC) configured with custom scaling

	Actual	Scaled
Units	VDC	PSI
Lower	-10	0*
Upper	+10	100

\*Zero EU is 0 PSI, which corresponds to a -10 VDC field signal

2. Click Offset, and then click the Set Offset button.
3. Use the calibrator to input the signal corresponding to the maximum input range value—or for inverted scaling, to the minimum input range value—for the configured point type. (In inverted scaling, the lower scaled value is greater than the upper scaled value.) For the exact values, refer to the configured Point Type or see the module's data sheet.

Example:SNAP-AIV module; Point Type of -10 to +10 VDC:

Maximum Input Range Value = +10 VDC

For inverted scaling, Minimum Input Range Value = -10 VDC

4. Click Gain, and then click the Set Gain button.

**To manually set offset and gain:**

- a. Click the More button.

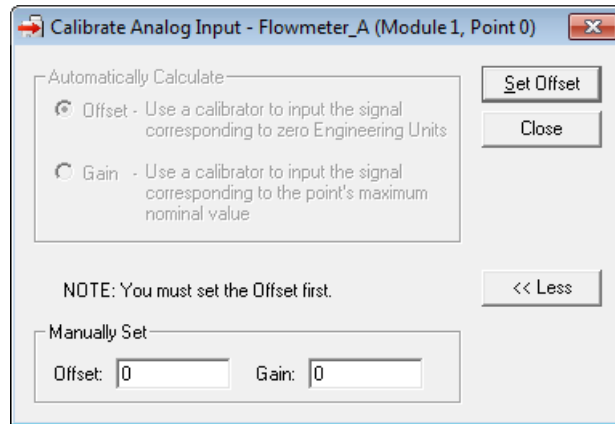

- b. Enter the Offset value. Click the Set Offset button.
- c. Enter the Gain value. Click the Set Gain button.

When you have finished calibrating the point, close the dialog box to return to configuring I/O points.

*NOTE: To store offset and gain values permanently, you must save the change to flash when you send the configuration data to the I/O unit (see page 83).*

PAC-R  
EB  
UIO  
EIO  
SIO

**Configuring RS-232 and RS-485/422 Serial Communication Modules**

*NOTE: For information on connecting a Windows serial application to a remote serial device through a SNAP Ethernet-based system, see the [SNAP Serial Communication Module User's Guide](#) (form 1191).*

(Not applicable to SB brains) RS-232 and RS-485/422 serial communication modules **do not require configuration** unless you need to change communication parameters such as port numbers or baud rates. Because these serial modules require no configuration, they do not appear in the Configure I/O Points dialog box in PAC Manager; you have to remember which positions on the I/O unit are filled with serial modules. For more information on these modules, see the [SNAP Serial Communication Module User's Guide](#) (form 1191).

Default port numbers are shown on [page 176](#). Default communication parameters are:

- 1 start bit (not configurable)
- 9600 baud
- No parity
- 8 data bits
- 1 stop bit
- No handshaking
- Send a test message when the module is turned on.
- SNAP-SCM-232: No flow control
- SNAP-SCM-485-422: 2-wire mode

Port numbers and all parameters except the last two (flow control and 2- or 4-wire mode) can be changed in the I/O unit's configuration file using the following steps. For flow control and 2- or 4-wire mode, see the steps on [page 62](#).

1. With the configuration file open, right-click the name of the I/O unit the serial module is on. From the pop-up menu, choose Configure.  
The Configure I/O Units dialog box opens.

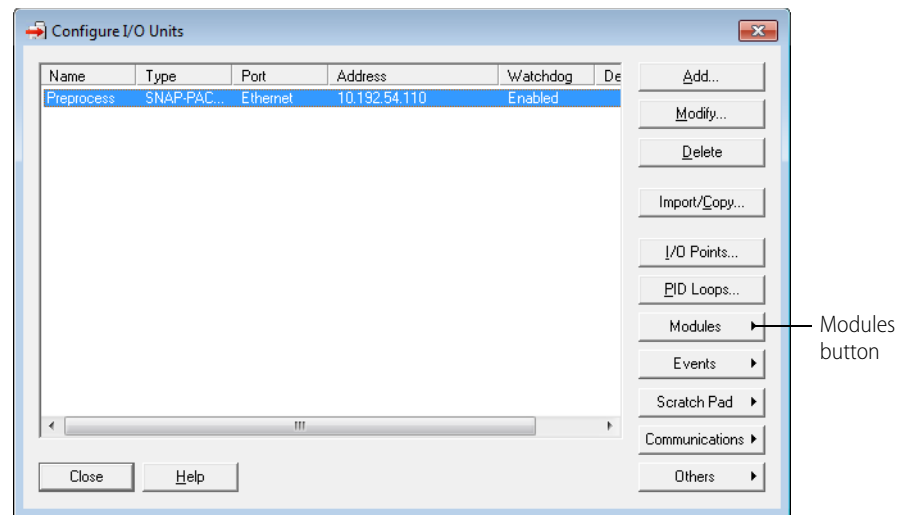

2. Make sure the correct I/O unit is highlighted. Click the Modules button and choose Serial Modules from the pop-up menu.

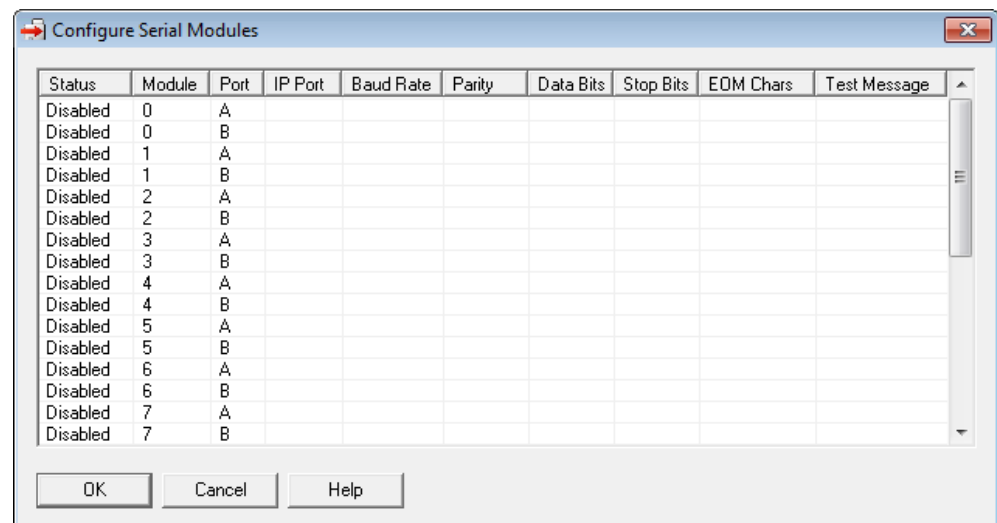

3. Click the status cell for the module number and port number whose parameters you want to change. From the pop-up menu, choose Enabled.  
The Status changes to Enabled.
4. To change a communication parameter, click the cell you want to change within the highlighted line. Choose from the drop-down list, if there is one, or type the new value in the cell.

*NOTE: The start bit is not configurable. To set flow control and 2- or 4-wire mode, see the steps on [page 62](#).*

*NOTE: EOM (end-of-message) characters apply only when using the serial module port with serial events (see page 159). The device can check any one of up to four characters as the EOM indicator, and you enter them in the field in hex. Example: 0x0D0A0000 looks for a 13 (hex 0D) or 10 (hex 0A).*

5. When you have finished changing parameters for serial modules, click OK to close the dialog box and return to configuring I/O units.

*IMPORTANT: If you have changed a TCP port number, you must save the change to flash and restart the I/O unit when you send the configuration data to the I/O unit (see page 83).*

**PAC-R  
EB  
UIO  
EIO  
SIO**

**Configuring Flow Control and 2- or 4-Wire Mode**

*IMPORTANT: You can configure flow control on a SNAP-SCM-232 and 2- or 4-wire mode on a SNAP-SCM-485-422 using PAC Manager. However, these configurations cannot be saved to the configuration file. The I/O unit that contains the serial module must be on the same network as your computer, and the configuration is sent directly to the I/O unit.*

1. In the PAC Manager main window, click the Inspect button .

The Inspect window opens.

- If you haven't used the Inspect window before, the window will not show any data.

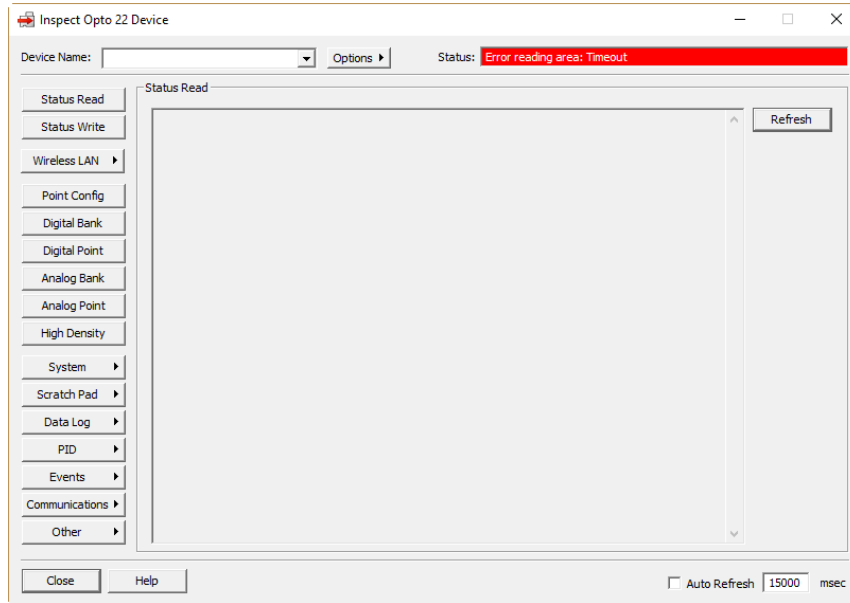



- If you *have* used the Inspect window before, the last device you inspected is shown in the Device Name field, and current Status Read information appears in the window.

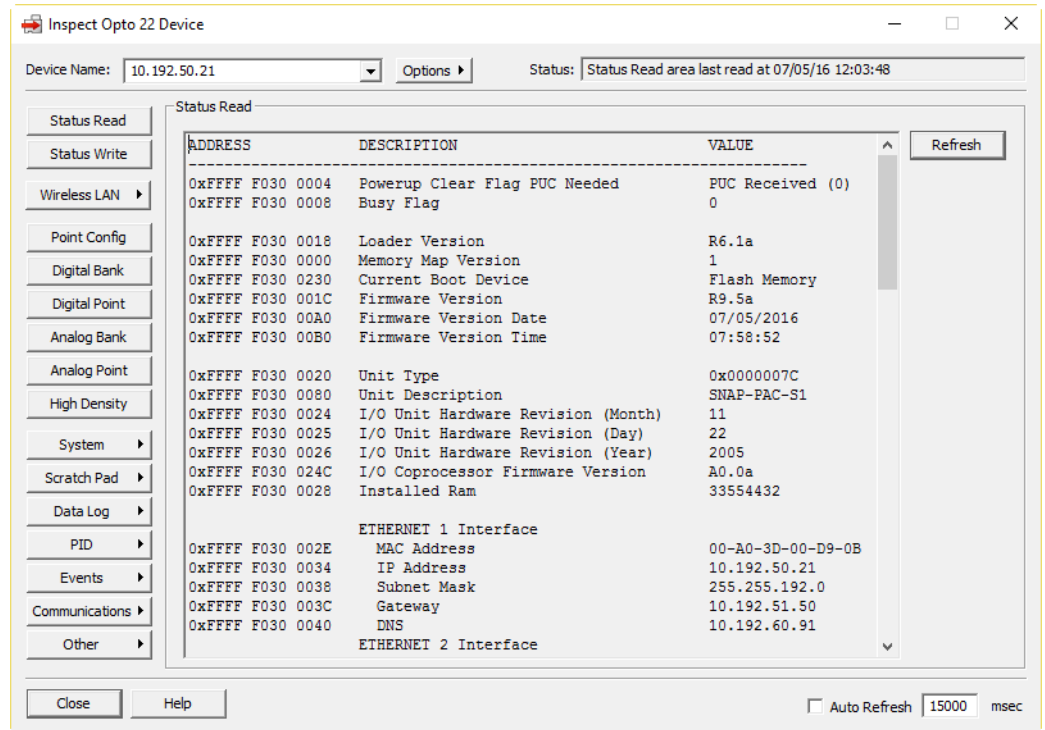

- If you have configured other devices, they are listed in alphabetical order in the drop-down list.
- If you have configured six or more devices, the Inspect window provides two additional time-saving features: Next and Back navigation buttons (to navigate back and forth through the alphabetized list of devices), and a list of the five most recently inspected devices (displayed at the top of the drop-down list).

Next and Back navigation buttons and Most Recently Used list are displayed when you have six or more devices configured.

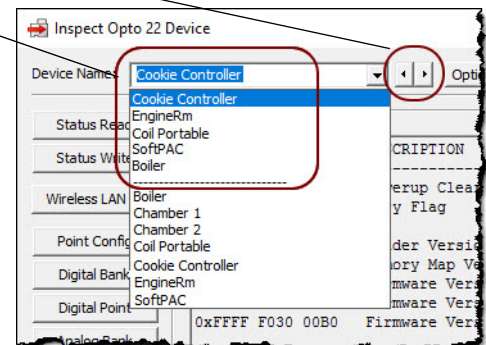

2. In the Device Name field, type the name of the I/O unit (any unique name, usually the name configured in PAC Control) or choose it from the drop-down list. (You can also enter the IP address.) Then click Refresh.

If the I/O unit has not been defined in PAC Manager, the Add New Device dialog box appears. Choose Direct Connection to Ethernet Device and enter the IP address of the device. Leave the Ethernet port at 2001 unless you have changed it on the device.

3. Click the Communications button and choose Serial Modules from the pop-up menu. Information from the I/O unit is displayed in the window.

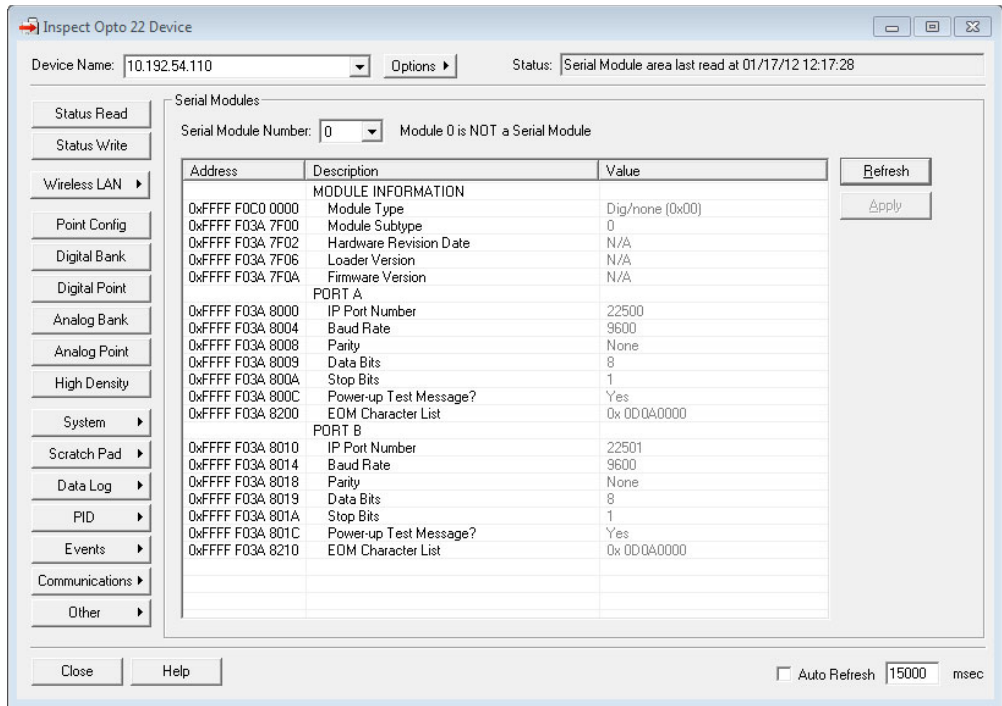

4. Click the Serial Module Number drop-down list and choose the module's position number on the rack to see the module's communication parameters.
5. To change a parameter, click its value in the Value column and choose from the drop-down list or enter a new value.

*NOTE: This is the only way to change hardware flow control for a SNAP-SCM-232 or 2- or 4-wire mode for a SNAP-SCM-485-422. You can also change other parameters in this dialog box if necessary. However, parameters changed in this dialog box are NOT saved to the configuration file.*

This example shows how to change Hardware Flow Control on a SNAP-SCM-232:

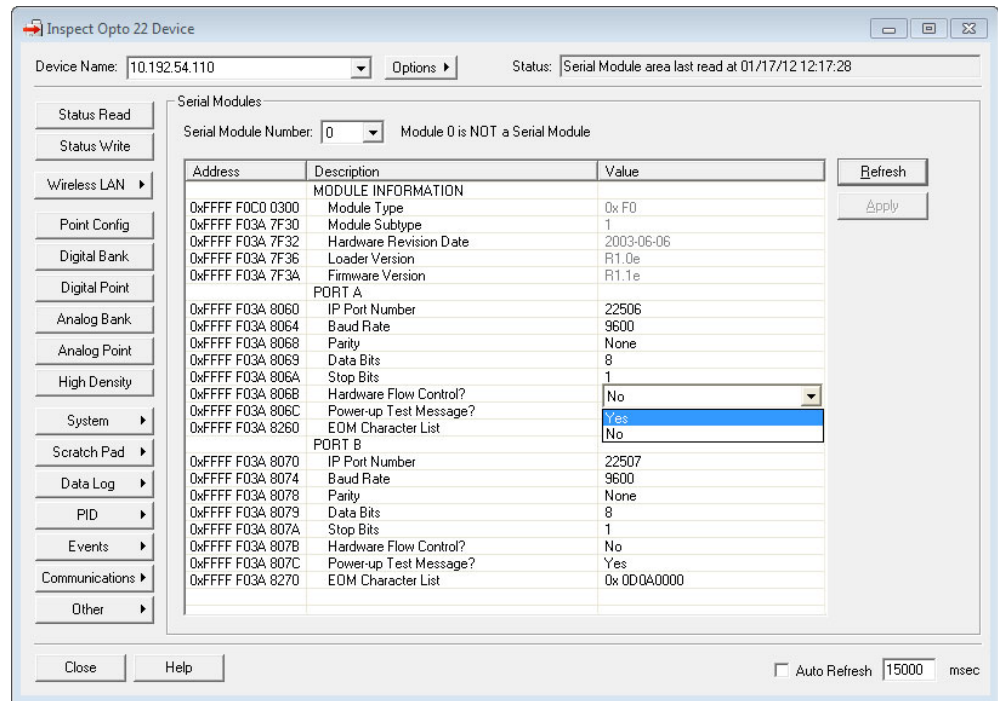

- When you have finished changing parameters for this module, click Apply. The configuration changes are sent to the I/O unit.

PAC-R  
EB  
UIO  
EIO

### Configuring Wiegand Modules

(Not applicable to SB brains) Wiegand modules are a type of serial module. Before configuring a Wiegand module, see the *SNAP Serial Communication Module User's Guide* (form 1191) for more information about these modules.

- With the configuration file open, right-click the name of the I/O unit the Wiegand module is on. From the pop-up menu, choose Configure. The Configure I/O Units dialog box opens.

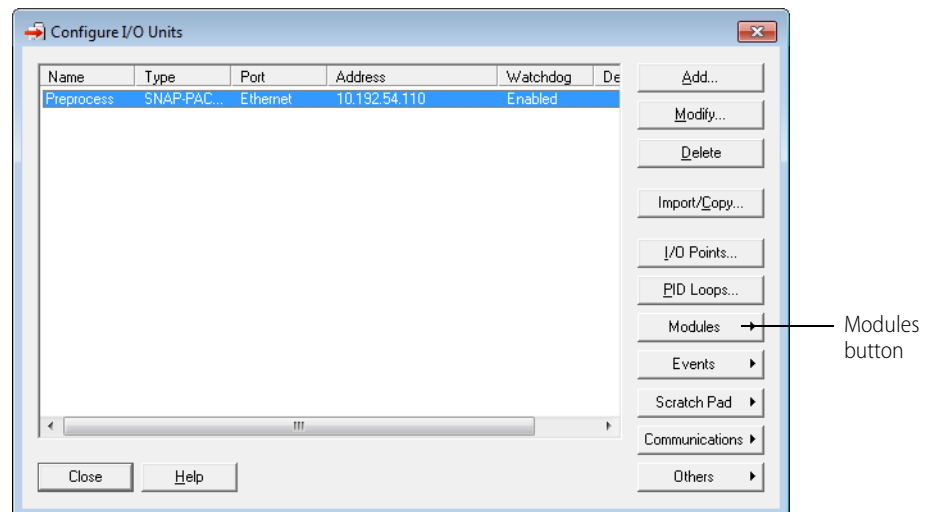

2. Make sure the correct I/O unit is highlighted. Click the Modules button and choose Wiegand Modules from the pop-up menu.

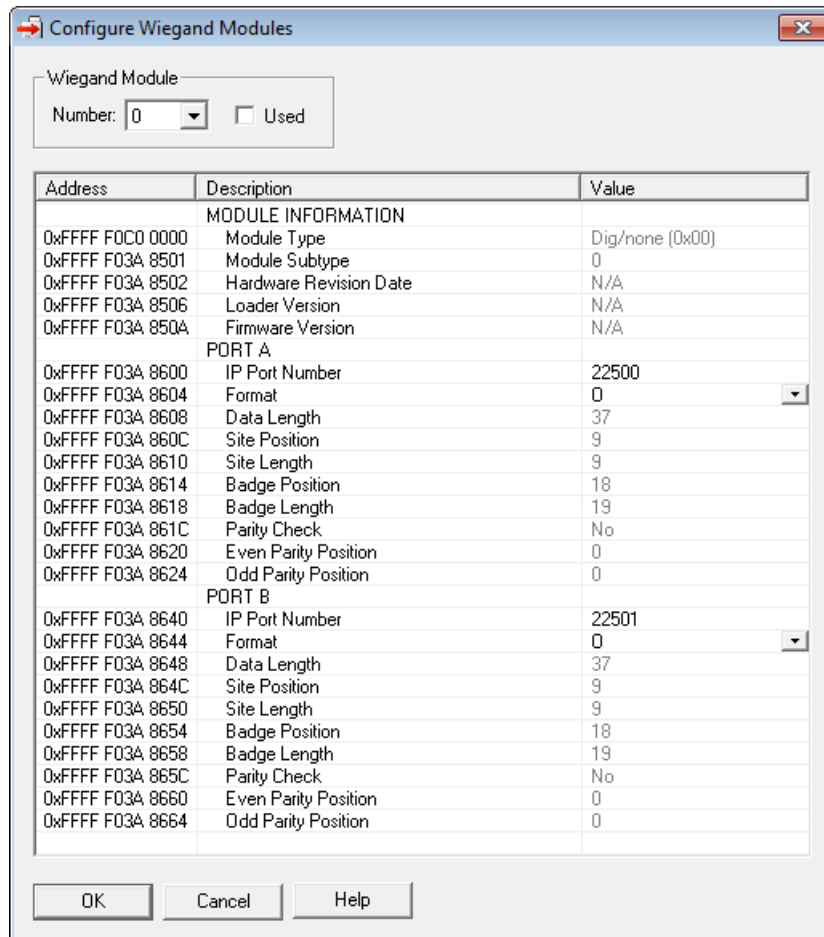

3. In the Number field, choose the Wiegand module's position from the drop-down list. Click to put a check mark in the Used box.
4. If you need to change port numbers, enter the new numbers for each port in the TCP port Number fields.
5. Click the Format/Value cell, and from the drop-down list, choose a standard data format (shown by its total data length) or choose C for custom.

*NOTE: 0 is the 37-bit Opto 22 format used in a sample PAC Control strategy available for use with Wiegand modules. For details, see the [SNAP Serial Communication Module User's Guide \(form 1191\)](#).*

6. Change the following fields if necessary to match your Wiegand hardware device:
  - Data Length—total length of data in the transmission
  - Site Position—first bit of the site code
  - Site Length—length of the site code, in bits
  - Badge Position—first bit of the badge code (should be the next bit after the site code)
  - Badge Length—length of the badge code, in bits
7. When data for both ports is correct, repeat from [step 3](#) for additional Wiegand modules.
8. When all Wiegand modules are configured, click OK to close the dialog box and return to configuring I/O units.

*IMPORTANT: If you changed a TCP port number, you must save the change to flash and restart the I/O unit when you send the configuration data to the I/O unit (see [page 83](#)).*

- When you are ready to send all configuration data to the I/O unit, see “[Sending Configuration Data to the I/O Unit](#)” on [page 83](#).

## Configuring PID Modules

*NOTE: This section is for legacy PID modules. These modules are not recommended for new development. Instead, use the PID loops provided on the I/O unit itself. SNAP PAC R-series, SNAP PAC EB, and SNAP PAC SB I/O units provide 96 PID loops each; SNAP Ultimate I/O units provide 32; SNAP Ethernet I/O units provide 16. See [page 78](#).*

To configure PID modules, you may also want to see the [SNAP PID Module User's Guide](#) (form 1263).

- In the Configure I/O Points dialog box, double-click the number that represents the PID module's position on the rack.
- In the Add Module dialog box, choose Analog Input as the type and then choose SNAP-PID-V as the module. Click OK.  
The module appears in the Configure I/O Points dialog box.
- Close the Configure I/O Points dialog box and return to the Configure I/O Units dialog box. Choose one of the following ways to enter PID values and set parameters for a SNAP-PID-V module:
  - If you want to iteratively tune a PID loop, use OptoENET PID Module Tuner. This software includes graphing features and is available free from the Opto 22 Web site. See the [SNAP PID Module User's Guide](#) (form 1263) for instructions; do NOT continue with the following steps.
  - If you have previously calculated PID values and parameters, use PAC Manager. PAC Manager does not provide visual feedback of changes to PID values. You must first calculate optimal PID values for your application using the PID velocity algorithm and the PID variable formulas described in the [SNAP PID Module User's Guide](#) (form 1263). After calculating these values, continue with [step 4](#).
- In the Configure I/O Units dialog box, click the Modules button and choose PID Modules from the pop-up menu.

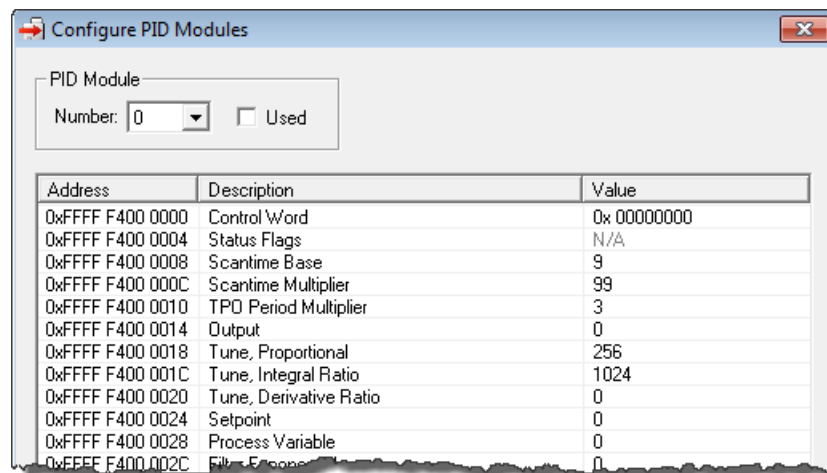

- From the Number drop-down list, choose the number of the PID module on the rack.
- Click to place a check mark in the Used box.
- For each item you want to set, click its cell in the Value column and change the value.  
For descriptions of items, see the [SNAP PID Module User's Guide](#) (form 1263).

8. Repeat for each PID module you want to configure.
9. When you have finished configuring PID modules, click OK to close the dialog box and return to configuring I/O units.

When you are ready to send all configuration data to the I/O unit, see [“Sending Configuration Data to the I/O Unit” on page 83](#).

**PAC-R**  
**EB**  
**UIO**  
**EIO**

### Configuring Profibus Modules

1. With the configuration file open, right-click the name of the I/O unit the Profibus module is on. From the pop-up menu, choose Configure. The Configure I/O Units dialog box opens.

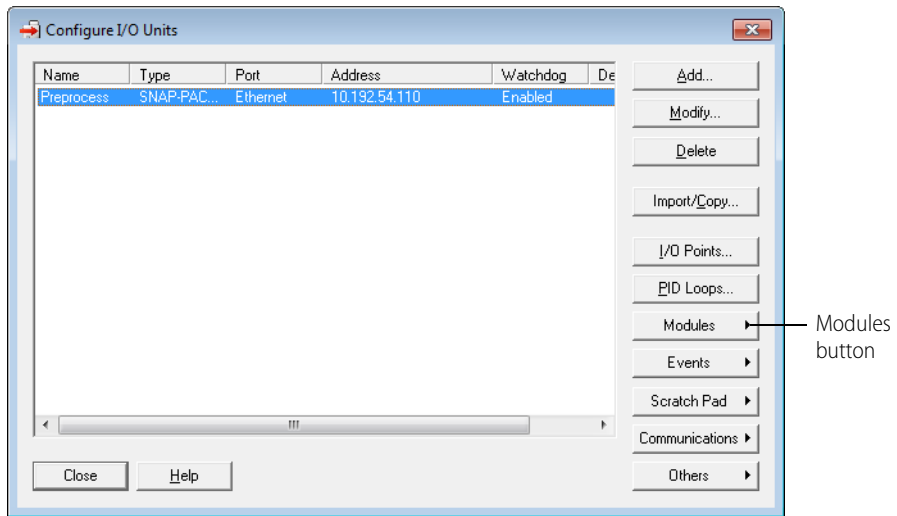

2. Make sure the correct I/O unit is highlighted. Click the Modules button and choose Profibus Modules from the pop-up menu.

Address	Description	Value
MODULE INFORMATION		
0xFFFF F0C0 0000	Module Type	Dig/none (0x00)
0xFFFF F03A 7F00	Module Subtype	0
0xFFFF F03A 7F02	Hardware Revision Date	N/A
0xFFFF F03A 7F06	Loader Version	N/A
0xFFFF F03A 7F0A	Firmware Version	N/A
PORT A		
0xFFFF F03A 8000	IP Port Number	22500
0xFFFF F03A 8004	Baud Rate	19200
0xFFFF F03A 8008	Parity	Even
0xFFFF F03A 8009	Data Bits	8
0xFFFF F03A 800A	Stop Bits	1
0xFFFF F03A 800B	Hardware Flow Control?	No
0xFFFF F03A 800C	Power-up Test Message?	Yes
0xFFFF F03A 8200	EOM Character List	0x 0D0A0000

3. In the Number field, choose the Profibus module's position from the drop-down list. Click to put a check mark in the Used box.
4. If you need to change port numbers, enter the new numbers for each port in the TCP port Number field.
5. Change the Baud Rate and EOM Character List fields if necessary to match your Profibus devices. Choose whether to have the module automatically send a Test Message when turned on (the default is Yes).
6. When data is correct, repeat from [step 3](#) for additional Profibus modules.
7. When all Profibus modules are configured, click OK to close the dialog box and return to configuring I/O units.
8. When you are ready to send all configuration data to the I/O unit, see [“Sending Configuration Data to the I/O Unit” on page 83](#).

*IMPORTANT: If you have changed a TCP port number, you must save the change to flash and restart the I/O unit when you send the configuration data to the I/O unit (see [“Sending Configuration Data to the I/O Unit” on page 83](#)).*

PAC-R  
EB  
SB

### Configuring SSI (Serial Synchronous Interface) Modules

Serial synchronous interface (SSI) modules (part number SNAP-SCM-SSI) are a special type of serial module. Unlike other serial modules, these can be used with SNAP PAC serial brains.

Before configuring an SSI module, see the [SNAP SSI \(Serial Synchronous Interface\) Module User's Guide](#) (form 1931) for information you will need to configure it.

1. With the configuration file open, right-click the name of the I/O unit the SSI module is on. From the pop-up menu, choose Configure.

The Configure I/O Units dialog box opens.

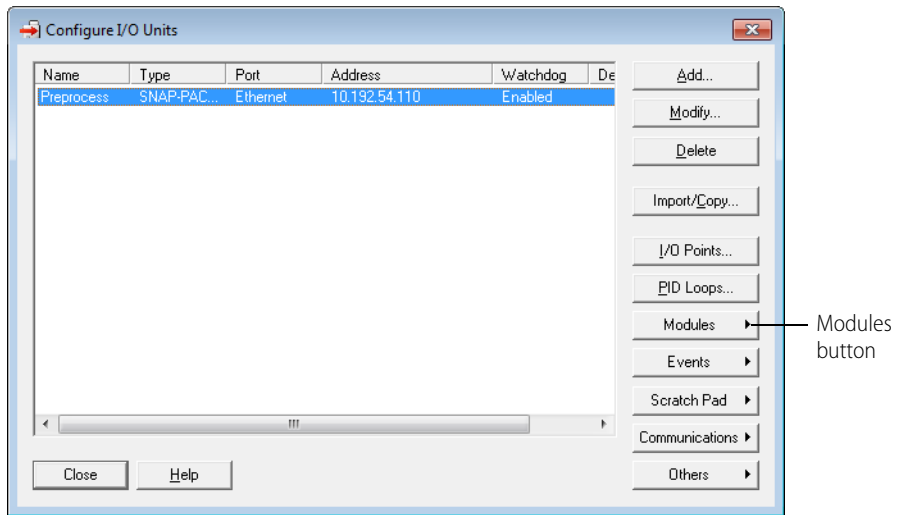

2. Make sure the correct I/O unit is highlighted. Click the Modules button and choose SSI Modules from the pop-up menu.

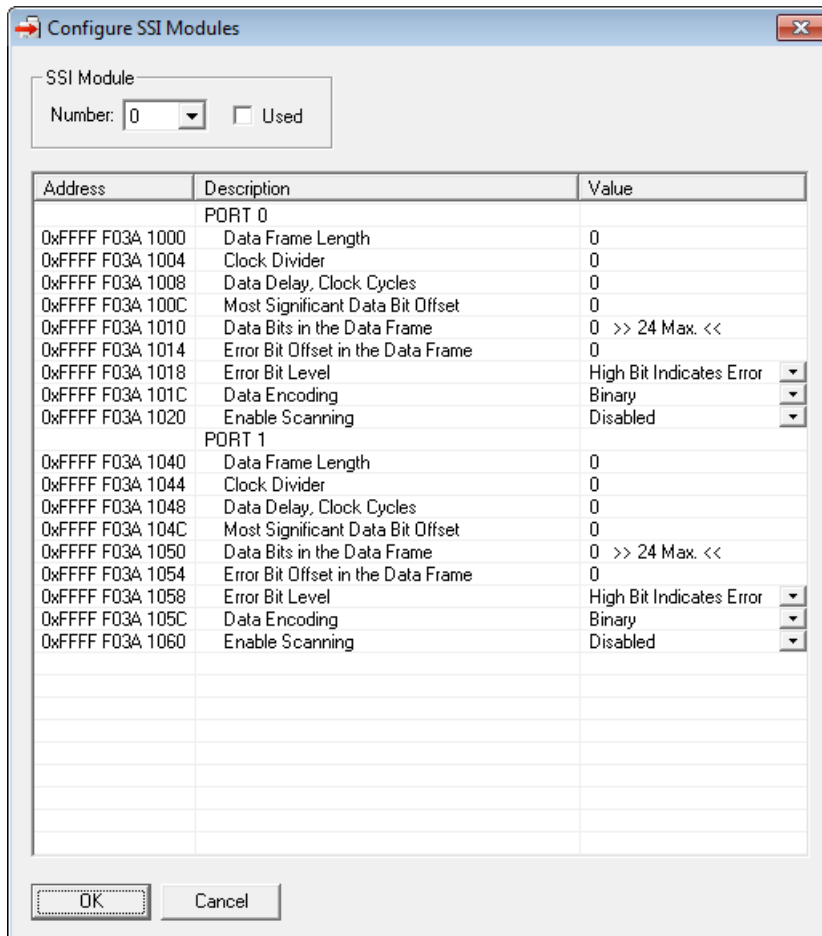



3. In the Number field, choose the SSI module's position from the drop-down list. Click to put a check mark in the Used box.
4. Configure all parameters for each port used. See the *SNAP SSI (Serial Synchronous Interface) Module User's Guide* (form 1931) to obtain the data for these fields. For each port, choose Enabled in the Enable Scanning field.
5. Repeat for additional SSI modules.
6. When all SSI modules are configured, click OK to close the dialog box and return to configuring I/O units.
7. When you are ready to send all configuration data to the I/O unit, see "Sending Configuration Data to the I/O Unit" on page 83.

**PAC-R  
EB**

## Configuring CAN Modules

The SNAP-SCM-CAN2B provides an interface to a Controller Area Network (CAN) that allows your SNAP PAC system to receive data from CAN devices. Before configuring a CAN module, see the *SNAP SSI (Serial Synchronous Interface) Module User's Guide* (form 1931) for more information about these modules.

Configuration for the SNAP-SCM-CAN2B module is normally done in a PAC Control strategy using the example subroutine from the CAN RX/TX Integration Kit for PAC Project, part number PAC-INT-CAN-RXTX, a free download available on our website, [www.opto22.com](http://www.opto22.com). As described below, you can also use PAC Manager to change the IP Port Number, Baud Rate, Data Masks, or Filters for the SNAP-SCM-CAN2B serial module. However, the settings in your strategy will override the settings in PAC Manager for each module.

1. With the configuration file open, double-click the I/O Units folder.  
The Configure I/O Units dialog box opens.

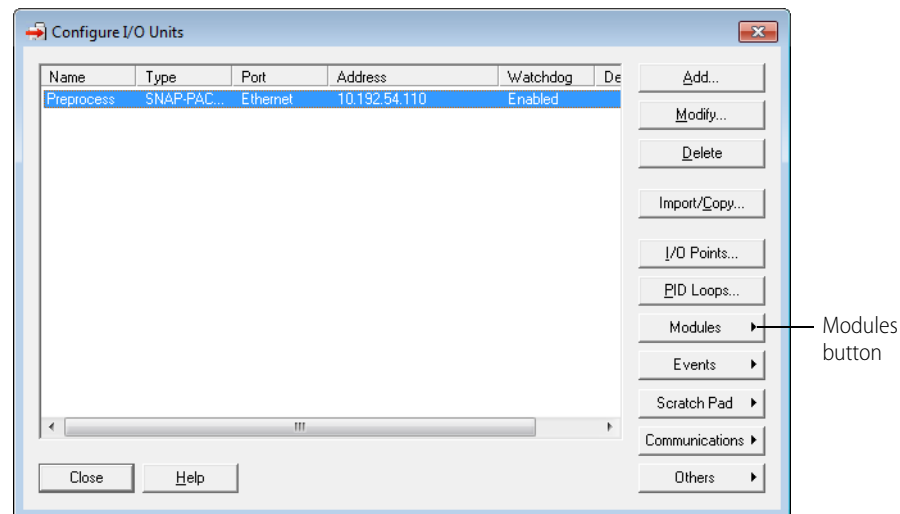

2. Highlight the I/O unit the CAN module is on. Click the Modules button and choose CAN Modules from the pop-up menu.  
Information from the I/O unit is displayed in the window.
3. Click the CAN Module number dropdown list and choose the module's position number on the rack to see the module's communication parameters.

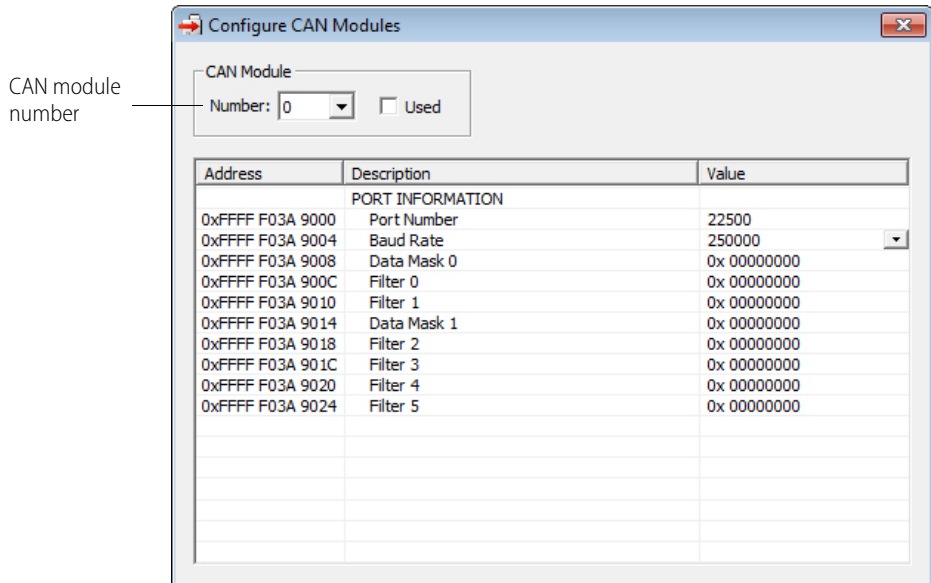

- To change a parameter, click its value in the Value column.  
To change the Baud Rate on a SNAP-SCM-CAN2, choose from the drop-down list



To change the Filter or Data Mask values, see the next section below.

- When you have finished changing parameters for this module, click OK.
- Repeat the previous step for additional CAN modules.
- When all CAN modules are configured, click OK to close the dialog box and return to configuring I/O units.
- When you're finished configuring I/O units, close the dialog box. Choose File > Save to save the configuration file.
- When you are ready to send all configuration data to the I/O unit, see ["Sending Configuration Data to the I/O Unit"](#) on page 83.

#### SNAP-SCM-CAN2B Filters and Data Masks

The filters and data masks for each CAN2B module are normally configured in a PAC Control strategy using the sample subroutines provided in the CAN RX/TX Integration Kit for PAC Project, part number PAC-INT-CAN-RXTX. You can also use PAC Manager to configure these settings. However, the filter and data mask settings in your PAC Control strategy will override the settings in PAC Manager for each module.

In PAC Manager the Data Masks and Filters are all set to 0 by default, which means that all CAN packets will be received. If you want the SNAP-SCM-CAN2B module to provide filtering, then configure the Data Masks and Filters.

Always start with the highest priority mask and filter, Data Mask 0 and Filter 0. Mask 0 uses Filter 0 and Filter 1, in that order. Then Data Mask 1 uses Filters 2–5, in that order.

Address	Description	Value
PORT INFORMATION		
0xFFFF F03A 9000	Port Number	22500
0xFFFF F03A 9004	Baud Rate	250000
0xFFFF F03A 9008	Data Mask 0	0x 00000000
0xFFFF F03A 900C	Filter 0	0x 00000000
0xFFFF F03A 9010	Filter 1	0x 00000000
0xFFFF F03A 9014	Data Mask 1	0x 00000000
0xFFFF F03A 9018	Filter 2	0x 00000000
0xFFFF F03A 901C	Filter 3	0x 00000000
0xFFFF F03A 9020	Filter 4	0x 00000000
0xFFFF F03A 9024	Filter 5	0x 00000000

Masks and filters each consist of 32 bits; in PAC Manager these are entered in hex. The mask determines how broadly or narrowly the filter will be applied, that is, which bits of the CAN ID to pay attention to when deciding to accept or reject a CAN packet. The following table shows how the mask and filter work together.

Mask Bit	Filter Bit	CAN ID Bit	Accept/Reject
0	X*	X*	Accept
1	0	0	Accept
1	0	1	Reject
1	1	0	Reject
1	1	1	Accept

\* X = Don't Care

The configuration examples below show how to build the masks and filters.

These examples assume you are using module firmware 2.0b or higher.

**Example 1**

Suppose many CAN frames are placed on the bus at regular intervals (in no particular order). Some are standard CAN frames; others are extended CAN frames. You are interested in only one frame, an extended CAN frame with an Arbitration ID of: 0x14613A2C

This is the only frame you want to capture. How do you configure the Mask and Filter fields to capture it?

Parameter	Value	Description
Mask 0	0x1FFFFFFF	A mask with all bits set means the module should consider each bit of the arbitration ID for acceptance. This makes the filter more stringent.
Filter 0	0x54613A2C	Since this is an extended CAN frame, you want the filter to apply to extended CAN frames received. So bitwise OR the Arbitration ID with the Extended ID Enable (EXIDE) flag. This flag tells the brain that the filter should apply to extended CAN frames. The value of this flag is 0x40000000.
Filter 1	0x0	Not used, since you are interested in only one CAN frame.
Mask 1	0x0	Not used
Filters 2 - 5	0x0	Not used

Here are representations of the 32-bit mask and the 32-bit filter for this example:

**Mask 0**

Bits:	31	30	29	28	27	26	25	24	23	22	21	20	19	18	17	16	15	14	13	12	11	10	9	8	7	6	5	4	3	2	1	0
Bit values:	0	0	0	1	1	1	1	1	1	1	1	1	1	1	1	1	1	1	1	1	1	1	1	1	1	1	1	1	1	1	1	1

Mask in hex: 

1	F	F	F	F	F	F	F
---	---	---	---	---	---	---	---

**Filter 0**

For data in an extended frame, set the EXIDE flag, which is bit 30. The Arbitration ID of 0x14613A2C becomes 0x54613A2C when bit 30 is set:

	Not used	EXIDE flag	Not used	<b>Arbitration ID</b>																												
Bits:	31	30	29	28	27	26	25	24	23	22	21	20	19	18	17	16	15	14	13	12	11	10	9	8	7	6	5	4	3	2	1	0
Bit values:	0	1	0	1	0	1	0	0	0	1	1	0	0	0	0	1	0	0	1	1	1	0	1	0	0	0	1	0	1	1	0	0
Filter in hex:	5			4				6					1		3			A			2		C									

**Example 2**

Building on Example 1, suppose now you decide that in addition to the extended CAN frame with Arbitration ID 0x14613A2C you also want to capture a standard CAN frame with Arbitration ID 0x1EC.

For this second frame you have two options:

- You could put the standard frame at Filter 1 so that both frames are using Mask 0.
- You could use a different mask, Mask 1, and use Filter 2.

In either case you need to map the 11-bit (standard) Arbitration ID to the 32-bit value the module is expecting. The module expects the 11-bit standard ID to be in bits 28–18 of the 32-bit filter. So, in terms of math: mask the desired 11-bit Arbitration ID with 0x7FF and then left-shift by 18 bits:  $((11\text{-bit Arbitration ID}) \& 0x7FF) \ll 18$

**Using Mask 0.** Mask 0 is already considering each bit in the Arbitration ID, and since we only want to look at these two CAN frames, we could use Filter 1.

Parameter	Value	Description
Mask 0	0x1FFFFFFF	A mask with all bits set means the module should consider each bit of the arbitration ID for acceptance. This makes the filter more stringent.
Filter 0	0x54613A2C	Since this is an extended CAN frame, you want the filter to apply to extended CAN frames received. So bitwise OR the Arbitration ID with the EXIDE flag.
Filter 1	0x07B00000	Value of standard Arbitration ID filter after mapping it to its 32-bit value. Do not set the EXIDE flag. In this case the lower 18 bits (the extended arbitration bits) are excluded from the acceptance check, even though the mask would indicate otherwise, since this is a standard CAN frame filter.
Mask 1	0x0	Not used
Filters 2 - 5	0x0	Not used

**Using Mask 1.** If Mask 0 were less stringent (fewer set bits) so it would not cause acceptance of just the 0x1EC Arbitration ID, then you could use the Mask 1 and Filter 2.

Parameter	Value	Description
Mask 0	0x1C63FFFF	A Mask with much less stringent acceptance criteria. The set mask bits are used in the comparison with the filter, while the cleared bits are “Don't Care.”

Parameter	Value	Description
Filter 0	0x54613A2C	Since this is an extended CAN frame, we want the filter to apply to extended CAN frames received. So bitwise OR the Arbitration value with the EXIDE flag. (Depending on the Arbitration IDs of other CAN frames on the bus, other extended CAN frames will also be accepted, for example 0x15613A2C, 0x16613A2C, 0x17613A2C, 0x14713A2C, and so on.)
Filter 1	0x0	Not used
Mask 1	0x1FFC0000	A mask stringent on the standard arbitration bits but allowing all the extended arbitration bits.
Filter 2	0x07B00000	Value of standard Arbitration ID filter after mapping it to its 32-bit value. Do not set the EXIDE flag. This filter captures only the 0x1EC standard CAN frame.
Filter 3 - 5	0x0	Not used

**PAC-R  
EB**

### Configuring HART Modules

HART® SNAP I/O are a special type of serial module that provides communication with other Highway Addressable Remote Transducer (HART) current loop devices. For more information, see the [HART SNAP I/O Modules Data Sheet](#) (form 2080).

1. With the configuration file open, right-click the name of the I/O unit the HART module is on. From the pop-up menu, choose Configure.

The Configure I/O Units dialog box opens.

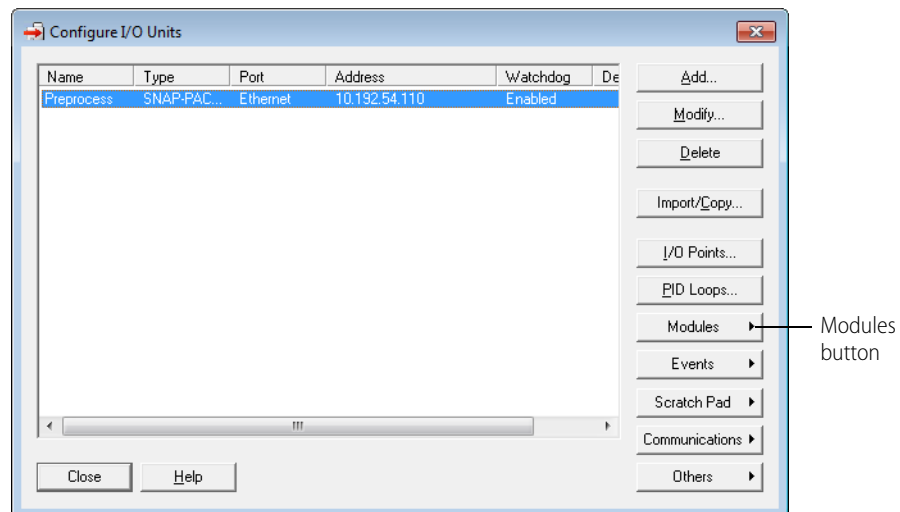

2. Make sure the correct I/O unit is highlighted. Click the Modules button and choose HART Modules from the pop-up menu.

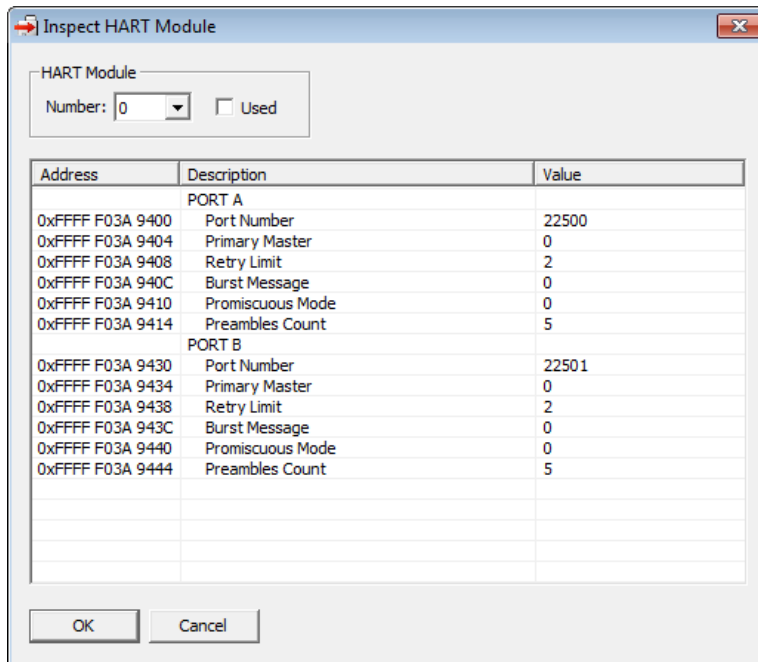

3. In the Number field, choose the HART module's position from the drop-down list. Click to put a check mark in the Used box.
4. Configure all parameters for each port used.
  - **Port Number:** If you need to change port numbers, enter a new number for each port in the Port Number field.
  - **Primary Master:** 0 = Secondary Master, 1 = Primary Master  
 A master is a device that is in control of the HART Bus. Either master (Primary or Secondary) can initiate a transaction with a slave field device attached to the bus.  
 If you want a permanent master connected to the HART bus, use Primary Master = 1. This allows you to temporarily attach another master device to configure a device or troubleshoot the HART bus.
  - **Retry Limit:** 0, 1, 2, 3, 4, or 5  
 If the module does not receive a valid message from the slave device it is talking to, it will automatically send up to the configured number of retries until it gets a valid response. If it does get a valid response after the maximum number of retries, it will report back that an error occurred.
  - **Burst Message:** 0 = Don't report burst messages, 1 = Report burst messages  
 A burst message occurs in a special mode where one slave device on the HART Bus is periodically sending data without a request generated by a master device. Burst messages can be retrieved using the Receive HART Burst Response command in your PAC Control strategy. For more information, see the Analog group of commands in the [PAC Control Command Reference](#) (form 1701).
  - **Promiscuous Mode:** 0 = Don't report other master requests/responses, 1 = Report other master requests/responses.  
 When enabled (1), the module reports transactions initiated by the other master on the bus, including requests generated by the other master and responses to those requests by the addressed slave. You can retrieve Promiscuous Mode messages using the Receive HART Burst Response

- command in your PAC Control strategy. For more information, see the Analog group of commands in the [PAC Control Command Reference](#) (form 1701).
- **Preambles Count:** 5 to 20  
Preamble characters are sent with every message to indicate that data is about to be transmitted. The default of 5 should work in most situations. However, you might need to increase the number if the slave device requires more preamble characters, which is generally true of older HART devices and can be determined using HART command 0.
5. Repeat the previous step for additional HART modules.
  6. When all HART modules are configured, click OK to close the dialog box and return to configuring I/O units.
  7. When you are ready to send all configuration data to the I/O unit, see [“Sending Configuration Data to the I/O Unit” on page 83](#).

### Moving a Configured I/O Point

You can move a configured I/O point to an empty position on the same I/O unit or on a different I/O unit.

1. In the Configure I/O Unit dialog box, highlight the unit the point is on and click I/O Points. The Configure I/O Points dialog box opens.
2. If necessary, expand the modules by clicking Expand All.
3. Highlight the point you want to move and click Move To.

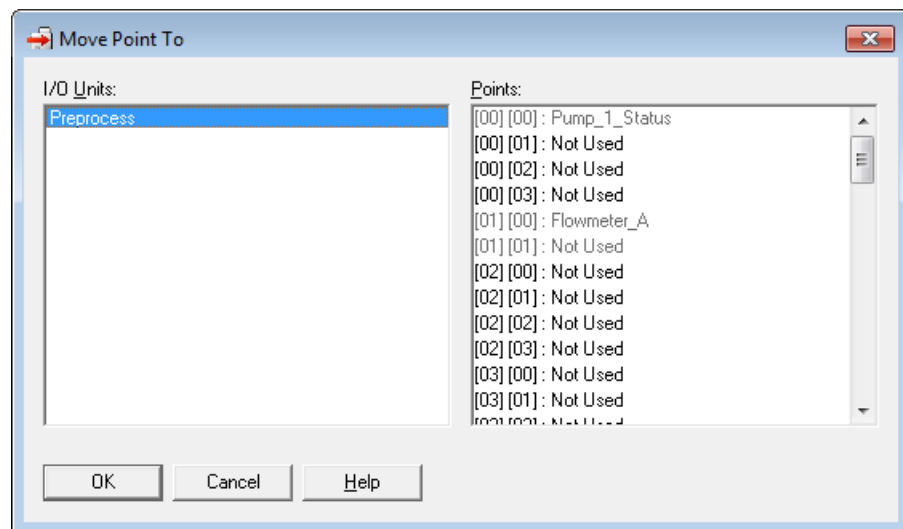

4. In the Points area of the Move Point To dialog box, highlight the location you are moving the point to. Then click OK.  
You return to the Configure I/O Points dialog box, and the point has been moved.

## COPYING AND PASTING I/O UNITS

PAC-R  
EB  
SB  
UIO  
EIO  
SIO  
E1  
E2

You can copy configured I/O units and paste them into the same configuration file or into another configuration file.

1. In the configuration tree, right-click the name of the I/O unit. On the submenu, click Copy.
2. Choose one of the following:

- To paste the I/O unit into the same configuration file, right-click the I/O Units folder and click Paste on the submenu. The I/O unit is pasted. As shown in the graphic at right, the names of the pasted I/O unit and points are the same as the originals, except with an underscore and a number added.
- To paste the I/O unit into a different configuration file, close the first file, and then open the file into which you want to paste the I/O unit. Right-click the I/O Units folder in the configuration tree. On the submenu, click Paste. The I/O unit is pasted. To see it in the configuration tree, you can click the plus sign to expand the folder.

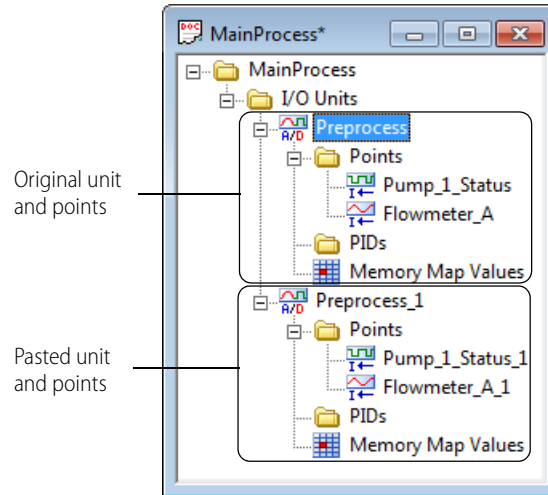

3. To change the name or configuration of the pasted I/O unit, double-click it. Make the changes in the Edit I/O Unit dialog box and then click OK.
4. To change the name or configuration of a point on the pasted unit, double-click the point's name. Make changes in the dialog box and then click OK.

## CONFIGURING PID LOOPS

*NOTE: This section applies only to PID loops on SNAP PAC R-series, EB, and SB, SNAP Ultimate, and SNAP Ethernet I/O units. It does not apply to PID loops on mistic brains, such as the B3000 serial. PID loops for mistic brains used with PAC Control must be configured in PAC Control.*

**PAC-R  
EB  
SB  
UIO  
EIO**

### What is a PID?

PID loops (or simply PIDs) are used to drive an input (process variable) toward a particular value (the setpoint) and keep the input very close to that value by controlling an output. For example, consider temperature control, where the input is a measurement of ambient temperature, the setpoint is the desired temperature, and the output is a heater. A PID will use a mathematical formula (*algorithm*) that controls the output to maintain a desired temperature, efficiently adjust to changes in setpoint, and compensate for changes in load, such as the influx of cold air. In this example, a temperature sensor (analog input), a thermostat (analog input), and a heater control (analog output) are components of one system, controlled by a PID loop.

This guide assumes that you are already familiar with using PIDs. PID calculations are complex and the physical qualities of systems suitable for PID control differ greatly. This guide includes only basic information for configuring PIDs on SNAP PAC Ethernet-based I/O units.

SNAP PAC R-series I/O units support 96 PID loops per I/O unit; SNAP PAC EB and SB I/O units support 32 PID loops per I/O unit. Analog/digital SNAP Ultimate I/O units support 32 PID loops per I/O unit, and SNAP Ethernet I/O units support 16. (SNAP Simple I/O units do not have PID capability.) These PIDs can control isolated systems or be part of cascaded systems where one loop controls the setpoints or input variables of others.

*NOTE: On SNAP PAC R-series and SNAP Ultimate, PID loops run on the I/O side, independent of any PAC Control strategy. Once it starts running, a PID continues running until the I/O unit loses power or the PID is set to Manual. If you subsequently download a different strategy to the control engine, you'll receive an error message (-700) reminding you that a PID loop is still running and that it may conflict with the new strategy. To turn off the PID loop, use Inspect mode in PAC Manager to change the PID's algorithm to None.*



Each PID must be configured with essential parameters and then individually tuned for efficiency. You can configure PIDs through either PAC Manager or PAC Control. For tuning PIDs, it's easier to use the graphic tuning tools in PAC Control. (For details, see the [PAC Control User's Guide](#), form 1700.)

*NOTE: PID capabilities in SNAP Ethernet I/O units are compatible with PAC Control, but not with OptoControl.*

If you are not using PAC Control, it is possible to configure and tune PIDs through the I/O unit's memory map. The memory map is in the [OptoMMP Protocol Guide](#) (form 1465).

For additional help with PIDs, see the [OptoTutorial: SNAP PAC PID](#) (form 1641).

## Algorithm Choices

(Does not apply to *groov* I/O units or *groov* RIO modules.) When you configure a PID loop, choose one of these algorithms<sup>2</sup>:

- Velocity (Type C)
- ISA
- Parallel
- Interacting

Velocity (Type C) is typically used to perform velocity control. The ISA, Parallel, and Interacting algorithms are derived from the article "A Comparison of PID Control Algorithms" by John P. Gerry in *Control Engineering* (March 1987). These three equations are the same except for the tuning coefficients; converting from one equation to another is merely a matter of converting the tuning coefficients.

### Key to Terms Used in Equations

PV	Process variable; the input to the PID
SP	Setpoint
InLo, InHi	Range of the input
OutLo, OutHi	Range of the output
Gain	Proportional tuning parameter. Unitless. May be negative.
TuneI	Integral tuning parameter. In units of seconds. Increasing magnitude increases influence on output.

TuneD	Derivative tuning parameter. In units of seconds. Increasing magnitude increases influence on output.
Output	Output from the PID
Err_1	The Error (PV – SP) from the previous scan
Integral	Integrator. Anti-windup is applied after the output is determined to be within bounds.
PV1, PV2	PV from the previous scan and the scan before that.
ScanTime	Actual scan time (time since previous scan)

### Equations Common to All Algorithms

$$\text{Err} = \text{PV} - \text{SP}$$

$$\text{Span} = (\text{OutHi} - \text{OutLo}) / (\text{InHi} - \text{InLo})$$

$$\text{Output} = \text{Output} + \text{FeedForward} * \text{TuneFF}$$

<sup>2</sup>The following obsolete algorithms support PID loops configured before PAC Project R9.5. For details, see the [Opto 22 KnowledgeBase article KB82058](#)

- Velocity (Type B) Obsolete
- ISA (Obsolete)
- Parallel (Obsolete)
- Interacting (Obsolete)

You can continue to use these obsolete algorithms, but Opto 22 recommends you use the new algorithms when configuring new PID loops.

**Equations Common to ISA, Parallel, and Interacting**

$$\begin{aligned} \text{Integral} &= \text{Integral} + \text{Err} \\ \text{TermP} &= \text{Err} \\ \text{TermI} &= \text{TuneI} * \text{ScanTime} * \text{Integral} \\ \text{TermD} &= (\text{TuneD} / \text{ScanTime}) * ( \text{PV} - \text{PV1} ) \end{aligned}$$

**Velocity (Type C) Algorithm**

$$\Delta\text{TermP} = ( \text{PV} - \text{PV1} )$$

In this part of the formula, you adjust **TuneI**.

$$\Delta\text{TermI} = \text{TuneI} * \text{ScanTime} * \text{Err}$$

In this part of the formula, you adjust **TuneD**.

$$\Delta\text{TermD} = \text{TuneD} / \text{ScanTime} * ( \text{PV} - 2 * \text{PV1} + \text{PV2} )$$

In this part of the formula, you adjust **Gain**.

$$\Delta\text{Output} = \text{Span} * \text{Gain} * ( \Delta\text{TermP} + \Delta\text{TermI} + \Delta\text{TermD} )$$

**ISA (or "Ideal") Algorithm**

$$\text{Output} = \text{Span} * \text{Gain} * ( \text{TermP} + \text{TermI} + \text{TermD} )$$

**Parallel (or "Independent") Algorithm**

$$\text{Output} = \text{Span} * ( \text{Gain} * \text{TermP} + \text{TermI} + \text{TermD} )$$

**Interacting (or "Classic") Algorithm**

$$\text{Output} = \text{Span} * \text{Gain} * ( \text{TermP} + \text{TermI} ) * ( 1 + \text{TermD} )$$

*NOTE: In SNAP PAC Ethernet-based PIDs, the derivative is applied only to the process variable (the input) and not to the setpoint. This means you can change the setpoint without causing spikes in the derivative term. These PIDs also prevent integral windup by back calculating the integral without the derivative term. The feed forward term ("bias") is added before output clamping and has a tuning factor.*

PAC-R  
EB  
SB  
UIO  
EIO

**Steps for Configuring PIDs**

*NOTE: This section applies only to PIDs on SNAP PAC, SNAP Ultimate, and SNAP Ethernet I/O units.*

1. With the configuration file open, right-click the name of the I/O unit the PID will be on. From the pop-up menu, choose Configure.  
The Configure I/O Units dialog box opens.

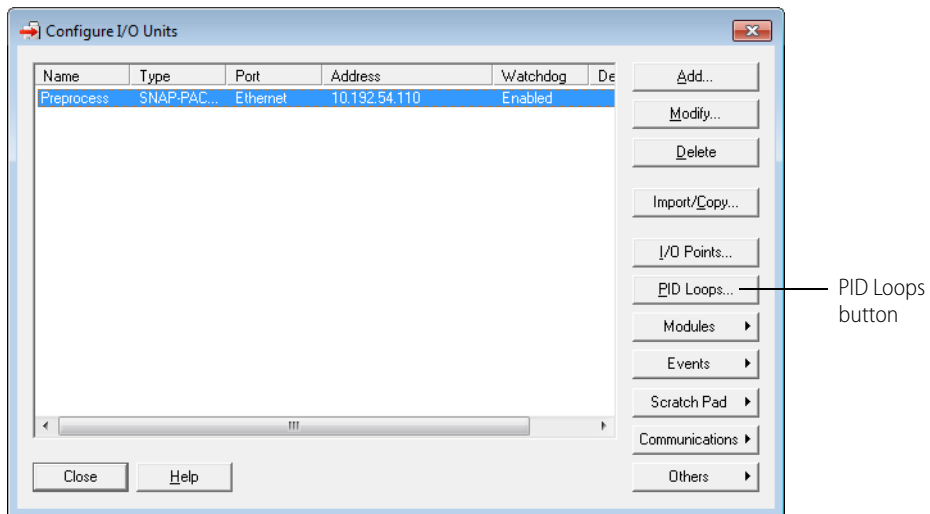

2. Make sure the correct I/O unit is highlighted. Click the PID Loops button.

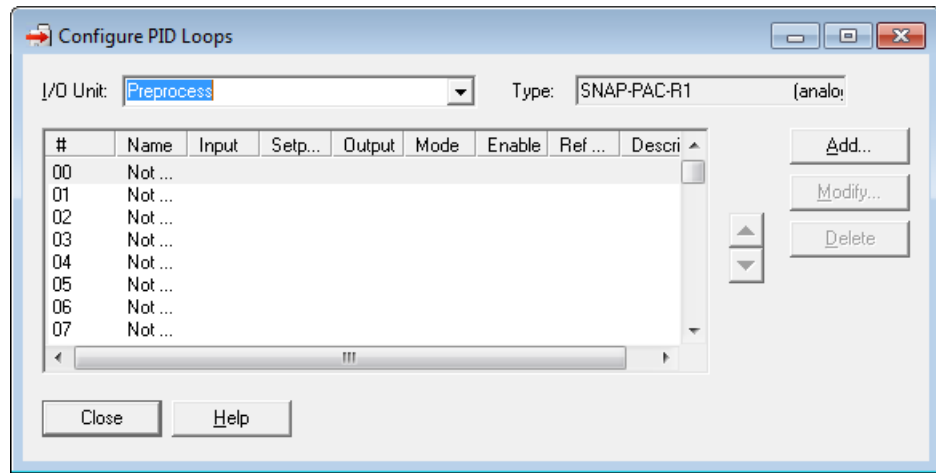

3. Double-click the lowest unused PID number.

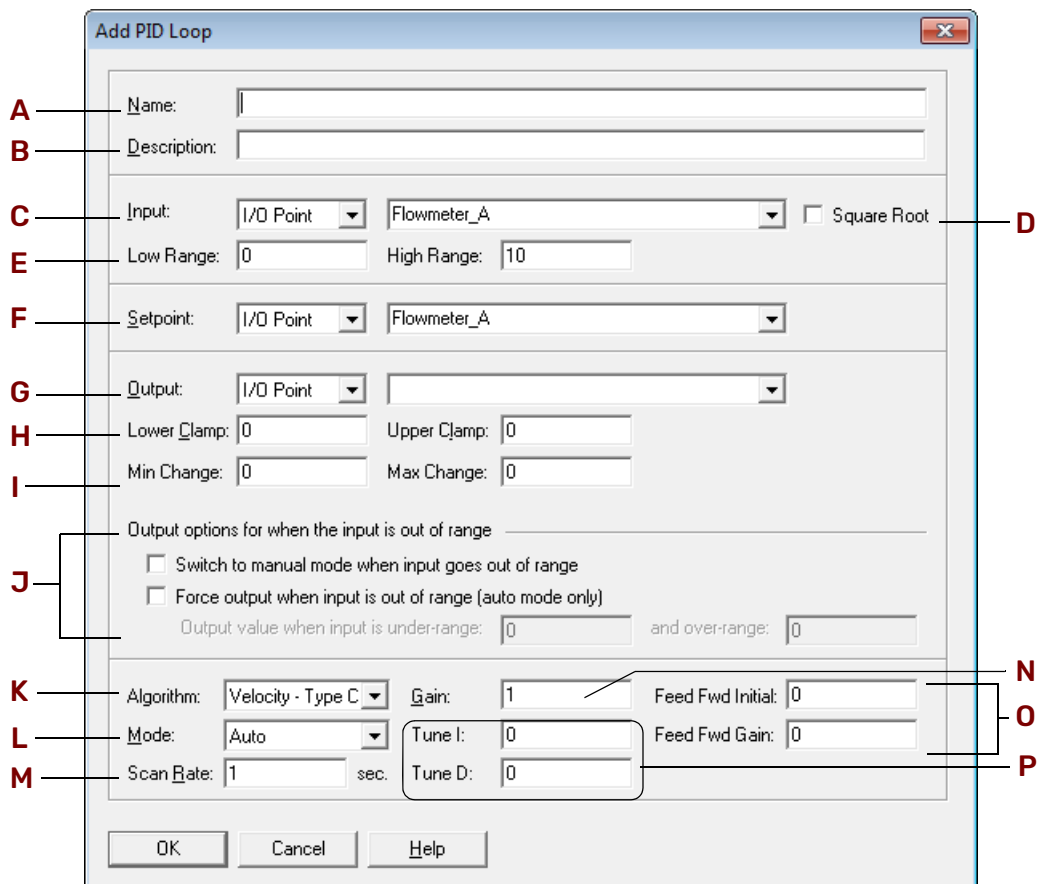

4. Complete the fields as follows:

**A—Name.** Type a unique, descriptive name for the PID.

**B—Description.** (Optional) Enter a description of the PID.

**C—Input.** Select the type of input: I/O Point, Host, or PID Output.

- If the PID's process variable comes from an I/O point on the same unit, select I/O Point. Choose the point from the drop-down list or type a point name to configure a new point.
- If the PID's process variable comes from a PAC Control strategy, select Host. Enter an initial value for the input.
- If the PID's process variable is the output of another PID on this I/O unit (a cascading control loop), select PID Output. Choose the PID from the drop-down list.

**D—Square Root.** (Optional) If you chose I/O Point or PID for step C, check this box if the error should be calculated based on the square root of the process variable (applies to flow control systems where volumetric flow is proportional to the square root of a signal from a flow transducer).

**E—Low/High Range.** Set the valid range of the process variable by entering the low range and the high range. (See J for optional responses to out-of-range input.)

**F—Setpoint.** Choose the source for the setpoint: I/O Point, Host, or PID Output.

- To control the setpoint using a device such as a potentiometer, select I/O Point; choose an I/O point from the drop-down list or type a new point name.
- To control the setpoint using PAC Control or PAC Display, select Host and enter an initial value.
- If another PID loop will control the setpoint, select PID Output and choose the PID from the drop-down list.

**G—Output.** Choose the destination for the PID output: I/O Point or Host. (To use the output for controlling the setpoint or input of another PID, choose Host.)

**H—Lower/Upper Clamp.** Enter upper and lower clamp values to prevent the output from exceeding a desirable range. These values should equal the range of the output point, if used. Or choose values to make sure that the output device doesn't shut off (for example, keeping a circulation pump running regardless of the PID output) or that the output never reaches a destructively high setting (for example, keeping a motor below maximum).

**I—Min/Max Range.** (Optional) Enter minimum and maximum change values. The output won't respond until the minimum change is reached (for example, you may not want a heater to turn on to correct a 1 degree error). Maximum change prevents too drastic a change in output (for example, you could limit the increase in a pump's output to prevent pipe breakage). The default for both minimum and maximum is zero, which disables the feature.

**J—Output Options.** Choose how the PID should respond if the input goes out of range. If no boxes are checked, the PID will freeze output at the current value. To have PAC Control logic or an operator respond, check Switch to manual mode. To force the output to a specific value, check Force output and type the output values. *NOTE: If both boxes are checked (forced output and manual mode), the output will be forced and the PID put into manual mode; but if the PID is already in manual mode, the output will not be forced.*

**K—Algorithm.** Choose algorithm: Velocity-Type C, ISA, Parallel, or Interacting. See [page 79](#) for more information.

**L—Mode.** Choose Mode. Auto activates the PID. Manual requires that PAC Control logic or an operator control the PID output.

**M—Scan Rate.** Enter a scan rate to determine how often the input is scanned and the controller output is calculated. Minimum value is 0.001 (1 millisecond). Scan time should be greater than system lag (the time it takes for the controller output to have a measurable effect on the system). Also consider other PIDs and tasks on the I/O unit competing for processing power.

**N—Gain.** Enter a positive or negative value for Gain. Heating systems usually require a negative value and cooling systems a positive value. *NOTE: Gain is usually refined during the tuning process.*

**O—Fd Fwd Initial and Fd Fwd Gain.** (Optional) Enter Feed Forward Initial and Feed Forward Gain values if you need to offset the controller output in your application. These values are constants that are multiplied and added to the controller output; often they are not used in PIDs.

**P—Tune I, Tune D.** (Optional) Enter Integral and Derivative settings if you know the desirable settings. However, Integral and Derivative are not essential to basic configuration and are better determined in the tuning process.

- Click OK.  
The new PID appears in the list.

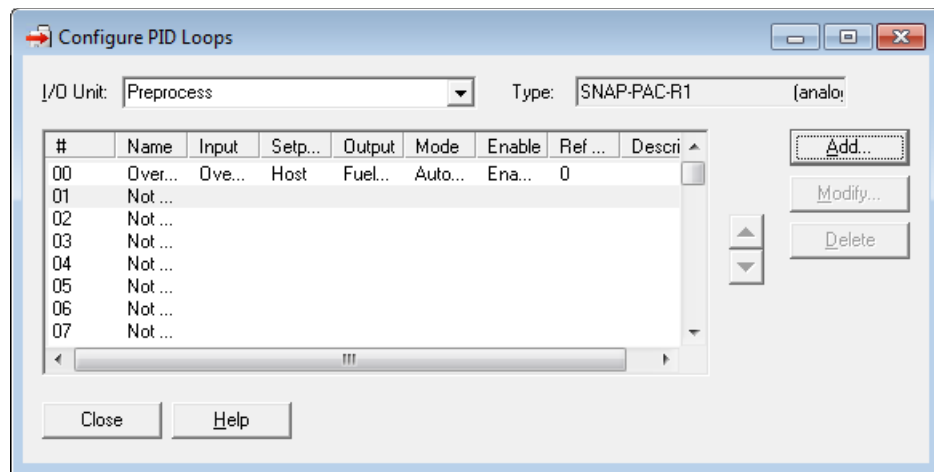

- When you have finished configuring PIDs, click Close.  
PIDs appear in the configuration tree under the I/O unit.

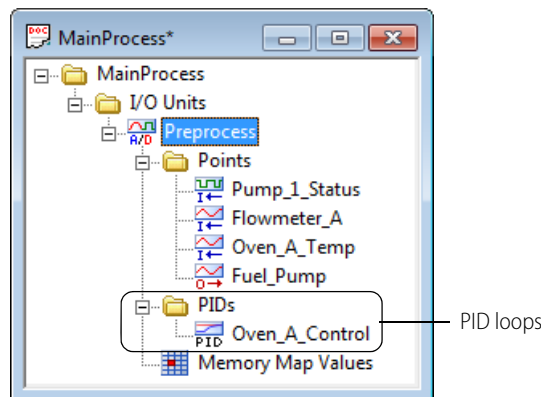

## SENDING CONFIGURATION DATA TO THE I/O UNIT

PAC-R  
EB  
SB  
UIO  
EIO  
SIO  
E1  
E2

After you have configured I/O units and set up optional functions such as security, email, and SNMP from Chapter 3, you must load the configuration file onto the I/O unit.

You can load the configuration file into RAM only, or you can save it to flash memory at the same time. If you don't save to flash, the configuration is lost if the I/O unit is turned off. When you save to flash, the new

## SENDING CONFIGURATION DATA TO THE I/O UNIT

configuration overwrites any configuration already in the flash memory. Note that for some functions, you must save to flash and restart the I/O unit for the configuration to take effect.

1. With the configuration file open, click Tools > Send Configuration to I/O Unit.  
The Send Configuration dialog box appears.

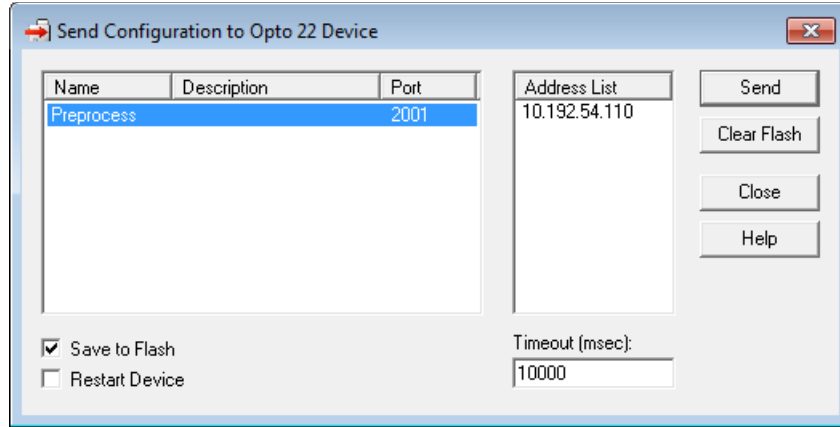

The list on the left shows all the I/O units in this configuration file. (In the case of an SB I/O unit, there is only one.) When you click a unit, the Address List shows the serial address or IP addresses for all I/O units associated with the highlighted unit. This is the address list you set up in the Add I/O Unit dialog box, shown on [page 45](#).

2. Highlight the I/O unit configuration(s) you want to send.
3. Highlight the IP addresses to receive the I/O unit configuration.  
If you don't highlight any addresses, the configuration will be sent to the entire list.

*NOTE: If you highlighted more than one unit configuration, each unit configuration will automatically be sent to all the IP addresses associated with it.*

4. If necessary, change the Timeout field.  
The timeout field shows how long, in milliseconds, PAC Manager will try to communicate with the I/O unit before returning a timeout error.
5. To save the configuration file to flash memory as well as to RAM, check Save to Flash. (If you don't save to flash, the configuration is lost if the I/O unit is turned off.) To also restart the unit, check Restart Device.

**IMPORTANT:** For the following configurations, you must save to flash and restart the unit in order for configuration to take effect:

*Changes in TCP port for serial modules*

*SNMP configuration*

*Email configuration*

*PPP configuration*

*Data logging interval*

*NOTE: PID loops are saved, but PID **module** settings are not saved when you cycle power to the I/O unit and the PID module. PID module settings cannot be saved to the I/O unit's flash memory. If you turn off power to these components, you will need to reenter PID module settings using either PAC Manager or the OptoENET PID Module Tuner software.*

6. Click Send.  
The configuration data is sent to the I/O units whose IP addresses you chose.

PAC-R  
EB  
SB  
UIO  
EIO  
SIO

## Using PAC Manager to Clear Flash Memory

You can also use PAC Manager to clear configuration data from flash memory in one or more I/O units. (This action does not affect brain or controller firmware, strategy files, or files from the I/O unit's file system that may be stored to flash.)

1. With the configuration file open, click Tools > Send Configuration to I/O Unit.
2. In the Send Configuration dialog box, highlight the I/O unit configuration and addresses for the I/O units you want to clear.
3. Click Clear Flash.  
Configuration data in flash memory is cleared.

## USING I/O POINT FEATURES

PAC-R  
EB  
SB  
UIO  
EIO  
SIO  
E1  
E2

The I/O point features available on I/O units depend on the combined capabilities of the I/O processor (brain, brain board, or on-the-rack controller), the module, and in some cases, the protocol used. See [page 9](#) to determine which features are available for the processor you are using. Note that some features (such as pulsing and totalizing) can be configured in PAC Manager but are currently available for use only through PAC Control. For details, see the [PAC Control User's Guide](#) (form 1700).

The following table defines the features. Some have referenced pages for more information.

Feature	Description	See
<b>States</b>	(digital input and output)—A digital point is either on or off. You can read the current state of a digital input or write an on/off state to a digital output.	<a href="#">page 87</a>
<b>Latches</b>	(digital input)—When the value of a digital input point changes from off to on, an on-latch is automatically set. While the value of the point may return to off, the on-latch remains set, as a record of the change, until you clear it. Similarly, an off-latch is set when the value of a digital point changes from on to off, and it remains set until cleared.	<a href="#">page 87</a>
<b>Counters</b>	(digital input)—A counter keeps track of the number of times a digital input changes from off to on. The count accumulates until it reaches the maximum count available in the I/O unit or until you reset the counter to zero. For example, to count the number of widgets produced per shift, you would clear the counter at the start of each shift and read it at the end of each shift. For points on a 4-channel module, the speed of the counter depends upon the brain or controller's capabilities and the speed of the module used. For points on a high-density module, counting is done in the module.	<a href="#">page 87</a>
<b>Quadrature counters</b>	(digital input)—A quadrature counter requires a SNAP quadrature input module, which is attached to the encoder device. The module sends a pulse to the I/O unit upon each change in quadrature state, and the I/O unit counts the pulses and keeps track of the direction and rotation.	<a href="#">page 88</a>
<b>Frequency measurement</b>	(digital input)—Frequency is the speed with which a digital point changes state and is usually measured in counts per second. For example, reading the frequency can help you determine the speed of rotating machinery.	*
<b>Period measurement</b>	(digital input)—Period refers to the elapsed time for a complete on-off-on transition on a digital point. Measurement starts on the first transition (either off-to-on or on-to-off) and stops on the next transition of the same type.	*
<b>Time-proportional output (TPO)</b>	(digital output)—Time-proportional output varies the duty cycle and the percentage of on time within that cycle. TPO is often combined with a PID loop and used to control the output, for example in a heater or oven.	*
<b>Pulse duration measurement</b>	(digital input)—A pulse is a brief on (or off) state, usually repeated at a specific interval. The brain can measure the first pulse, that is, the amount of time the input stays on (or stays off).	N/A

Feature	Description	See
<b>Pulse and square wave generation</b>	(digital output)—A pulse turns a digital output on (or off) briefly, either once or for a specified number of times at a specified interval. A digital square wave is a specific pattern of on and off states, repeated continuously.	*
<b>Totalization</b>	(digital and analog input)—For a <b>digital input</b> , a totalizer accumulates the total amount of time that a digital input is on (or off). The on-time totalizer shows how long the point has been on; the off-time totalizer shows how long the point has been off. Totalizers are often used to determine maintenance or use schedules. For an <b>analog input</b> , a totalizer accumulates readings by sampling the input point at set intervals and storing the total value, for example to determine total flow based on a varying flow rate signal.	*
<b>Watchdog</b>	(digital and analog points)—A watchdog monitors communication on the OptoMMP port (port 2001, unless you have changed it). If nothing accesses the port for the length of time set in the watchdog, the I/O unit automatically sets designated digital and analog I/O points to the values you have determined. A watchdog helps make sure that a communication failure doesn't result in disaster. If communication fails between the host and the I/O unit controlling a process, the watchdog makes sure the process is automatically brought to a safe state. For example, a valve could automatically close to avoid completely emptying a tank. <i>IMPORTANT:</i> A strategy running on a SNAP PAC R-series controller accesses the points on its own rack directly, not through the OptoMMP port. Consequently, reads and writes to the local I/O are not seen by the watchdog.	page 88
<b>Scaling</b>	(analog input and output)—Analog input and output points can be scaled as needed. For example, you can scale a -5 V to +5 V input point to reflect 0% to 100%	page 88
<b>Minimum and maximum values</b>	(analog input)—Minimum and maximum values are sometimes called peaks and valleys. You can read these values at any time, for example, to record minimum and maximum temperatures. You can also reset min/max values. For example, if you want to record the maximum temperature at point 2 in each 24-hour period, you must reset the values after they are read each day.	page 89
<b>Thermocouple linearization</b>	(analog input)—The I/O unit automatically converts the thermocouple junction's millivolt values into temperature values, so you don't have to. Choose the appropriate module and make sure you configure the point as the correct thermocouple type (E, K, etc.) for your purpose.	--
<b>Offset and gain</b>	(analog input)—Offset and gain calculations are used to calibrate analog points. If a -50 mV to +50 mV input receives signals that are slightly off (for example, not exactly -50 mV at the lowest point), the offset and gain can be calculated so that values will appear accurately when read.	page 89
<b>Clamping</b>	(analog output)—Clamping limits values that can be sent to analog output points so they do not go above or below a specific value. For example, if you are using a 0–10 VDC output module, but the device attached to one of its points can handle a maximum of only 5 VDC, you can set an upper clamp of 5 VDC for that point. The values for upper and lower clamp are set in engineering units.	page 90
<b>Ramping</b>	(analog output)—Some devices attached to analog outputs should not be abruptly stepped up or down, because a sudden change might damage the equipment or cause other problems. Instead, you can gradually ramp the device up or down to the desired value.	*
<b>PID loop control</b>	(analog points)—Proportional integral derivative (PID) loops are used to drive an input toward a particular value (the setpoint) and keep the input very close to that value by controlling an output. PID loops are often used in temperature control.	page 78
<b>Average filter weight</b>	(analog inputs)—A filter weight smooths analog input signals that are erratic or change suddenly.	page 90

\* Requires PAC Control and a SNAP PAC controller for use. For details, see the [PAC Control User's Guide](#) (form 1700).



Some I/O point features are discussed in the following sections.

PAC-R  
EB  
SB  
UIO  
EIO  
SIO  
E1  
G4EB2

### States (Digital Points)

You can read the ON or OFF state of a digital input point or write to a digital output point to turn it on or off. This feature is automatic and needs no configuration.

*NOTE: You can configure E1 brain boards this same way if you have E1/E2 firmware R1.2a (and higher) and PAC Project R9.5000 (and higher). Also, if a SNAP PAC controller communicates with the E1, the controller must have PAC firmware R9.5a (or higher) to use this simplified configuration method.*

*If you are not using these firmware and software versions, then each point on the E1 unit is treated like the first point on a SNAP module; that is, only the first of every four points contains data. To reconfigure existing E1s, see [I/O Configuration for E1 and E2 Brain Boards \(form 1576\)](#).*

PAC-R  
EB  
SB  
UIO  
EIO  
SIO  
E1  
G4EB2

### Latches (Digital Points)

**SNAP and G4EB2**—Latching is available on both 4-channel and high-density digital points. It is automatic and needs no configuration. Using memory map values, you can read the on-latch or off-latch state of a digital point, and you can clear latches.

**E1**—Latching is available on all modules used with the E1. Note that latching is different on an E1 depending on the protocol used with the brain board. When the E1 is used with the Optomux protocol, only one latch is available and you must configure it to be an on-to-off latch or an off-to-on latch. When you use an E1 with PAC Control or OptoMMP, however, both types of latches are automatically available for each point, and no configuration is required.

To read and/or clear latches, use PAC Control digital point commands.

PAC-R  
EB  
SB  
UIO  
EIO  
SIO  
E1  
G4EB2

### Counters (Digital Points)

**SNAP**—Any SNAP digital input can be used as a counter. Note the differences in counting between 4-channel and high-density digital modules:

	SNAP 4-channel digital counters	SNAP high-density digital counters
Processor compatibility	SNAP-PAC-R1 (-B, -FM, -W) SNAP-PAC-EB1 (-FM, -W) SNAP-PAC-SB1 SNAP-B3000-ENET SNAP-ENET-RTC SNAP-UP1-ADS	SNAP-PAC-R1 (-B, -FM, -W) SNAP-PAC-R2 (-FM, -W) SNAP-PAC-EB1 (-FM, -W) SNAP-PAC-EB2 (-FM, -W) SNAP-PAC-SB1 SNAP-PAC-SB2 SNAP-B3000-ENET SNAP-ENET-RTC SNAP-ENET-S64 SNAP-UP1-ADS SNAP-UP1-M64
Counting is done on...	...the brain	...the module
Counting speed	High speed (depends on speed of module; modules available up to 20 KHz)	Low speed (up to 50 Hz)
Configuration and Use	<ul style="list-style-type: none"> <li>Each point to be used as a counter must be configured.</li> <li>Counters start as soon as configured.</li> <li>Counters can be Started, Stopped, Read, and Read &amp; Cleared.</li> </ul>	<ul style="list-style-type: none"> <li>Configure points only if using PAC Control.</li> <li>Counters are always counting.</li> <li>Counters can be Read or Read &amp; Cleared.</li> <li>Counters cannot be Started or Stopped.</li> </ul>

**G4EB2**—Any digital input can be used as a counter. Counters must be configured. They start as soon as they are configured and can be Started, Stopped, Read, and Read & Cleared.

**E1**—Any digital input can be used as a counter. Use PAC Control digital point commands to work with counters.

PAC-R  
EB  
SB  
UIO  
EIO  
E10

### Quadrature Counters (Digital Inputs)

I/O units with the following I/O processors support quadrature counters for quadrature encoder devices:

- SNAP-PAC-R1
- SNAP-PAC-R1-B
- SNAP-PAC-EB1
- SNAP-PAC-SB1
- SNAP-UP1-ADS
- SNAP-B3000-ENET
- SNAP-ENET-RTC

A quadrature counter requires a SNAP quadrature input module (SNAP-IDC5Q), which is attached to the encoder device. The module sends a pulse to the processor upon each change in quadrature state, and the processor counts the pulses and keeps track of the direction and rotation. For each axis, the counter counts up if Phase A leads Phase B; it counts down if Phase A lags behind Phase B. Each axis can have counts from 0 to 2,147,483,647.

If your encoder device has an index feature, you can use two separate digital input points as indexes, one for each axis. The index automatically resets the count, and it shows what the count was when the index was triggered. Counts are sometimes lost, due to noise or encoder problems, for example; with the index, you can see whether the count varies too much.

PAC-R  
EB  
SB  
UIO  
EIO  
SIO  
E1  
E2  
G4EB2

### Watchdog (Digital and Analog Points)

To configure a watchdog, set the watchdog when configuring the *I/O unit*. Then when you configure a digital or analog output point, you can choose the status or value the point should be set to if the watchdog timer expires. Some older I/O units do not include watchdogs on high-density digital points. See the comparison chart for details.

*About E1 and E2 brain boards: You can configure E1s and E2s like any other I/O unit if you have E1/E2 firmware R1.2a (and higher) and PAC Project 9.5000 (and higher). Also, if a SNAP PAC controller communicates with the E1 or E2, the controller must have PAC firmware R9.5a (or higher) to use this simplified configuration method. If you are not using these firmware and software versions (or if you prefer to use the previous method to reconfigure existing E1s or E2s), see [I/O Configuration for E1 and E2 Brain Boards \(form 1576\)](#).*

PAC-R  
EB  
SB  
UIO  
EIO  
SIO  
E2

### Scaling (Analog Points)

You can scale analog input or output points to match your needs. For example, you can scale a -5 V to +5 V input point to reflect 0% to 100%. Point types may be unipolar or bipolar.

#### Examples of Unipolar Points

- 4–20 mA analog output
- 0–10 A RMS analog input

#### Examples of Bipolar Points

- 25 mV to +25 mV analog input
- 10 to +10 VDC analog output

Unipolar and bipolar points are scaled in the same way, with the lowest reading reflecting the low scale and the highest reading reflecting the high scale. Here are two examples:

	Unipolar Input Point		Bipolar Input Point		
	Low scale	High scale	Low scale	High scale	
<b>Actual reading</b>	0 mA	20 mA	-5 V	0 V	+5 V
<b>Scaled for percentage</b>	0%	100%	0%	50%	100%
<b>Scaled for counts*</b>	0	+25,000	-25,000	0	+25,000

\*Counts for input points always range -25,000 to +25,000.

	Unipolar Output Point		Bipolar Output Point		
	Low scale	High scale	Low scale	High scale	
<b>Actual reading</b>	4 mA	20 mA	-10 VDC	0 VDC	+10 VDC
<b>Scaled for percentage</b>	0%	100%	0%	50%	100%
<b>Scaled for counts*</b>	0	4,095	0	2,047.5	4,095

\*Counts for output points always range 0–4,095.

*NOTE: With PAC firmware version 8.1 and higher, you can also use inverted scaling. For example:*

0 mA            20 mA  
742 fpm        -27 fpm

*NOTE: You can configure E2 brain boards like any other I/O unit if you have E1/E2 firmware R1.2a (and higher) and PAC Project R9.5000 (and higher). Also, if a SNAP PAC controller communicates with the E2, the controller must have PAC firmware R9.5a (or higher) to use this simplified configuration method.*

*If you are not using these firmware and software versions (or if you prefer to use the previous method to reconfigure existing E2s), see [I/O Configuration for E1 and E2 Brain Boards](#) (form 1576).*

PAC-R  
EB  
SB  
UIO  
EIO  
SIO  
E2

### Minimum and Maximum Values (Analog Points)

Starting with the introduction of SNAP-B3000-ENET, all SNAP PAC brains (including SBs), SNAP Ethernet I/O units, and E2 brain boards automatically keep track of minimum and maximum values on analog points. You can read and clear these values using PAC Manager's Inspect mode.

PAC-R  
EB  
SB  
UIO  
EIO  
SIO  
E2

### Offset and Gain (Analog Points)

Starting with the introduction of SNAP-B3000-ENET, all SNAP PAC brains (including SBs), SNAP Ethernet I/O units, and E2 brain boards can automatically calculate offset and gain for analog input points. If a -50 mV to +50 mV input receives signals that are slightly off (for example, not exactly -50 mV at the lowest point), the offset and gain can be calculated so that values appear accurately when read.

Offset and gain values affect engineering units (EU). For a temperature input, engineering units are in degrees C or F, depending on how the I/O unit is configured.

**IMPORTANT:** *To calibrate the point, the I/O unit must be turned on and attached to the network, and you must have access to the I/O unit in order to use the calibrator. For points on a SNAP PAC SB-series brain, connect directly via serial or through the controller via Ethernet. (See [page 39](#) for details.)*

*Save the configuration to flash so that it is not lost when power is turned off. Since each calibration is for a specific point on a specific I/O unit, the result cannot be saved to the configuration file and cannot be sent to any other I/O unit.*

First, calculate offset, and then calculate gain. The offset must be calculated at the signal corresponding to zero engineering units (EU), and the gain must be calculated at the signal corresponding to the point's maximum input range value (or, for inverted scaling, the point's minimum input range value—in inverted scaling, the lower scaled value is greater than the upper scaled value).

For details, see [“Calibrating Offset and Gain Using the Default Method” on page 196](#).

If you don't have access to a calibrator, or if the point uses inverted scaling and your device has PAC firmware R9.5b or lower, see [“Calculating Offset and Gain Using the Two-Point Method” on page 198](#).

If you are using **Modbus/TCP**, you will need to calculate the offset and gain yourself. Then you can write offset and gain values to the I/O unit. For details, see [page 58](#) [Calibrating Offset and Gain](#).

PAC-R  
EB  
SB  
UIO  
EIO  
SIO

### Clamping (Analog Points)

SNAP Ethernet-based I/O units with analog capability and SNAP PAC SB brains can clamp values sent to analog output points so they do not go above or below a specific limit. For example, if you are using a 0–10 VDC output module, but the device attached to one of its points can handle a maximum of only 5 VDC, you can set an upper clamp of 5 VDC for that point. The values for upper and lower clamp are set in engineering units. (See [“Configuring I/O Modules, Points, and Features” on page 178](#).)

PAC-R  
EB  
SB  
UIO  
EIO  
SIO

### Average Filter Weight (Analog Points)

SNAP PAC Ethernet-based I/O units and SNAP PAC SB brains can use a filter weight to smooth analog input signals that are erratic or change suddenly. The formula used for filtering is  $Y = (X - Y)/W + Y$ , where Y is the filtered value, X is the new unfiltered value, and W is the filter weight.

This graph shows the effect of filter weights (W) 2, 5, and 10 on a step input signal:

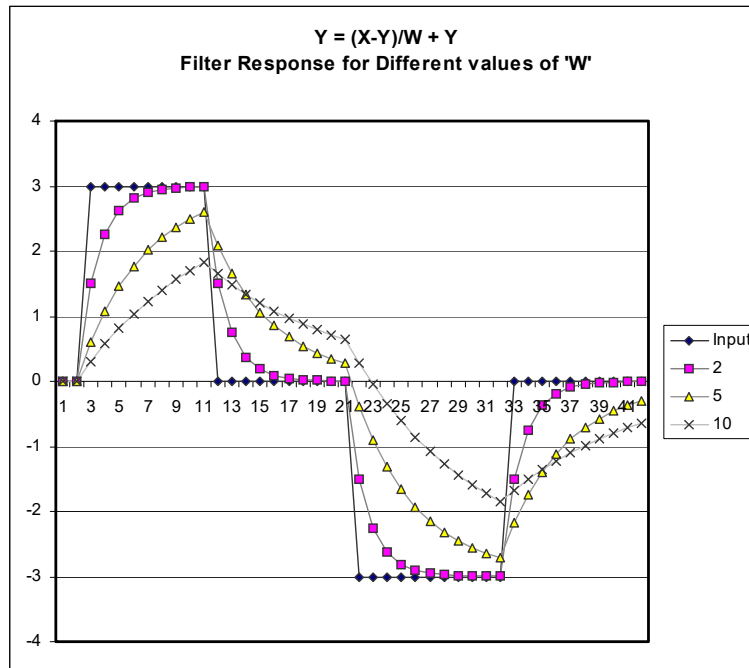

A filter weight of zero turns off the calculation. Values less than or equal to 0.5 are changed to zero, since those values would cause an unstable signal.

Filtering is applied to values that are in engineering units, including minimum and maximum values. Filtering does not apply to values that are in counts. Set filter weight when configuring the analog point. Use the PAC Manager Inspect window to set filter weight (see [“Configuring I/O Modules, Points, and Features” on page 178](#)). If you are using PAC Control, you can also set filter weight in your control strategy using the command Set Analog Filter Weight.



# 3: Configuring Optional Functions

## INTRODUCTION

Chapter 2 showed you how to configure I/O unit points and features. This chapter includes instructions for setting up the following optional functions:

Setting up network security (wired network)	<a href="#">page 94</a>
Logging data	<a href="#">page 103</a>
Sending event messages via email, SNMP, a stream packet, or a serial module	<a href="#">page 108</a>
Using SNMP for communicating with enterprise management systems	<a href="#">page 112</a>
Configuring DNS Servers	<a href="#">page 115</a>
Sending email	<a href="#">page 116</a>
Using the Scratch Pad area for peer-to-peer data sharing	<a href="#">page 118</a>
Streaming data	<a href="#">page 120</a>
Mirroring I/O point data	<a href="#">page 123</a>
Copying memory map data	<a href="#">page 125</a>
Configuring Modbus options	<a href="#">page 128</a>
Setting system date and time	<a href="#">page 132</a>
Communicating serially with devices attached directly to a controller	<a href="#">page 134</a>
Using PPP for communicating via modem with the device	<a href="#">page 139</a>

In most cases, you use the same configuration file in PAC Manager to set up optional functions as you did to configure I/O units, so the complete configuration information can be uploaded to I/O units all at once.

## SETTING UP NETWORK SECURITY (WIRED NETWORK)

For network security on a wireless LAN, see [“Configuring Wireless LAN Communication \(Wired+Wireless Models Only\)”](#) on page 35.

PAC-S  
PAC-R  
EB  
UIO  
EIO  
SIO  
E1  
E2

You can use PAC Manager to set up security on a wired network for an Opto 22 SNAP Ethernet-based device. You can limit access to specific computers or other devices on the network. You can also limit access to specific protocols used with the Opto 22 device, such as SNMP (below). You can require a password for using FTP (see [page 95](#)). In addition, you can protect a PAC Control strategy so that it runs without possibility of interference from a host ([page 97](#)).

### Limiting Access to Specific Computers

You can limit access to the controller or I/O unit based on the IP address of the computer or other host device attempting to communicate with it. You specify the IP addresses that may access the controller or I/O unit. Anyone on a computer or other host device with an acceptable IP address has access.

Work with your network administrator to make sure you are specifying the correct IP addresses. See [“Configuring Ethernet Security on an I/O Unit”](#) on page 98 or [“Configuring Ethernet Security on a Standalone Controller”](#) on page 101 for instructions.

### Limiting Access to Specific Protocols

You can also limit access to specific protocols the controller or I/O unit uses. These protocols can travel simultaneously over the Ethernet/TCP/IP link and set up sessions, or ports, on the device:

- File transfer protocol (FTP), used for exchanging files between the device and a computer (applies to SNAP PAC R-series, S-series, and SoftPAC and SNAP Ultimate I/O units only)
- Modbus/TCP protocol, used by Modbus/TCP software and hardware
- OptoMMP, the IEEE 1394-based memory map protocol, used by most other tools for interfacing with the SNAP device
- Simple network management protocol (SNMP), used to communicate with SNMP-based enterprise management software (SNAP PAC, SNAP Ultimate, and SNAP Ethernet I/O units only)

For security purposes, you can hide or disable one or more of the protocols by changing the port number from its default. The following table shows these default ports.

*NOTE: If you change any port number, you must restart the device before the changes will take effect.*

#### Protocols for Default Ports:

Protocol	Used by	Default Port
FTP	PCs for file exchange	21
SNMP	enterprise management system	161
Modbus/TCP	Modbus/TCP software and hardware	502
OptoMMP	PAC Manager and most other tools	2001

**Preventing Access.** For example, suppose you want to prevent any device from accessing a controller using FTP. To do so, you would change the port number for the FTP protocol from the default of 21 to zero. Since zero is an invalid port, no device could access the controller using FTP.

**Limiting Access.** If you wanted to limit FTP access, you could change the port number from 21 to a non-reserved number between 1 and 65,535 (see list of reserved port numbers, below). If you change the number, anyone (or any application) that needs to access the controller using FTP can do so by adding the changed port number to the controller’s IP address. For example, if the controller’s IP address is 10.22.56.3 and



the port number is changed to 85, you would enter the following to access the controller:

```
10.22.56.3:85
```

### Reserved Port Numbers

If you change port numbers, do not use any number in the following list. These numbers are reserved for Opto 22 firmware:

Port	Used by
20	FTP
21	FTP
25	SMTP
67	BootP Server
68	BootP Client
161	SNMP
162	SNMP Traps
502	Modbus/TCP
2001	OptoMMP Host
2002	OptoControl Peer
2003	OptoControl Peer

Port	Used by
2222	EtherNet/IP (UDP for I/O)
22000	Reserved
22001	PAC Control/ioControl Host
22002	PAC Control Background Downloading
22003	Reserved
22004	PAC Control User Chart
22005	PAC Control User Chart
22500–22531	Serial Communication Modules
23567	PAC Controller Redundancy
44818	EtherNet/IP (TCP & UDP Explicit messages)
50000–50999	PAC controller internal use

For more information, see “Configuring Ethernet Security on an I/O Unit” on page 98 or “Configuring Ethernet Security on a Standalone Controller” on page 101.

### Configuring the PAC as an HTTP/HTTPS Server

In addition to working as a client (for example, to send email) SNAP PAC R-series or S-series controllers with PAC firmware R9.5a or higher include a built-in HTTP/HTTPS server and a REST API. The PAC listens for HTTP and HTTPS requests, and then sends I/O point or strategy variable data to the client that requested it. The complete SNAP PAC REST API and instructions to get started are on [developer.opto22.com](http://developer.opto22.com).

To prevent unauthorized access, the HTTP/HTTPS server feature in PAC R-series or S-series controllers is disabled by default. To configure the server in your controller, you enable either HTTPS or HTTP protocol on the controller and configure a listening port for TCP communication.

*IMPORTANT: Opto 22 strongly recommends using **HTTPS** for secure, encrypted access to your controller.*

Use **HTTP** for testing purposes only.

1. In PAC Manager, click Tools > Inspect, or click the Inspect button .
2. In the Inspect Opto 22 Device window, enter the IP address for the R- or S-series controller you want to configure, or select it from the list.
3. Click the Communications button, and then choose Network Security from the pop-up menu.
4. In the WEB SERVER section:
  - a. Change the default value of TCP Listen Port (address 0xFFFF F03A 0014).  
Typically, port 443 is used for HTTPS, and port 80 is used for HTTP.
  - b. Verify the value of HTTPS (address 0xFFFF F03A 007C).
    - For HTTPS, the value should be Enabled.
    - For HTTP, change the value to Disabled.

## SETTING UP NETWORK SECURITY (WIRED NETWORK)

- c. Click Apply to save the changes.

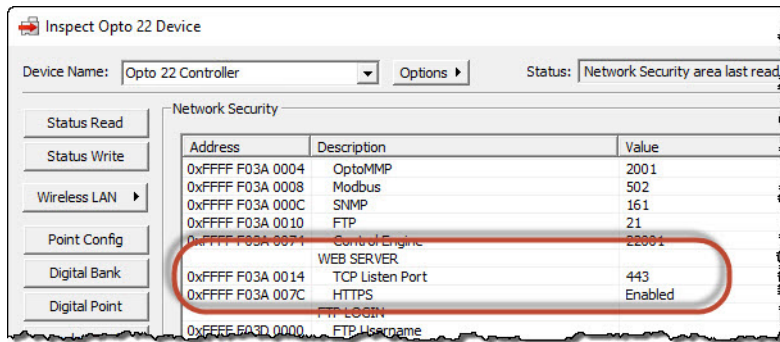

5. To immediately enable the HTTP/HTTPS server feature, reboot the controller so that the changes take effect.

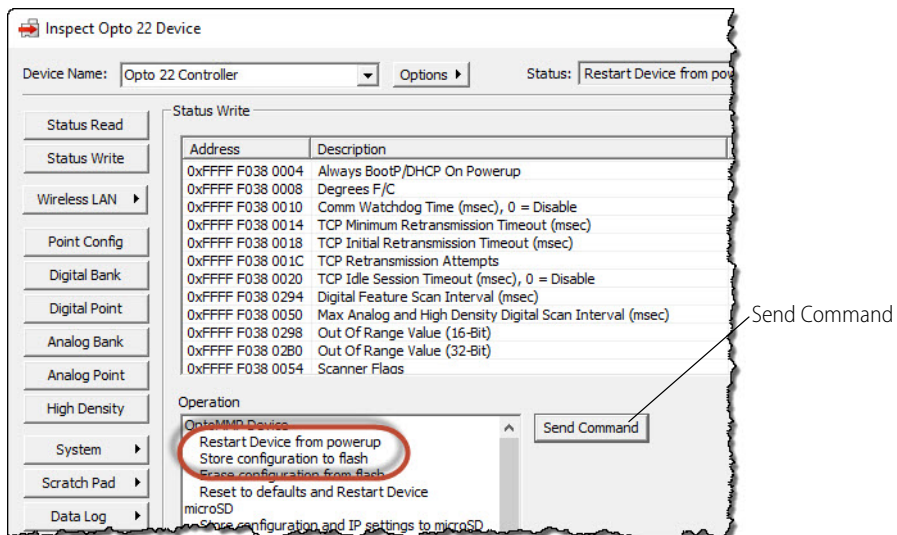

Once you've configured the PAC as a server, the next step is to use a browser (for example, Google Chrome™ or Microsoft Internet Explorer®) to access the PAC and set up the administrator password and API accounts. After that, authorized users can use the SNAP PAC REST API to access data in the controller. For details, see [developer.opto22.com](http://developer.opto22.com).

### Requiring a Password for FTP

You can configure security so that anyone who wants to access the device using FTP is required to enter a username and password. If you are using the Opto iPAC app for iPhone, iPod Touch, or iPad, we strongly recommend you require a password.

See "Configuring Ethernet Security on an I/O Unit" on page 98 or "Configuring Ethernet Security on a Standalone Controller" on page 101 for instructions.

## Protecting a PAC Control Strategy from Interference

You can set up a standalone or on-the-rack controller to run a stable strategy without the possibility of interference from a host. This means that no one can alter or stop the strategy using PAC Control or PAC Terminal; but it also means that PAC Display cannot communicate with the control engine.

To protect a PAC Control strategy from interference, finalize the strategy, download it, save it to flash memory, and then set the autorun flag. (For the steps, see the *PAC Control User's Guide*, form 1700.)

Then, follow the steps in the next section to change the Control Engine port number from the default of 22001 to zero, and save that setting to flash as well. The strategy will automatically run when power is turned on, but a host cannot communicate with it.

If you need to change the Control Engine port number back to 22001, you can do so in PAC Manager, because PAC Manager uses the OptoMMP protocol to communicate with the controller.

### Turning Off EtherNet/IP

If you are not using the EtherNet/IP protocol on a SNAP PAC device, you can turn the protocol off. Note that you must restart the device after this change.

Since this procedure sends the configuration directly to the device, the device must be on the same network as your computer.

1. In the PAC Manager main window, click the Inspect button .

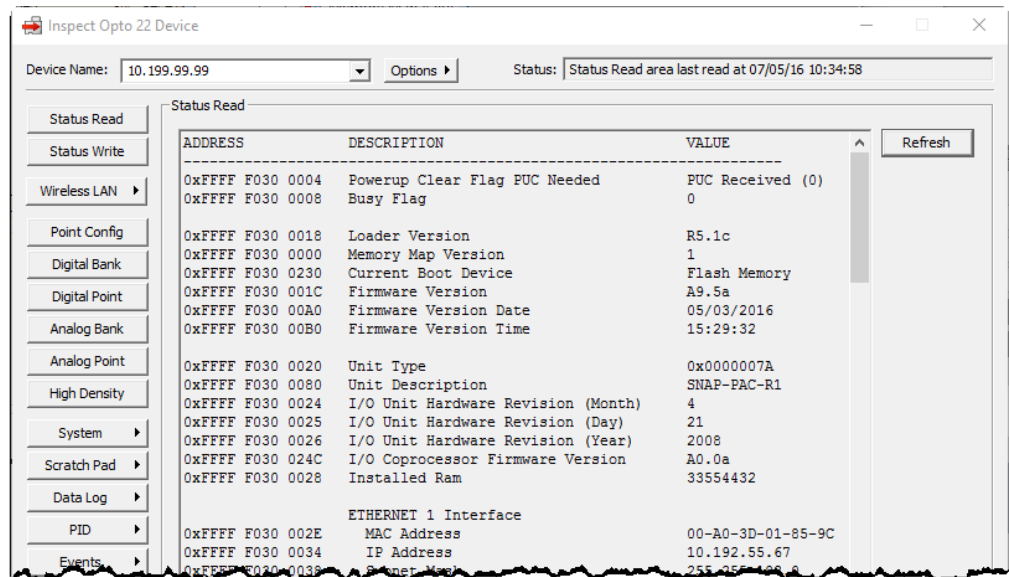

2. In the Device Name field, type the name or IP address of the controller (or choose it from the drop-down list).

## SETTING UP NETWORK SECURITY (WIRED NETWORK)

3. Click Communications and choose Network Security from the submenu. Scroll down till you see ETHERNET/IP.

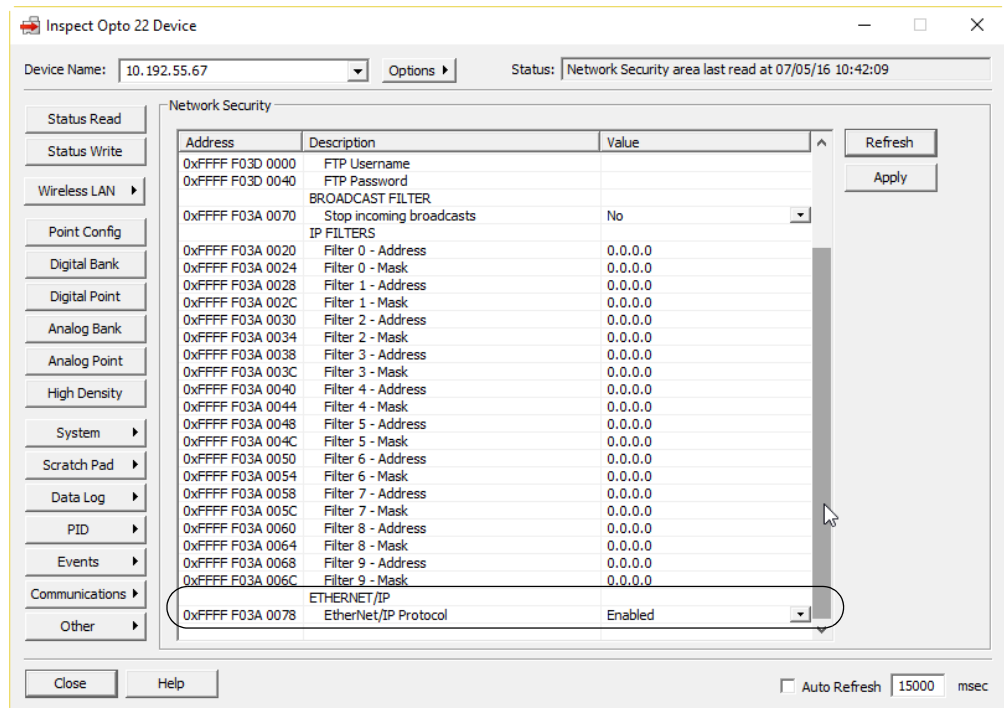

4. In the Value column, click the down arrow and choose Disabled. To enable EtherNet/IP again, choose Enabled.
5. Click Apply to send the configuration change to the device.
6. Click Status Write. In the Operations Commands section, highlight Store configuration to flash. Click Send Command.
7. In the same section, highlight Restart Device from powerup. Click Send Command. The change is stored to flash memory and the device restarts.

PAC-R  
EB  
UIO  
EIO  
SIO  
E1  
E2

### Configuring Ethernet Security on an I/O Unit

Use these steps for an Ethernet-based I/O unit on a wired network. For security on a wireless LAN, see [page 35](#). For a SNAP PAC S-series standalone controller, use the steps on [page 101](#).

1. In PAC Manager, click the Open button  (or in the menu bar, click File > Open).

- In the Open Tag Database dialog box, navigate to the configuration file and double-click it to open it.

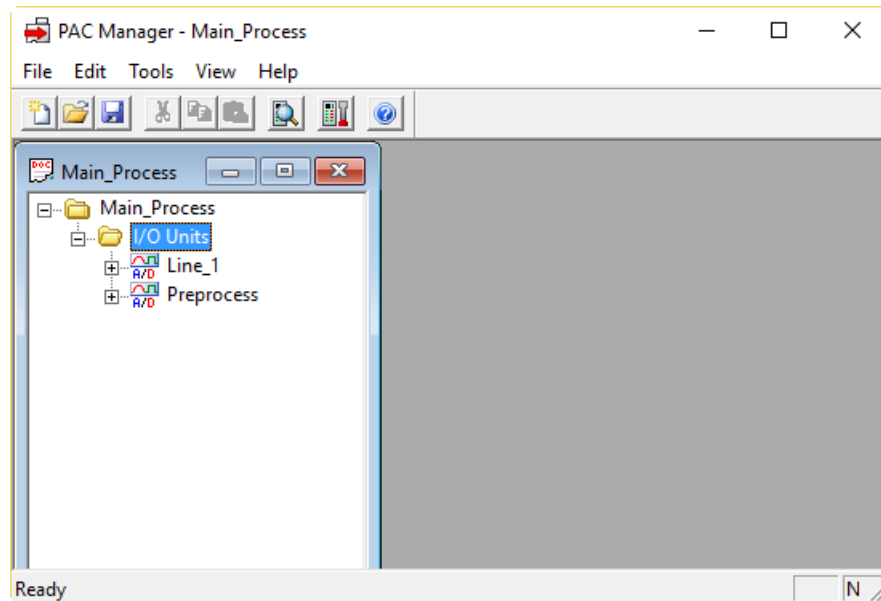

- In the configuration tree, right-click the name of the I/O unit on which you want to set up security and choose Configure from the pop-up menu.

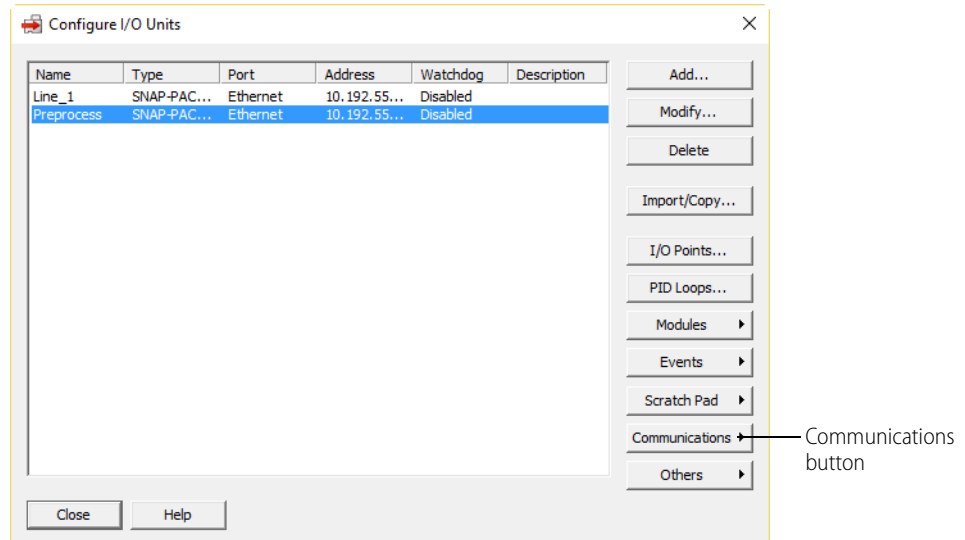

- Click the Communications button and choose Network Security from the pop-up menu.

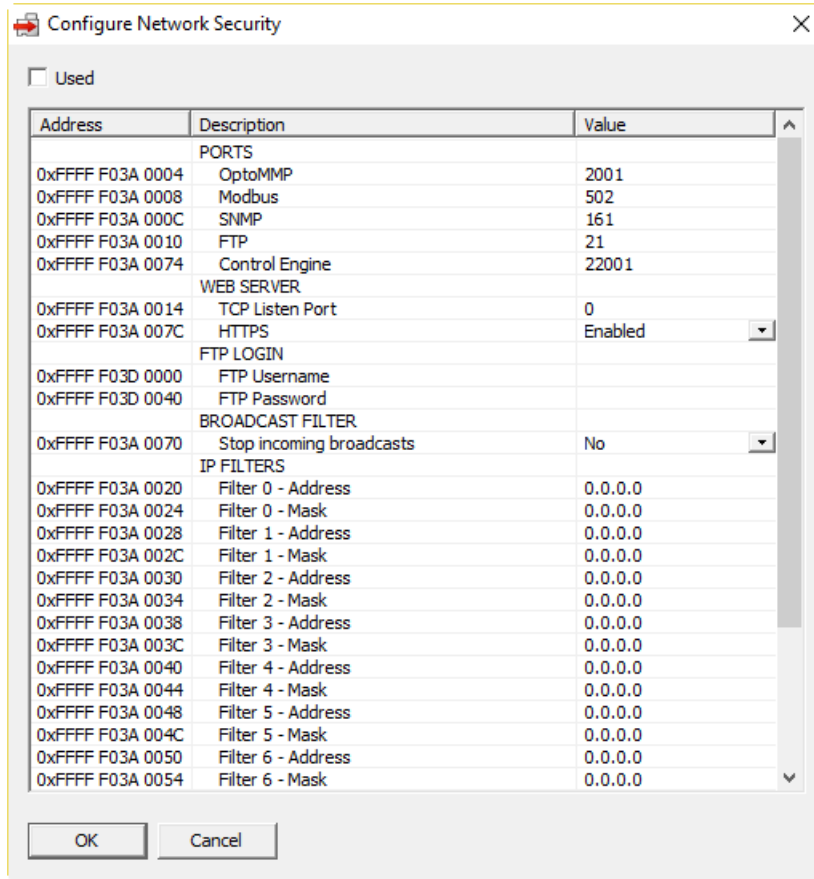

- If there is no check mark in the Used box, click the box to place a check mark there.
- To limit access to a specific protocol, change the Port number in the Value column.

**CAUTION:** If you change the Control Engine port to zero, a strategy that is already in the control engine will still run, but PAC Display, PAC Control, and other hosts will not be able to communicate with it. See [“Protecting a PAC Control Strategy from Interference” on page 97](#).

- To use the built-in HTTP/HTTPS server on a SNAP PAC R-series or S-series controller, see [“Configuring the PAC as an HTTP/HTTPS Server” on page 95](#).
- To set up an FTP login, enter the Username and Password to be required from anyone who uses FTP to access the device.
- To limit access to specific computers, set up to ten filter addresses and filter masks.

The filter address is the IP address that is allowed to access the I/O unit; the filter mask indicates a range of allowed addresses. If only one IP address may access the I/O unit, enter 255.255.255.255 for the filter mask. If a range of IP addresses may access the I/O unit, enter a mask that reflects the subnet range. For example, if only IP address 1.2.3.4 may access the I/O unit, enter 1.2.3.4 as the filter address and 255.255.255.255 as the filter mask. If any IP address that starts with 1.2.3 may access the I/O unit, enter 1.2.3.4 (or 1.2.3.1, or any address in the range) as the filter address and 255.255.255.0 as the filter mask.

*NOTE:* For troubleshooting purposes, you can use the Broadcast Filter value to temporarily turn off incoming broadcasts to the I/O unit. Normally you would NOT want to do this; a BootP response, for example, is an incoming broadcast.

10. When you have finished configuring security, click OK.
11. Configure other optional functions, or return to the PAC Manager main window and click the Save button  to save the configuration file.

*IMPORTANT: If you changed a port number, you must restart the device when you send the configuration to the I/O unit. Otherwise the port change will not take effect.*

When you are ready to upload the configuration file to the I/O unit, see [“Sending Configuration Data to the I/O Unit” on page 83](#).

### PAC-S

## Configuring Ethernet Security on a Standalone Controller

These steps are for a wired network. For security on a wireless LAN, see [page 35](#).

Since this procedure sends the configuration directly to the controller, the controller must be on the same network as your computer.

*NOTE: If you change a port number, you must restart the device in order for the port change to take effect.*

1. In the PAC Manager main window, click the Inspect button .
  - The Inspect window opens.
    - If you haven’t used the Inspect window before, no data is displayed in the Status Read pane.
    - If you *have* used the Inspect window before, the last device you inspected is shown in the Device Name field, and current Status Read information appears in the window.
    - If you have configured other devices, they are listed in alphabetical order in the drop-down list.

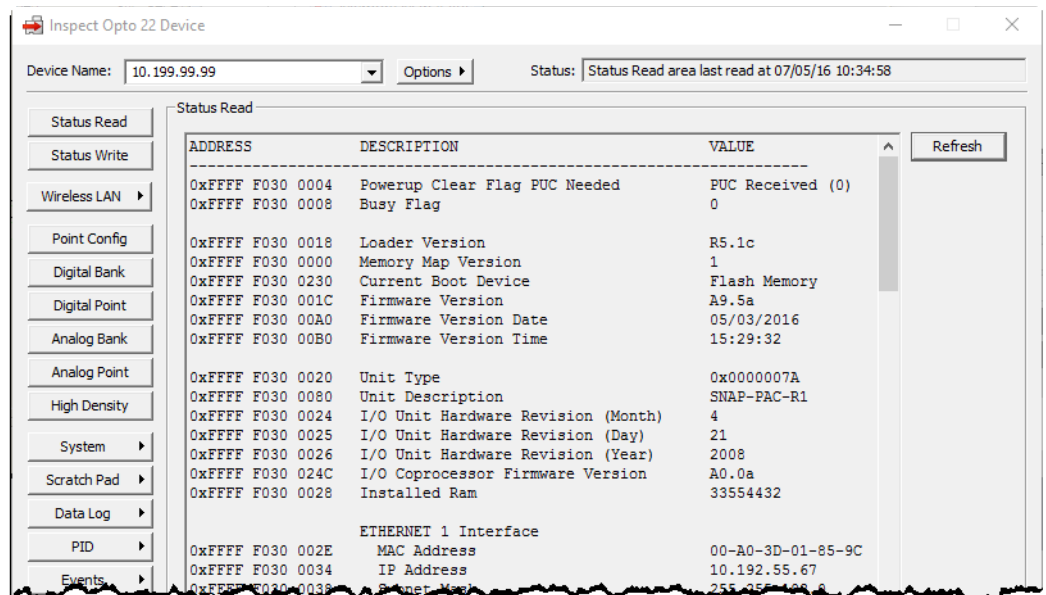

- If you have configured six or more devices, the Inspect window provides two additional time-saving features: Next and Back navigation buttons (to navigate back and forth through the alphabetized list

## SETTING UP NETWORK SECURITY (WIRED NETWORK)

of devices), and a list of the five most recently inspected devices (displayed at the top of the drop-down list).

Next and Back navigation buttons and Most Recently Used list are displayed when you have six or more devices configured.

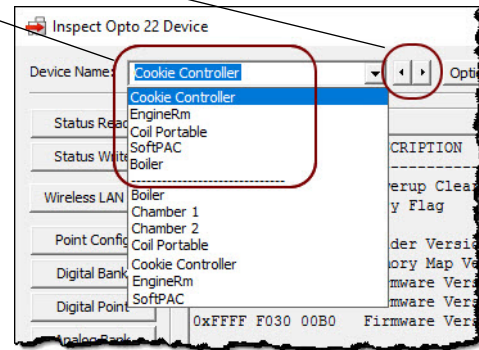

2. In the Device Name field, type the name or IP address of the controller (or choose it from the drop-down list).
3. Click Communications and choose Network Security from the submenu.

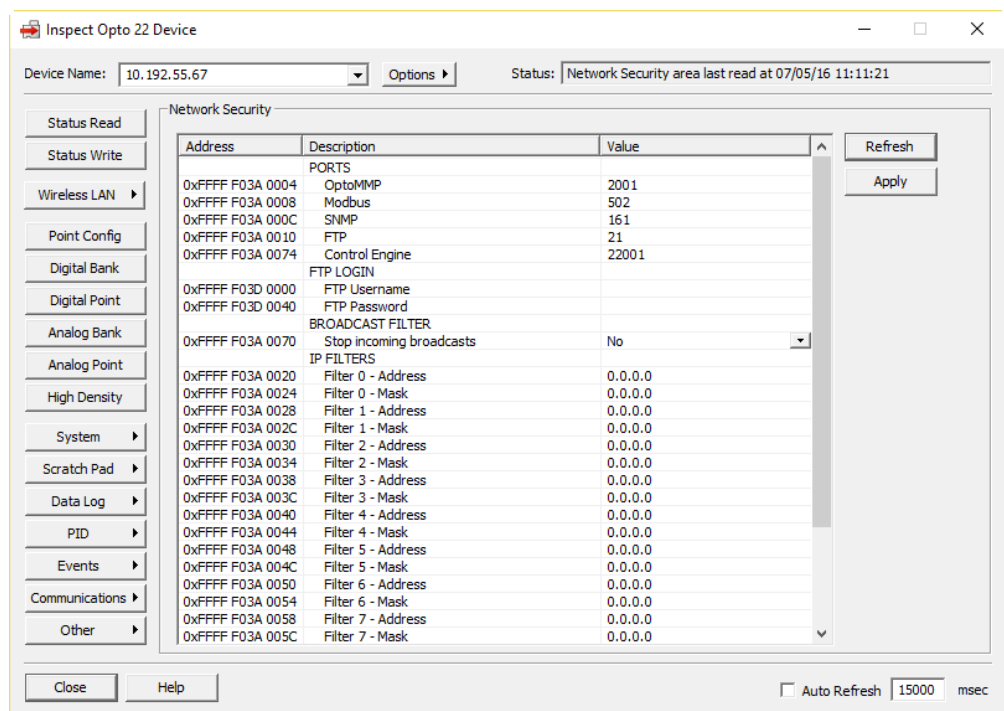

4. To limit access to a specific protocol, change the Port number in the Value column.

*CAUTION: If you change the Control Engine port to zero, a strategy that is already in the control engine will still run, but PAC Display, PAC Control, and other hosts will not be able to communicate with it. See "Protecting a PAC Control Strategy from Interference" on page 97.*

5. To set up an FTP login, enter the Username and Password to be required from anyone who uses FTP to access the device.



6. To limit access to specific computers, set up to ten filter addresses and filter masks.  
The filter address is the IP address that is allowed to access the controller; the filter mask indicates a range of allowed addresses. If only one IP address may access the controller, enter 255.255.255.255 for the filter mask. If a range of IP addresses may access the controller, enter a mask that reflects the subnet range. For example, if only IP address 1.2.3.4 may access the controller, enter 1.2.3.4. as the filter address and 255.255.255.255 as the filter mask. If any IP address that starts with 1.2.3 may access the controller, enter 1.2.3.4 (or 1.2.3.1, or any address in the range) as the filter address and 255.255.255.0 as the filter mask.  
*NOTE: For troubleshooting purposes, you can use the Broadcast Filter value to temporarily turn off incoming broadcasts to the controller. Normally you would NOT want to do this; a BootP response, for example, is an incoming broadcast.*
7. When all the values are correct, click Apply to send the configuration to the controller. If you changed a port number, also restart the controller:
  - a. Click the Status Write button in the upper left.
  - b. In the Operation Command list, highlight Restart Device from powerup.
  - c. Click Send Command.  
The device is restarted and a Success message appears.

## LOGGING DATA FROM MEMORY MAP ADDRESSES

**PAC-R  
EB  
SB  
UIO  
EIO**

You can use a SNAP PAC R-series, EB, or SB, SNAP Ultimate, or SNAP Ethernet I/O unit to log data from up to 64 memory map addresses. The data from all addresses goes into the same data log file, which you can view from PAC Manager. For Ethernet-based I/O units, data from this composite file can also be emailed to someone at a time interval you set. For a complete list of memory map addresses, see the [OptoMMP Protocol Guide](#) (form 1465).

*NOTE: SNAP PAC R-series and SNAP Ultimate on-the-rack controllers have a greater memory capacity than Ethernet brains and can store multiple files for data logging or other purposes. If you are using SNAP PAC-R or SNAP Ultimate, especially with PAC Control, you may prefer to log data in a different way. For more information about the controller's file system, see [page 239](#) and the [PAC Control User's Guide](#) (form 1700).*

*Note that SNAP PAC and SNAP Ethernet brains cannot save logged data if power to the unit is cycled.*

### Configuring Data Logging

1. In PAC Manager, click the Open button  (or in the menu bar, click File > Open).

- In the Open Tag Database dialog box, navigate to the configuration file and double-click it to open it.

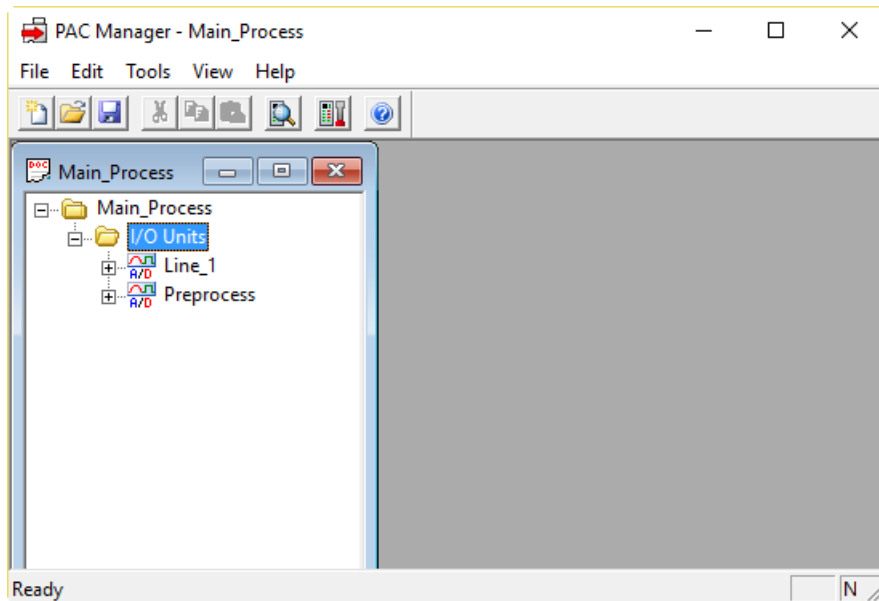

- In the configuration tree, right-click the name of the I/O unit on which you want to set up data logging and choose Configure from the pop-up menu.

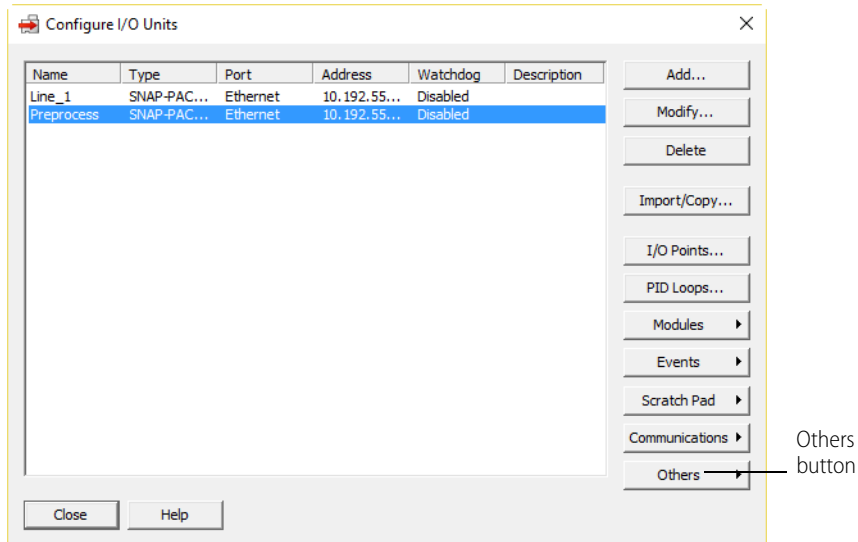

- Click the Others button and choose Data Logging from the pop-up menu.

Address	Description	Value
E-MAIL		
0xFFFF F300 0700	E-mail Enabled for all data logging	No
0xFFFF F300 0704	Number of Datalog entries per E-mail	0
TRIGGER		
0xFFFF F300 0000	Trigger ON	0x 00000000 00000000
0xFFFF F300 0008	Trigger OFF	0x 00000000 00000000
LOGGING		
0xFFFF F300 0010	Address of value to log	0x F0A00000
0xFFFF F300 0014	Data Format	Float (0x66)
0xFFFF F0A0 0000	Current Value	N/A
0xFFFF F300 0018	Logging interval in milliseconds (0 = log once)	5000

Since emails include values from all memory map addresses set up for data logging, entries in this section apply to all data logging points.

- Choose the lowest empty Log Point number from the drop-down list and click to put a check mark in the Used box.

*NOTE: To reduce scanning time, the I/O unit stops scanning log points when it reaches an unused data logging number. Make sure you use these numbers in order, starting with the lowest.*

- (Not applicable to SB brains) To have the data log emailed, click the Value column cell and enable email. Also enter the number of data entries in the log you want each email message to contain. A maximum of 140 log entries can go in each email. Remember that email applies to all points that are logged, since all the data goes into one file.
- In the Value column, click the cell and then enter the Scratch Pad On mask and Off mask to trigger this data log point. Also enter the memory map address of the data you want to log and choose the format of data in that address. Finally, enter how often data should be logged for this address, in milliseconds (to log data just once, enter 0).
- When all values are correct, click OK. Repeat from [step 5](#) for additional log points.
- Remember to also configure email to indicate where the data log should be sent. See [page 116](#).
- Configure other optional functions, or return to the PAC Manager main window and click the Save button  to save the configuration file.

*IMPORTANT: If you have changed the data logging interval, you must save the configuration file to flash memory and restart the I/O unit for the configuration to take effect.*

When you are ready to upload the configuration file to the I/O unit, see [page 83](#).

PAC-R  
EB  
SB  
UIO  
EIO

## Reading the Data Log

The data log is a single file that records data from all the memory map addresses you have configured to log data from (see steps starting on [page 103](#)). The data from up to 64 memory map addresses can be logged, and all logged data is recorded in one file. The log file holds up to 300 lines of data; when it is filled, new entries replace the oldest ones.

This composite log file can be viewed through PAC Manager. (On Ethernet-based I/O units, it can also be emailed to someone at regular intervals you set.) Each line in the log file consists of the date and time stamp, the memory map address the data is coming from, the type of data, and the data itself.

1. To view logged data, click the Inspect button  in the PAC Manager main window.
2. In the Device Name field, enter the name of the I/O unit or choose it from the drop-down list. Click Data Log and choose Data Logging Samples from the pop-up menu.

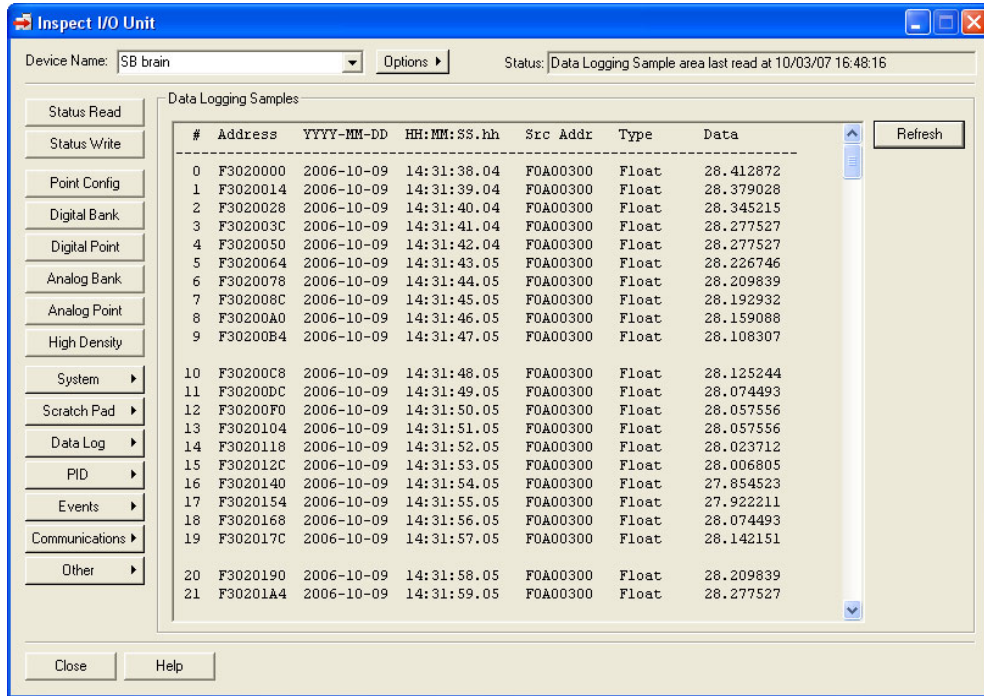

The log includes the following information:

Column	Notes
Address	Address of the data item within the data log itself. Data is logged in memory map addresses F3020000–F302175C. Each data item takes 20 bytes.
YYYY-MM-DD	Date the data was logged
HH:MM:SS.hh	Time the data was logged
Src Addr	Memory map address the data came from
Type	Format of the data
Data	Data from the memory map address. <i>NOTE: -nan means “not a number” and indicates that data is not in the form of an IEEE float.</i>

PAC-R  
EB  
SB  
UIO  
EIO

### Clearing All Data from the Log

1. In the PAC Manager main window, click the Inspect button . The Inspect window opens.
  - If you haven’t used the Inspect window before, no data is displayed in the Status Read pane.
  - If you *have* used the Inspect window before, the last device you inspected is shown in the Device Name field, and current Status Read information appears in the window.

- If you have configured other devices, they are listed in alphabetical order in the drop-down list.

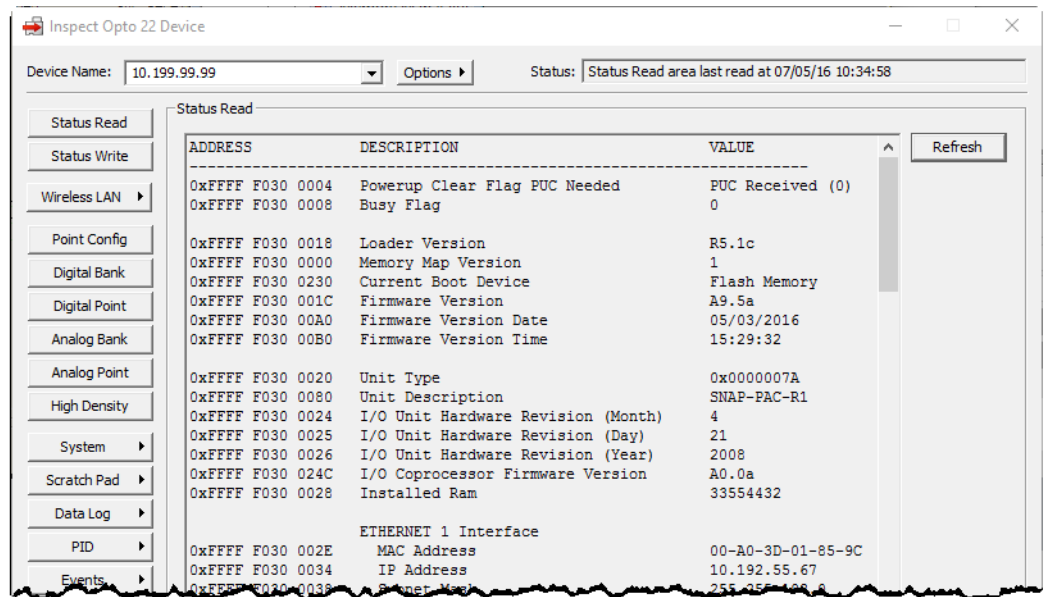

- If you have configured six or more devices, the Inspect window provides two additional time-saving features: Next and Back navigation buttons (to navigate back and forth through the alphabetized list of devices), and a list of the five most recently inspected devices (displayed at the top of the drop-down list).

Next and Back navigation buttons and Most Recently Used list are displayed when you have six or more devices configured.

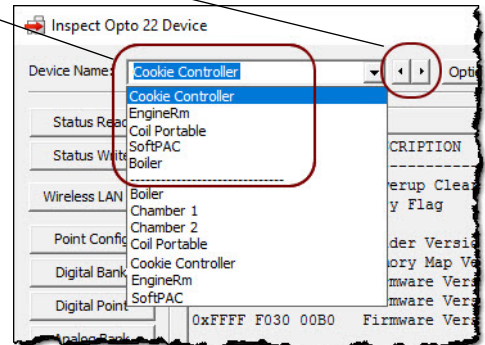

2. In the Device Name field, type the name (or IP address) of the I/O unit or choose it from the drop-down list. Click Status Write.

## CONFIGURING EVENT MESSAGES

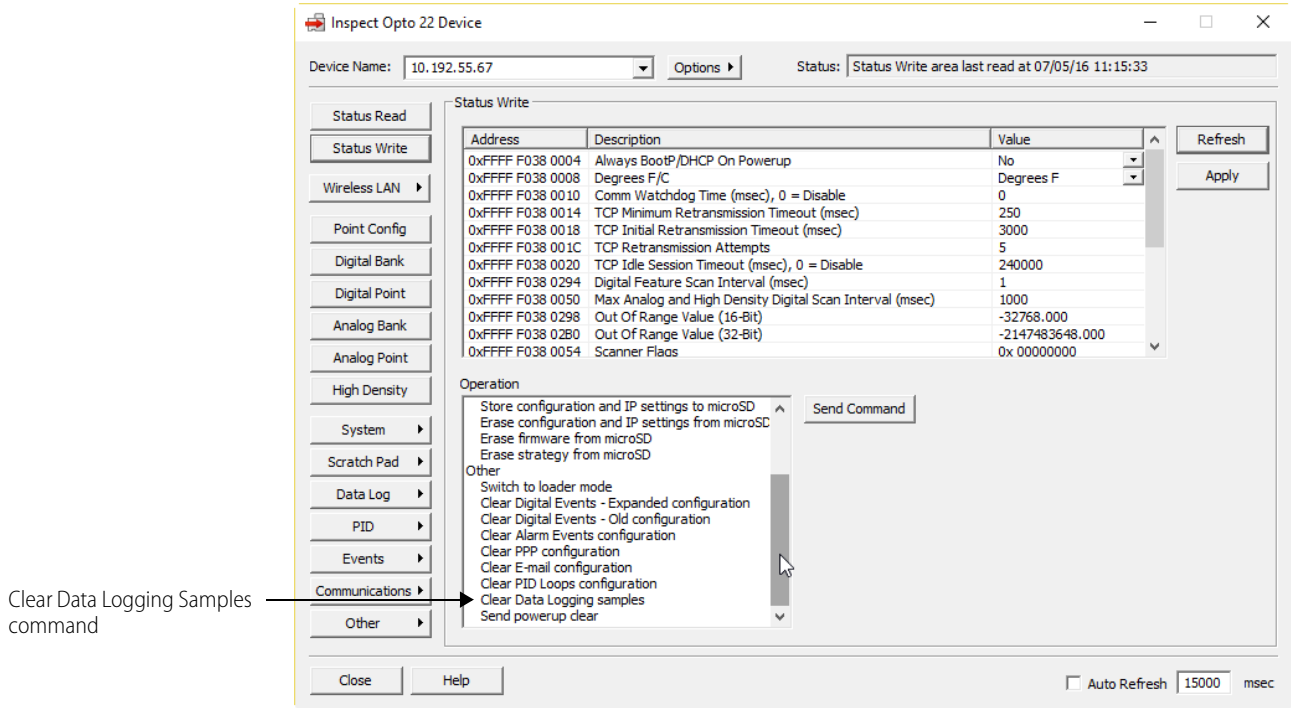

3. In the Operation Commands list, scroll down and click to highlight Clear Data Logging Samples. Click Send Command.  
The data log is cleared and a Success message appears.

## CONFIGURING EVENT MESSAGES

**PAC-S**  
**PAC-R**  
**SoftP**  
**EB**  
**UIO**  
**EIO**

(Not available on SNAP PAC SB brains.) You may need to send a message—via email, data streaming, SNMP, or a serial module—from an I/O unit or a controller when a specific event occurs. For example, you could send a message if a digital point is on, if an analog point reaches a certain value, if a specific string is received through a serial module, or if a variable contains a specific value. You can send one type of message or more.

*NOTE: You must be using a PAC Control strategy or PAC Manager R9.0a or higher to configure event messages in this way. In the PAC Control strategy, your flowchart monitors the event and triggers the message using the command Set I/O Unit Event Message State. Messages must be configured before they can be used in PAC Control.*

*If you are NOT using a PAC Control strategy or are using a PAC Manager version less than R9.0, you cannot configure event messages in a configuration file. You must configure them using Inspect mode. See page 161.*

Follow these steps to configure up to 128 event messages for use with a PAC Control strategy.

1. In PAC Manager, click the Open button  (or in the menu bar, click File > Open).

- In the Open Tag Database dialog box, navigate to the configuration file and double-click it to open it.

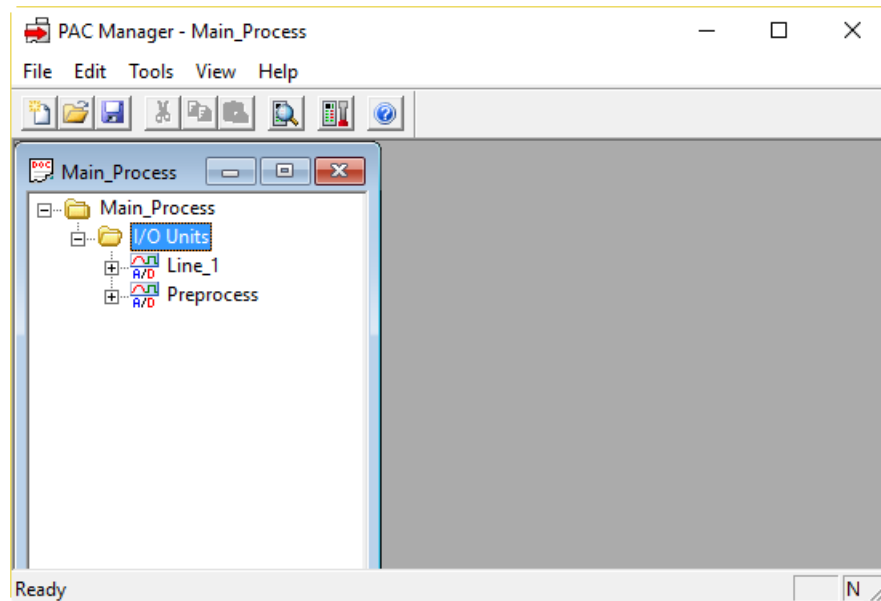

- In the configuration tree, right-click the name of the I/O unit on which you want to set up event messages and choose Configure from the pop-up menu.  
For a SNAP PAC S-series or SoftPAC controller, if it does not already appear in the list, add it as an I/O unit of the type Generic OptoMMP Device with the loopback address (127.0.0.1).

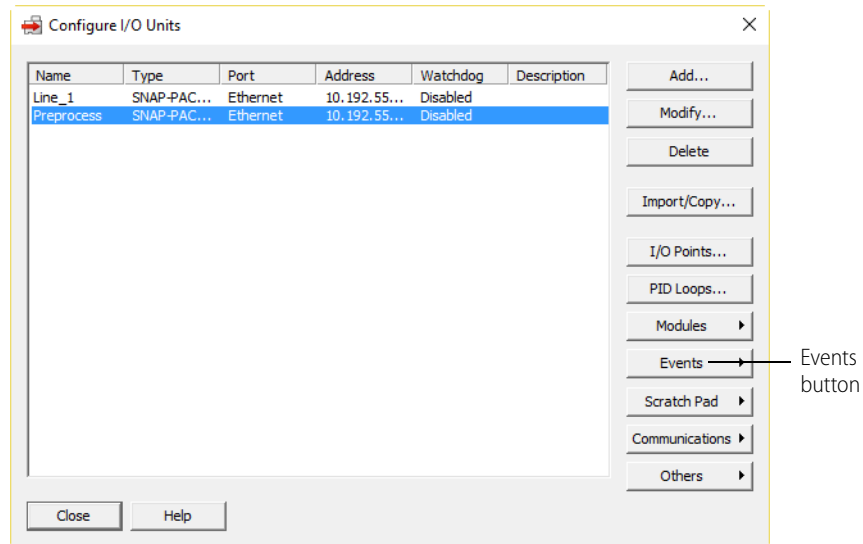

- Click the Events button and choose Event Messages from the pop-up menu.

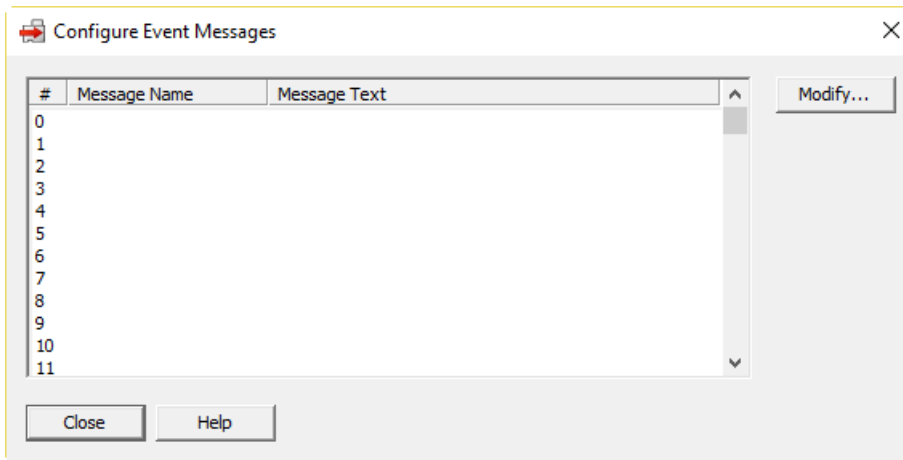

- Highlight an empty message number in the list and click Modify.

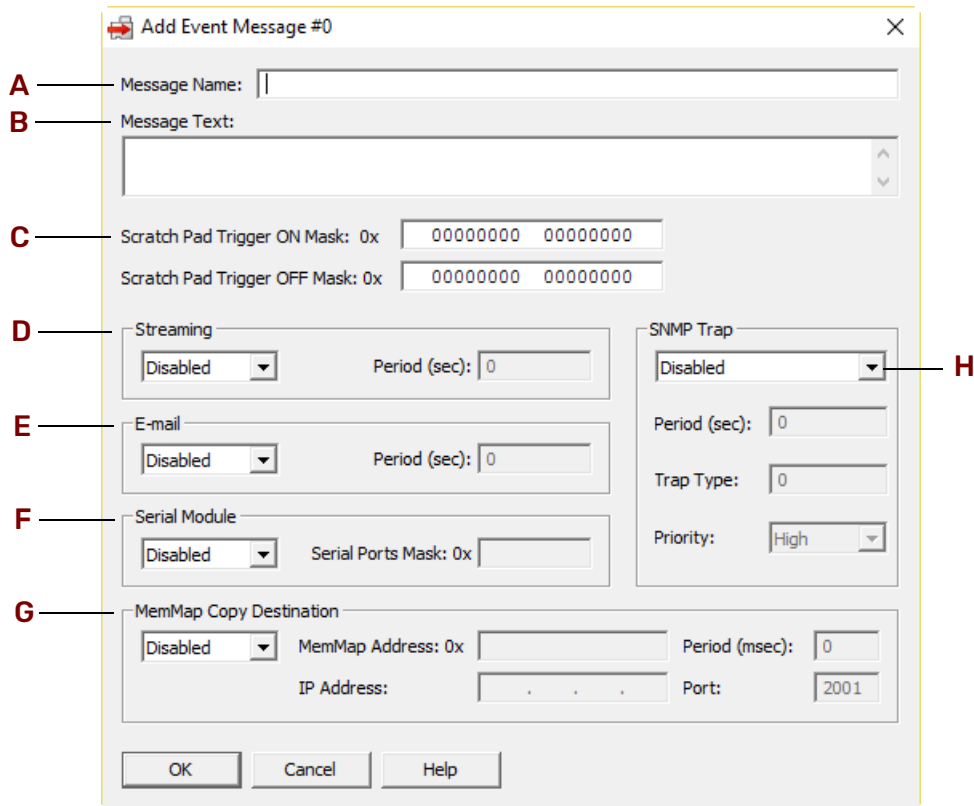

- Complete the fields as follows:

**A—Message Name.** Enter a name for the message.

**B—Message Text.** For an email or serial message, and optionally for an SNMP message, enter the message text. Message text is not sent in the streaming packet.



**C—Message text** is limited to 127 characters. You can place data from the I/O unit's memory map into the message by using a plugin (see [page 111](#)). If you are sending a serial message, make sure the text is formatted so the serial device that receives it will understand it.

**D—Scratch Pad.** To trigger bits in the Scratch Pad, enter the On and Off masks to set.

**E—Streaming.** To send a stream of data as the message, choose Enabled from the drop-down list. Enter how often in seconds to send the stream (0 sends it only once).

**F—E-mail.** To send an email message, choose Enabled from the drop-down list. Enter how often in seconds to send the email (0 sends it only once).

**G—Serial Module.** To send a message through a serial module to a serial device, choose Enabled from the drop-down list. Enter a mask representing the modules and ports to receive the message.

**H—Mem Map Copy Configuration.** To copy memory map data, see [page 125](#).

**I—SNMP Trap.** To send an SNMP trap as the message, choose Enabled from the drop-down list. Enter how often to send the trap (0 sends it only once). Also enter the trap type (determined by your SNMP management software). If you are using SNMP with outgoing PPP and want the trap stored in the I/O unit until the next communication, set Priority to Low. If you want the I/O unit to immediately dial out and send the trap, set Priority to High.

*NOTE: SNMP messages must be acknowledged. If the Period is set to more than zero, the alarm will continue to be sent until the trap is acknowledged and the Scratch Pad trigger is reset to zero.*

*In PAC Control, you can use the command Set I/O Unit Event Message State to build the acknowledgment into the flowchart logic.*

*In PAC Manager, you can acknowledge the trap and reset the Scratch Pad by using Inspect > Events > Event Messages (change State to Acknowledged and reset Scratch Pad bits).*

7. When all fields are correct, click OK.
8. When you have configured all event messages, click Close.
9. For each type of message you configure, make sure you also set up basic configuration:

Serial: [page 60](#)  
 SNMP: [page 112](#)  
 Email: [page 116](#)  
 Streaming: [page 120](#)

10. Configure other optional functions, or return to the PAC Manager main window and click the Save button  to save the configuration file.

When you are ready to upload the configuration file to the I/O unit, see [“Sending Configuration Data to the I/O Unit” on page 83](#).

## USING PLUGINS

**PAC-R**  
**EB**  
**UIO**  
**EIO**

Several plugins are available for use in event messages and memory map copying. The following table guides you in using them.

To do this	Use this plugin	In these places	See
Include the pattern string from a serial communication module.	<code>\$!_str_</code>	Serial messages	<a href="#">page 108</a>

To do this	Use this plugin	In these places	See
Show which serial port sent the pattern string.	<code>\$_port_</code>	Serial messages	<a href="#">page 108</a>
Include data from a memory map address. X = type of data (S=string representation of the data, D=integer, F=float, P=IP address, B=4 binary bytes) YYYYYYYY = memory map address (see examples below)	<code>\$_X_YYYYYYYY_</code>	Event messages Memory map copying	<a href="#">page 108</a> <a href="#">page 125</a>
Number emails with a sequence ID	<code>\$_seqid_</code>	Email messages	<a href="#">page 108</a>
Turn digital points on or off using a bit mask	<code>&amp;#x00000000_</code>	Memory map copying	<a href="#">page 125</a>

*NOTE: For email messages, message text including plugins must be 127 bytes (characters) or less. The message length after all plugins have been expanded into their data values must be 255 bytes or less.*

### Examples

#### Including Data from Memory Map Addresses

For the complete list of memory map addresses, see the appendix in the [OptoMMP Protocol Guide](#) (form 1465).

Here are a couple of examples:

To include the on/off state of a switch on module 0, point 3, you would put this in the message:

```
$_D_F08000C0_
```

To include the temperature of an ICTD input on module 4, point 0, you would use:

```
$_F_F0A00400_
```

#### Sending Binary Data in Event Messages

To send binary data in the text of an event message, begin with `&#x` and end with `_`. You can include any number of ASCII hex digits up to the 127-byte limit for the message field. You can also include multiple `&#x` plugins. This plugin is resolved after all other plugins have been resolved, and only just before sending the contents of the message field out of the specified serial ports. Examples:

To include an embedded null (one binary character):

```
&#x00_
```

To include a number of binary characters:

```
&#x0a0dCF0034_
```

## CONFIGURING SNMP

PAC-S  
PAC-R  
SoftP  
EB  
UIO  
EIO

**(Not available on SB brains)** The Simple Network Management Protocol (SNMP) is used to communicate with an SNMP-based enterprise management system, such as Computer Associates' Unicenter®, Hewlett-Packard's OpenView®, or IBM's Tivoli®, over Ethernet. These enterprise management systems can manage analog, digital, or serial devices through a SNAP PAC controller or SNAP PAC, SNAP Ultimate, or SNAP Ethernet I/O unit just as they manage computer equipment on the Ethernet network.

## SNMP Traps

You can set up the controller or I/O unit to send messages to the management system in the form of SNMP traps. The device can send three kinds of traps:

- Authentication trap—sent when a host requests data that is outside its access permissions
- Cold start trap—sent whenever the I/O unit is turned on
- Exception trap—sent in reaction to an event; an exception trap is a type of event message.

Authentication and cold start traps can be enabled using the steps in this section. To configure exception traps, see “Configuring Event Messages” on page 108.

## SNMP Access Privileges

*Community groups* control access to SNMP information from the controller or I/O unit. When you set up a community group, you determine its privileges to read, write to, and receive traps from the system.

In order to receive traps, a host must be a registered *management host* and be part of a community group that has access privileges for traps. Once a registered management host becomes part of a community group, that group is no longer available to non-registered hosts. It includes only the hosts registered to it.

To set up community groups, follow the steps in this section. You can define up to eight community groups.

## Configuring the SNMP Agent

1. In PAC Manager, click the Open button  (or in the menu bar, click File > Open).
2. In the Open Tag Database dialog box, navigate to the configuration file and double-click it.

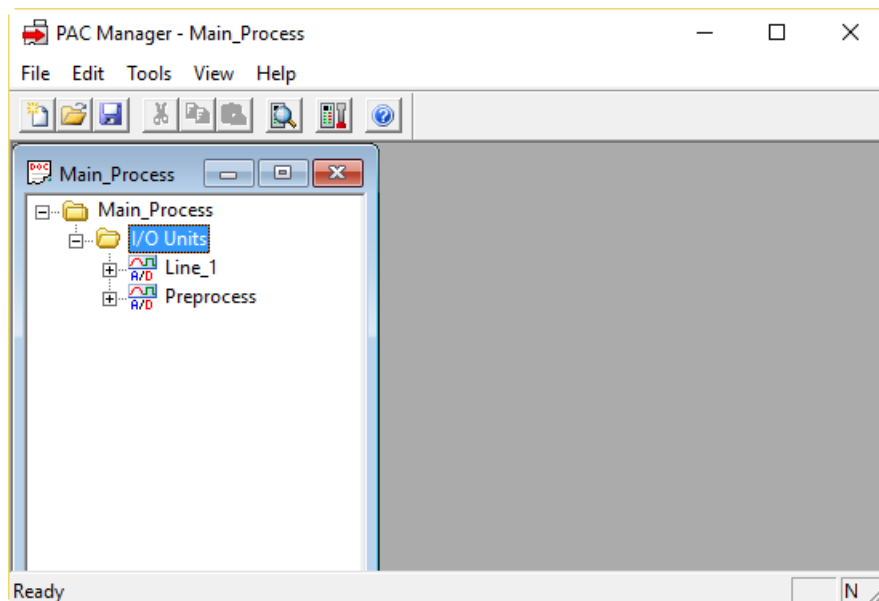

3. In the configuration tree, right-click the name of the I/O unit on which you want to set up SNMP and choose Configure from the pop-up menu.

For a SNAP PAC S-series or SoftPAC controller, if it does not already appear in the list, add it as an I/O unit of the type Generic OptoMMP Device with the loopback address (127.0.0.1).

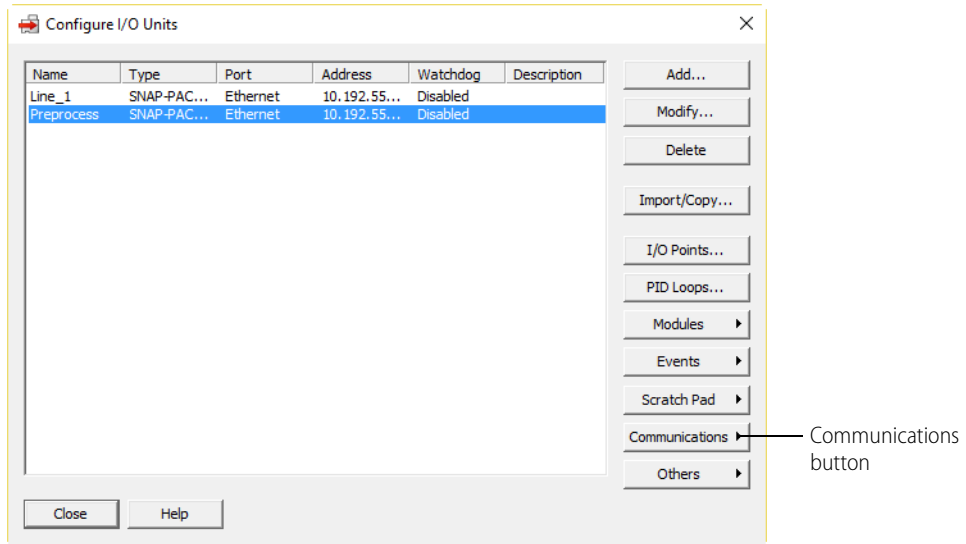

4. Make sure the correct I/O unit is highlighted in the list. Click the Communications button and choose SNMP from the pop-up menu.

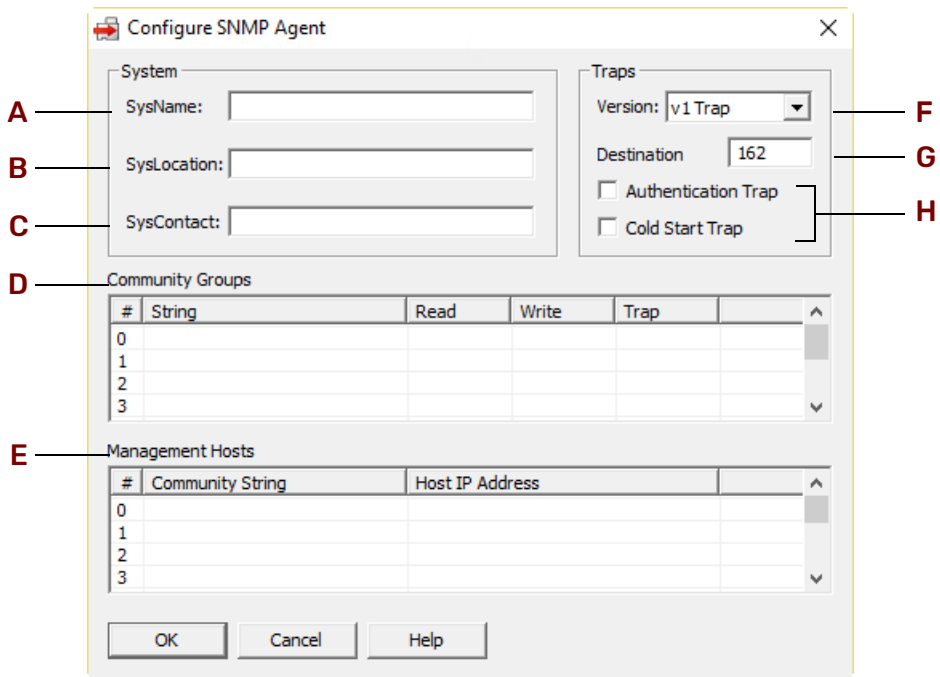

5. Complete the fields as follows:

**A—SysName.** Enter the name assigned to the I/O unit as a managed node within the SNMP management system.

**B—SysLocation.** Enter the physical location of the I/O unit.

**C—SysContact.** Enter the ID of the contact person for the I/O unit.

**D—Community Groups.** To set up the Community Groups you need, highlight a line in the list. Click the String cell within the line and type the name of the group. Then click in the Read, Write, and Trap cells and choose Yes or No from the drop-down list to indicate whether that group has privileges to read, write, and receive traps.

**E—Management Hosts.** To set up Management Hosts, highlight a line in the list. Start with hosts on the local network first, because the system sends messages to hosts in numeric order. Click the Community String cell and enter the name of the community group the host belongs to. Click the Host IP Address cell and enter its IP address, including the dots (for example, 10.192.55.60).

**F—Version.** (All I/O units except SNAP Simple and SNAP Ethernet) From the drop-down list, choose the version of SNMP you are using.

**G—Destination Port.** 162 is the default port for SNMP traps. If you know that your application will use a different port, enter the number of that port here.

**H—Authentication/Cold Start Trap.** To enable authentication or cold start traps, click the box to check it.

- When all fields are correct, click OK.

*IMPORTANT: For the configuration to take effect, you must upload the configuration file to the I/O unit, save it to flash memory, and restart the I/O unit.*

- Configure other optional functions, or return to the PAC Manager main window and click the Save button  to save the configuration file.

When you are ready to upload the configuration file to the I/O unit, see [“Sending Configuration Data to the I/O Unit” on page 83.](#)

## CONFIGURING DNS SERVERS

If you want to use host names in PAC Control comm handles or in SMTP messaging configuration, use the DNS Resolver to designate one or two DNS servers to resolve host names into IP addresses. The servers are queried one at a time in the order listed.

- In Inspect mode, click the Communications button and choose DNS Resolver from the pop-up menu.

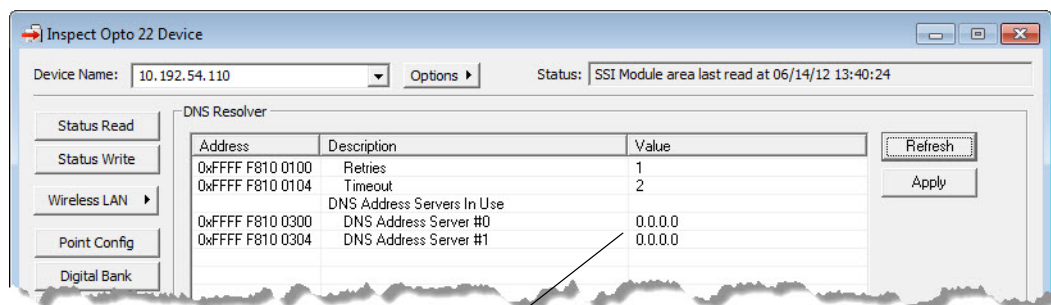

0.0.0.0 indicates that the DNS server is not being used.

## CONFIGURING EMAIL

2. To add a DNS server address or to change the Retries or Timeout, click the appropriate value in the Value column. When you have finished changing values, click Apply.

Memory Map Address	Description	Purpose
0xF8100100	Retries	Number of times DNS resolution will be retried. (Default values is 1.)
0xF8100104	Timeout	Number of seconds DNS resolver waits for a response to a request. (Default value is 2.)
0xF8100300	DNS Address Server #0	Address of the Primary DNS Server
0xF8100304	DNS Address Server #1	Address of the Secondary DNS Server

3. When you have finished changing values, click Apply.  
The values are sent to the controller and stored to flash memory. Then you are prompted to restart the controller.
4. Restart the controller to use the new configuration.

## CONFIGURING EMAIL

PAC-S  
PAC-R  
SoftP  
EB  
UIO  
EIO

(Not available on SB brains) You can send an email message or page someone in response to an event. Follow the steps in this section to set up email parameters. See [“Configuring Event Messages” on page 108](#) to set up the message itself.

1. In PAC Manager, click the Open button  (or in the menu bar, click File > Open).
2. In the Open Tag Database dialog box, navigate to the configuration file and double-click it to open it.

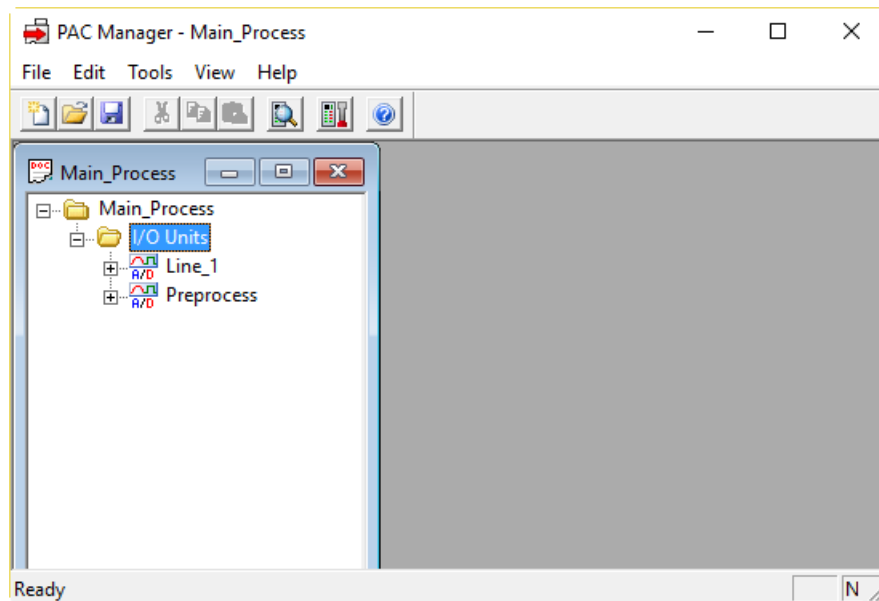

3. In the configuration tree, right-click the name of the I/O unit on which you want to set up email and choose Configure from the pop-up menu.

For a SNAP PAC S-series or SoftPAC controller, if it does not already appear in the list, add it as an I/O unit of the type Generic OptoMMP Device with the loopback address (127.0.0.1).

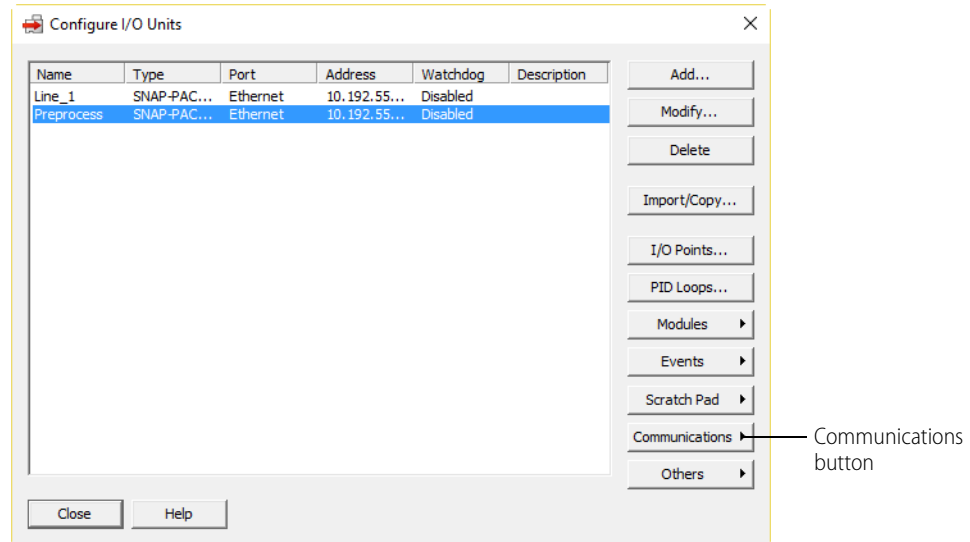

4. Make sure the correct I/O unit is highlighted in the list. Click the Communications button and choose E-mail from the pop-up menu.

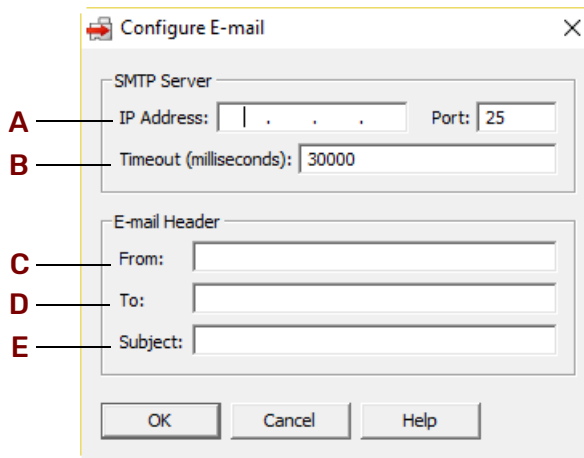

5. Complete the fields as follows:

**A—IP Address.** Enter the IP address and port number of the Simple Mail Transfer Protocol (SMTP) server the I/O unit will use to send email. You should be able to get this information from your network administrator.

**B—Timeout.** Enter the length of time in milliseconds the I/O unit should wait for a response from the email server. The default is 30,000.

**C—From.** Enter a valid email address that will identify the I/O unit to the person who receives the email.

**D—To.** Enter the email address of the person who will receive the email.

## SETTING UP INITIAL VALUES IN THE SCRATCH PAD AREA

**E—Subject.** Enter a phrase that will indicate the purpose of the email to the person receiving it. Note that this subject line applies to all email messages sent by this I/O unit. Plugins can be used in this field. For example, if a similar email will be sent at intervals (such as an email of the data log), you can use the seqid plugin to put a sequence number at the end of each subject line. This plugin is in this format:

\$!\_seqid\_

So, for example, if you enter `Process Data Log $!_seqid_` in the subject field, the first email message will have a subject line of `Process Data Log 0`, the next message will have a subject line of `Process Data Log 1`, and so on. For information on other plugins, see [“Using Plugins” on page 111](#).

6. When all fields are correct, click OK.

*IMPORTANT: For the configuration to take effect, you must upload the configuration file to the I/O unit, save it to flash memory, and restart the I/O unit.*

7. Configure other optional functions, or return to the PAC Manager main window and click the Save button  to save the configuration file.

When you are ready to upload the configuration file to the I/O unit, see [“Sending Configuration Data to the I/O Unit” on page 83](#).

## SETTING UP INITIAL VALUES IN THE SCRATCH PAD AREA

PAC-S  
PAC-R  
SoftP  
EB  
SB  
UIO  
EIO

Before you use this section, read [“Event/Reaction Concepts” on page 145](#).

To set initial Scratch Pad values and save them as part of the configuration file, follow these steps. (To see Scratch Pad values or change them in real time, see [“Reading and Writing to the Scratch Pad Area” on page 206](#).)

1. In PAC Manager, click the Open button  (or in the menu bar, click File > Open).
2. In the Open Tag Database dialog box, navigate to the configuration file and double-click it to open it.

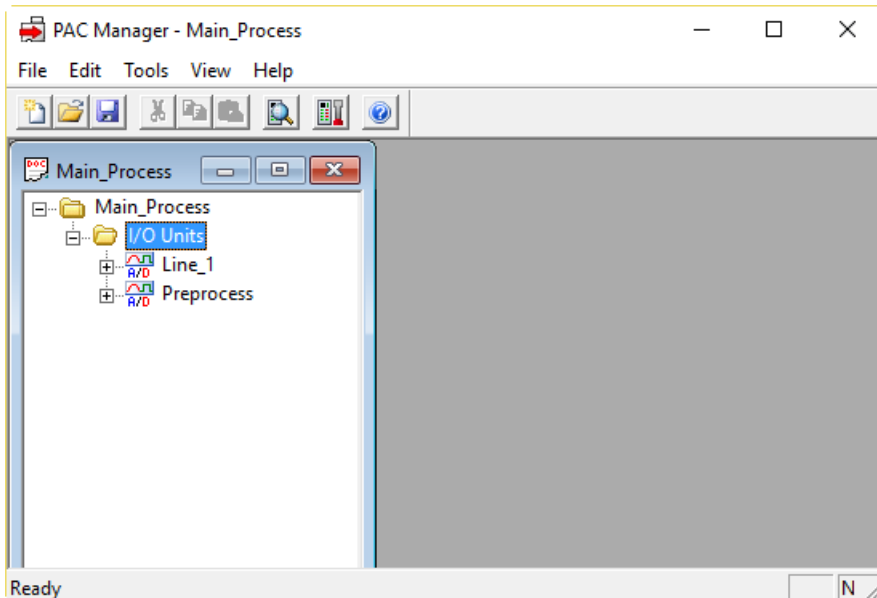

3. If you are using a SNAP PAC S-series or SoftPAC controller, configure an I/O unit to represent the controller for Scratch Pad purposes. Configure this I/O unit as a Generic OptoMMP Device, using the loopback address (127.0.0.1). (Do not add any points or configure other features.)



- In the configuration tree, right-click the name of the I/O unit on which you want to configure the Scratch Pad and choose Configure from the pop-up menu.

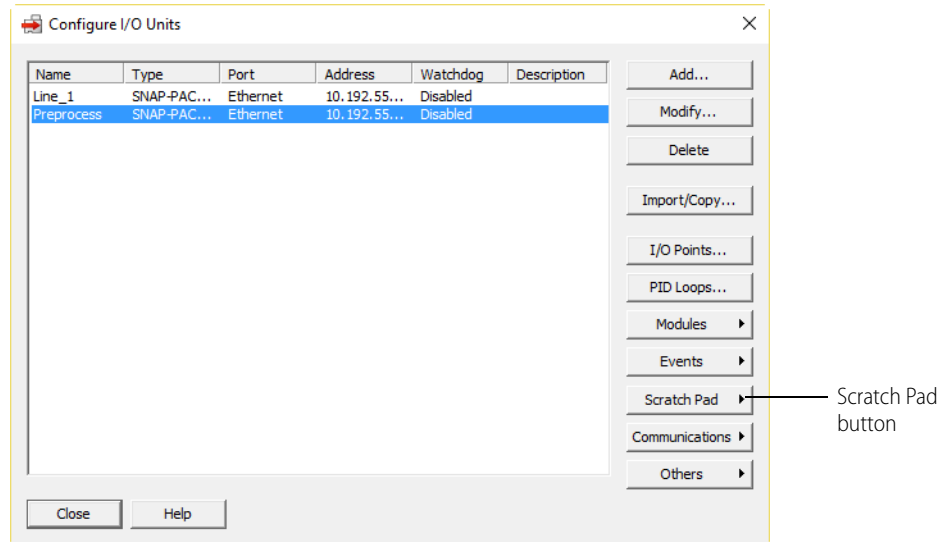

- Make sure the correct I/O unit is highlighted in the list. Click the Scratch Pad button and choose Bits, Integers, Floats, or Strings from the pop-up menu.

PAC-S  
PAC-R  
SoftP  
EB  
SB  
UIO  
EIO

### Scratch Pad Bits

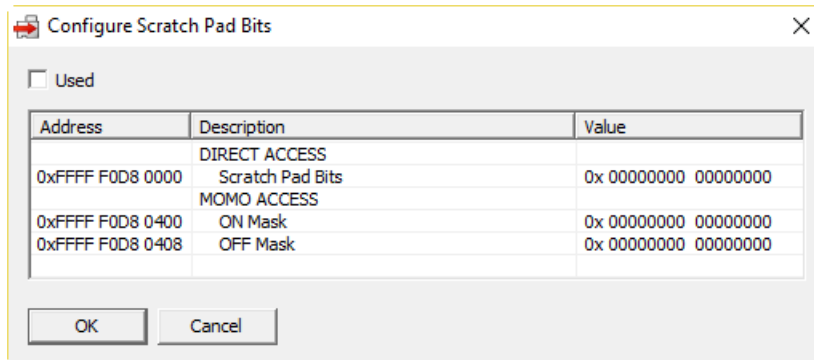

- Click to put a check mark in the Used box.
- Click the cell in the Value column to set initial values for either the bits in the Direct Access area or the MOMO masks in the MOMO Access area.
- Click OK.

PAC-S  
PAC-R  
SoftP  
EB  
SB  
UIO

### Scratch Pad Integers, Floats, or Strings

The Configure Scratch Pad Floats dialog box is shown as an example. The dialog boxes for strings, 32-bit integers, and 64-bit integers are similar.

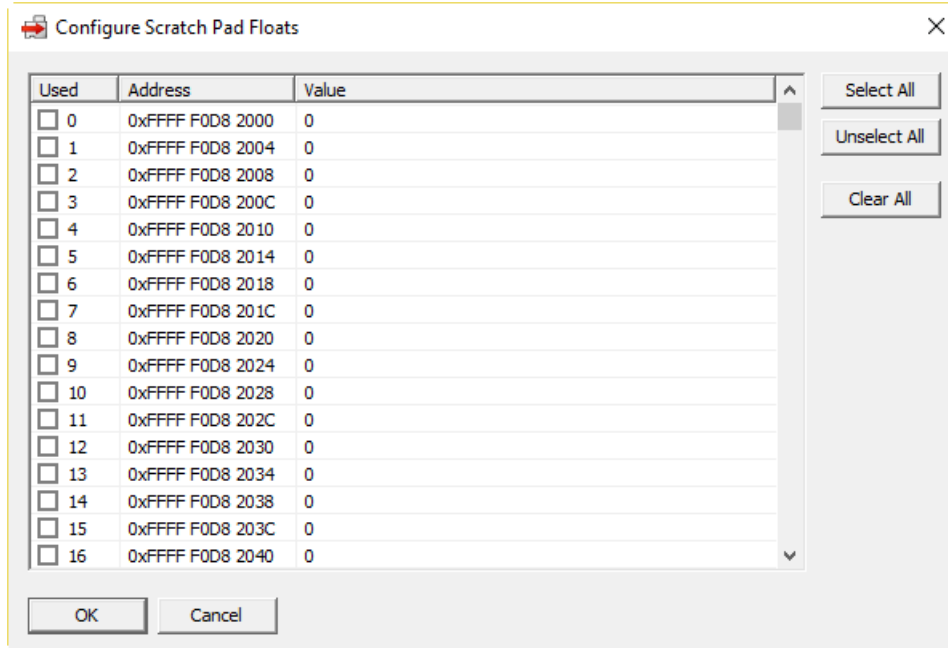

1. For each integer you want to use, click to put a check mark in its box in the Used column. Click the cell in the Value column and enter the initial value.
2. Repeat for each integer. When all integers have been set, click OK.

## CONFIGURING STREAMING

PAC-R  
EB  
UIO  
EIO  
SIO

(Not available on SB brains) Most Ethernet communication involves the two-step process of request and response. A faster way of getting information from the I/O unit, however, is by streaming data. Streaming does not use TCP/IP; it uses the User Datagram Protocol (UDP/IP) instead.

*NOTE: Because Modbus/TCP runs on TCP, not UDP, streaming data via Modbus/TCP is not possible. However, you can stream to a non-Modbus host at the same time you are using the Modbus/TCP protocol for another purpose.*

Streaming is a fast way to get continuous data from the I/O unit and is ideal for data acquisition applications. When it streams, the system sends data at regular intervals to specified IP addresses. You set up the interval, the IP addresses to receive the data, and (optionally) the port number. The system sends the data at the specified interval. The communication is one-way; the system does not wait for a response.

*CAUTION: If you stream to multiple IP addresses, and one or more of the streaming targets is either offline or not running the application that receives the stream, delays may occur. If a target is offline, the I/O system will stop streaming while it tries to resolve the IP address. If the application is not running on the computer that receives the stream, the computer will send the I/O system an error message; if the stream occurs frequently, the additional error messages can slow down the network.*

Streaming involves two steps: setting up parameters on the I/O unit for streaming, and receiving data in your application. Follow the steps in this section to set up the parameters. For information on receiving data in your application, see the [OptoMMP Protocol Guide](#) (form 1465).

1. In PAC Manager, click the Open button  (or in the menu bar, click File > Open).
2. In the Open Tag Database dialog box, navigate to the configuration file and double-click it to open it.

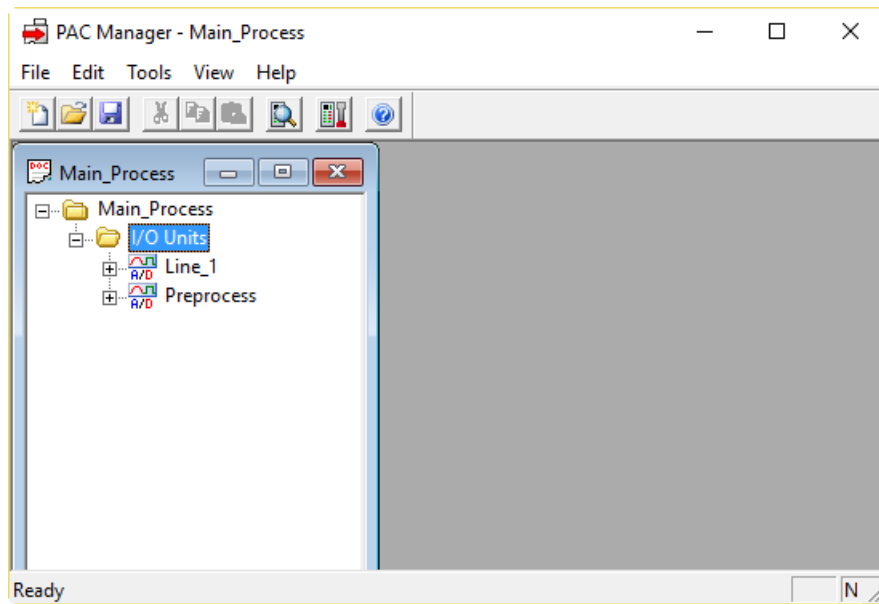

3. In the configuration tree, right-click the name of the I/O unit on which you want to set up streaming and choose Configure from the pop-up menu.

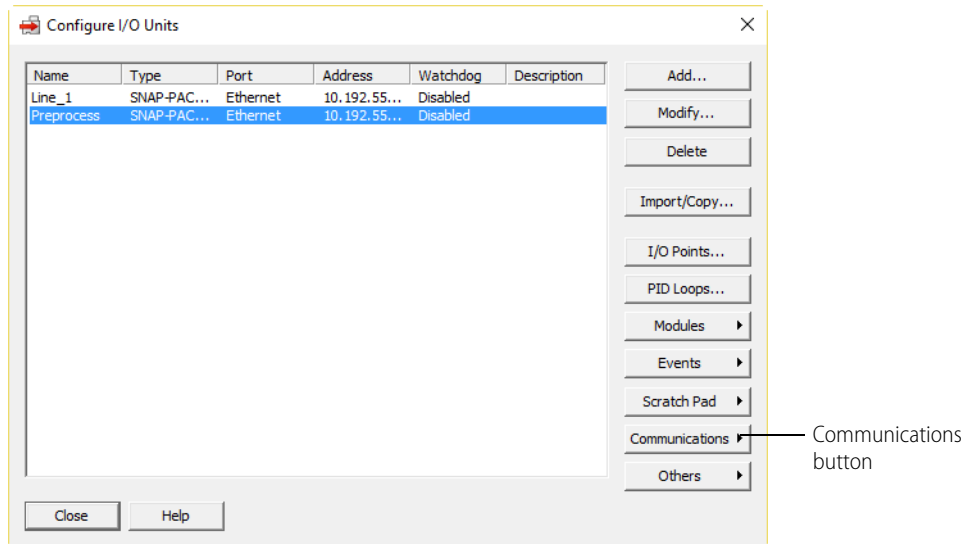

4. Make sure the correct I/O unit is highlighted in the list. Click the Communications button and choose Streaming from the pop-up menu.

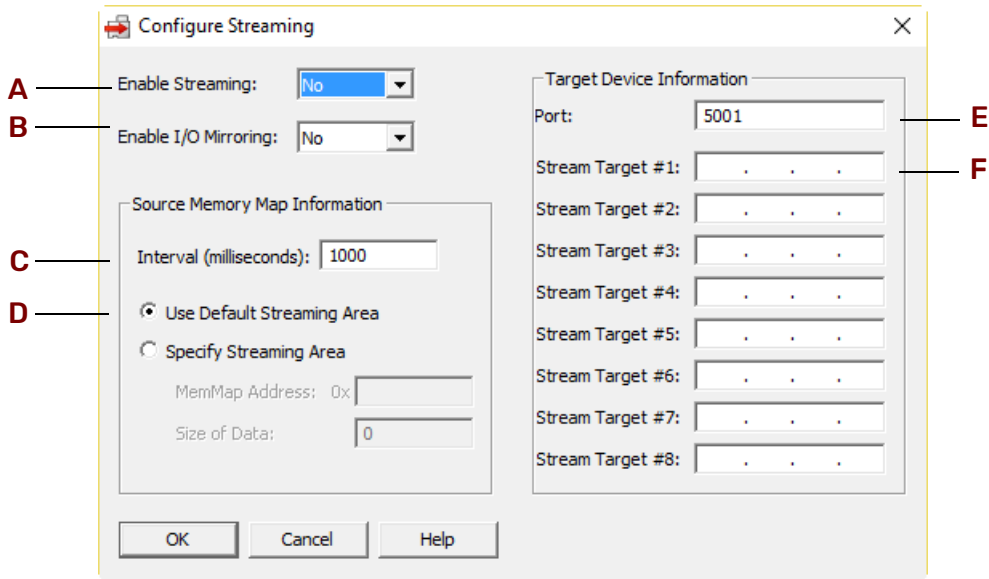

5. Complete the fields as follows:

**A—Enable Streaming.** To enable streaming, choose Yes from the drop-down list.

**B—Enable I/O Mirroring.** I/O mirroring is a separate function. It’s generally not a good idea to use both streaming and mirroring on the same I/O unit. See [“Mirroring I/O Point Data” on page 123](#) for more information.

**C—Interval.** Enter how often in milliseconds you want the I/O unit to send the streamed data. If you are configuring streaming to use only as an event message, set the streaming interval to 0. Zero means that the stream will be sent only once.

**D—Use Default Streaming Area.** To stream all addresses in the Streaming section of the I/O unit’s memory map, click Use Default Streaming Area. For more information, see the memory map appendix in the [OptoMMP Protocol Guide](#) (form 1465). (Note that the Streaming section does not include data from high-density digital modules.)

To stream only part of the Streaming section, or to stream a different part of the memory map, click Specify Streaming Area. Enter the starting address in the Memory Map Address field (the address must be entered in hex), and enter the size in bytes of the data to stream in the Size Of Data field.

**E—Port.** Enter the port on the computers or devices that receive the streamed data. Your application must refer to this port number. Use the default of 5001 unless you know it is already being used for another purpose.

**F—Stream Target.** Enter the IP addresses of up to eight devices to receive the streamed data.

6. When all fields are correct, click OK.

7. Configure other optional functions, or return to the PAC Manager main window and click the Save button  to save the configuration file.

When you are ready to upload the configuration file to the I/O unit, see [“Sending Configuration Data to the I/O Unit” on page 83](#).

## MIRRORING I/O POINT DATA

**PAC-R**  
**EB**  
**UIO**  
**EIO**

(Not available on SB brains) Mirroring I/O point data is a way to automatically change all the points on one I/O unit to match all the points on another I/O unit. A simple example of mirroring is controlling whether lights in one facility are on or off by having them mirror the on or off status of switches in another facility.

Mirroring reads the current analog bank values (in Engineering Units) and the current digital bank status (4-channel digital modules only, not high-density digital modules) of the points on a system and writes the data to the same point numbers on a second system. The reading and writing occurs as often as you specify. In our lighting system example, the status of switches in Facility A could be read every minute and automatically written to the lights in Facility B. When someone turns on the switches in Facility A, the lights in Facility B would automatically be turned on within a minute.

It's generally not a good idea to use both mirroring and streaming on the same I/O unit. If you do use both, streaming target #1 will receive both mirroring and streaming packets; the streaming packets are ignored, but they unnecessarily add to network traffic.

*NOTE: Due to the size limit of the mirroring packet, mirroring for digital points occurs on the first 32 points of the I/O unit only (points on the modules in positions 0–7). Mirroring cannot be used with high-density digital modules.*

Follow these steps to set up I/O point data mirroring:

1. In PAC Manager, click the Open button  (or in the menu bar, click File > Open).
2. In the Open Tag Database dialog box, navigate to the configuration file and double-click it to open it.

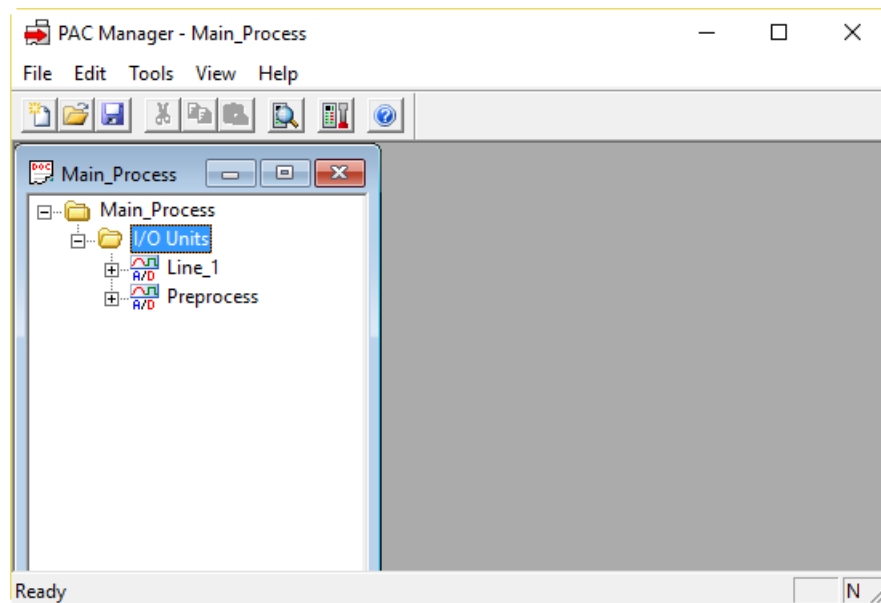

- In the configuration tree, right-click the name of the I/O unit on which you want to set up mirroring and choose Configure from the pop-up menu.

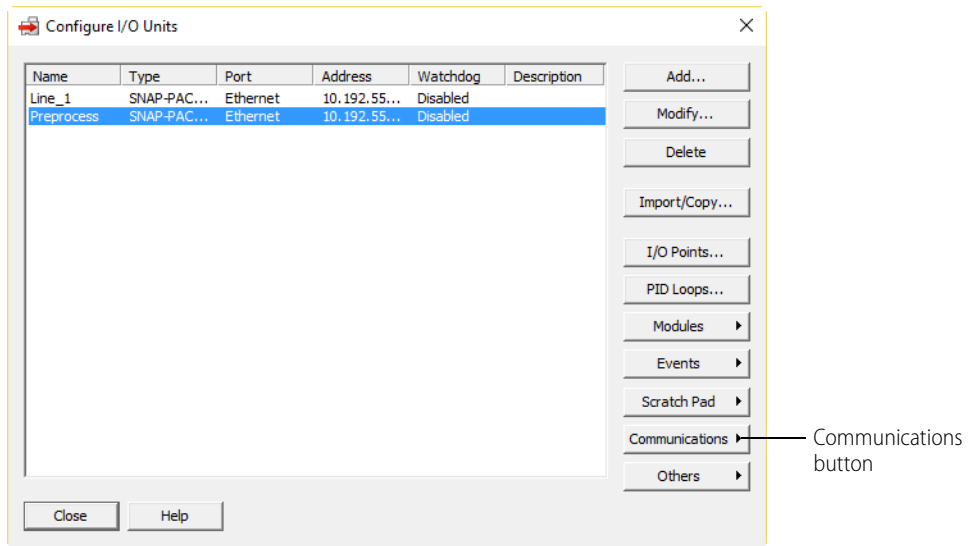

- Make sure the correct I/O unit is highlighted in the list. Click the Communications button and choose Streaming from the pop-up menu.

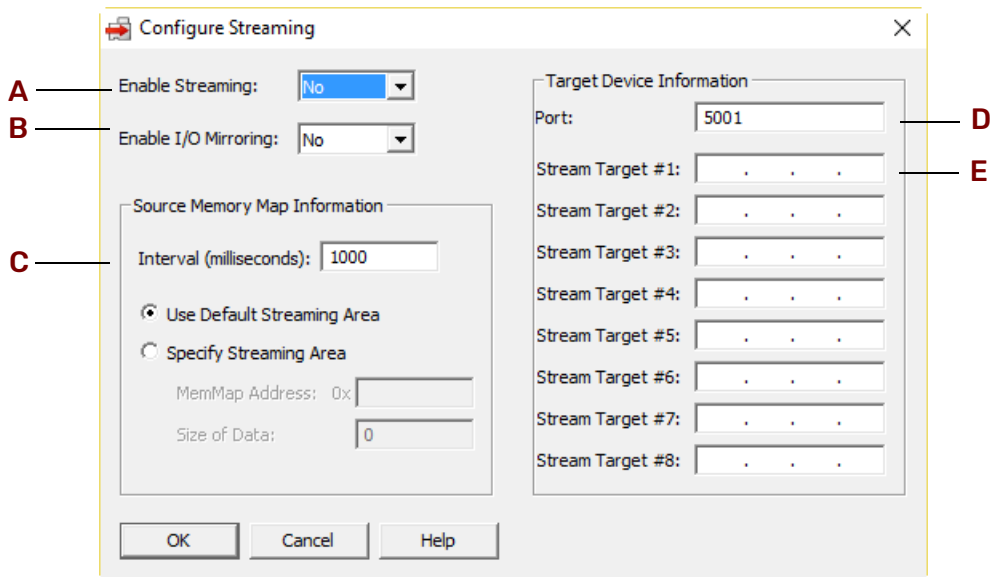

- Complete the fields as follows:

**A—Enable Streaming.** Streaming is a separate function. It’s generally not a good idea to use both streaming and mirroring on the same I/O unit. See [“Configuring Streaming” on page 120](#) for more information.

**B—Enable I/O Mirroring.** To enable mirroring, choose Yes from the drop-down list.

**C—Interval.** Enter how often in milliseconds the data should be mirrored.

**D—Port.** Enter the port number. This is the primary port number used to communicate with the I/O unit. The default shown is 5001; enter 2001 instead. (Exception: if you changed the MMP port for security reasons, use the number you changed it to.)

**E—Stream Target.** Enter the IP address of the I/O unit to receive the mirrored data.

*CAUTION: Since all digital and analog points are mirrored, make sure that the points on the second I/O unit are configured to accept the values that will be written to them.*

6. When all fields are correct, click OK.
7. Configure other optional functions, or return to the PAC Manager main window and click the Save button  to save the configuration file.

When you are ready to upload the configuration file to the I/O unit, see [“Sending Configuration Data to the I/O Unit” on page 83](#).

## COPYING MEMORY MAP DATA

**PAC-R**  
**EB**  
**UIO**  
**EIO**

(Not available on SB brains) You can use memory map copying to do the following:

- Copy data on the same I/O unit
- Copy data to a memory map location on another unit

### Copying Binary or Memory Map Data on the Same I/O Unit

You can copy data on the same I/O unit, for example to write the value of an analog point to another analog point.

1. Follow the steps in [“Configuring Event Messages” on page 108](#) until you reach the Add Event Message # dialog box.

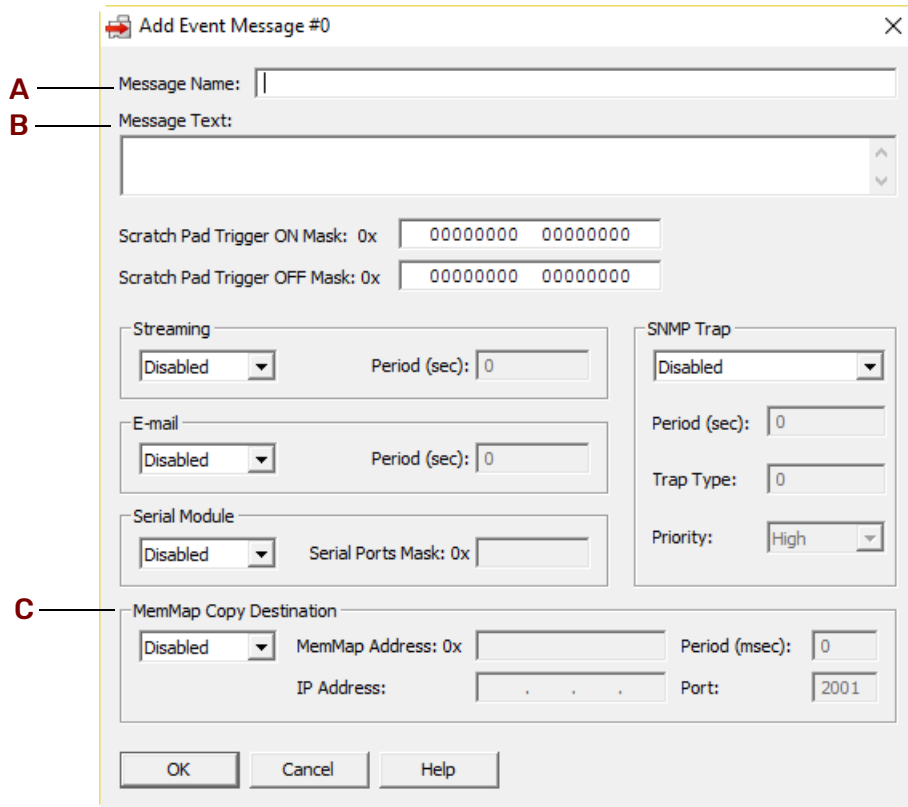

2. Complete the fields as follows:

**A—Message Name.** Enter a descriptive name for the message.

**B—Message Text.** In the Message Text section, enter a plugin containing a memory map address to write *from* (the source address), in the following format:

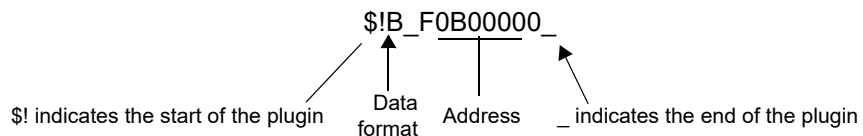

or a four-byte constant, in this format:

$\&\#x00000001\_$

Constants must be written in exactly four bytes (8 characters).

While the data format indicator in the plugin can be other types (D=integer, F=float, B is typically used for memory map copying). The other types copy a *string representation* of the data, since plugins are primarily used for generating messages and emails.

**C—MemMap Copy Destination.** In the MemMap Copy Destination area, choose Enabled from the drop-down list. Enter the Memory Map Address you are copying *to* (the destination address) as an eight-digit hex number (the last eight digits of the address, for example, F0B00040). In the Period field, enter how often to send the data, in milliseconds.

Since the points you are copying to are on the same I/O unit, type 0.0.0.0 for the IP Address, and ignore the TCP port field.



- When all fields are correct, click OK.
- Configure other optional functions, or return to the PAC Manager main window and click the Save button  to save the configuration file.

When you are ready to upload the configuration file to the I/O unit, see [“Sending Configuration Data to the I/O Unit” on page 83](#).

PAC-R  
EB  
UIO  
EIO

### Copying Binary or Memory Map Data to a Different I/O Unit

You can also copy data to an address on a different system. Configure the event message in the source system (the one you are copying *from*), but make sure that any points you are affecting on the destination system are configured to accept the data.

- Follow the steps in [“Configuring Event Messages” on page 108](#) until you reach the Add Event Message # dialog box.

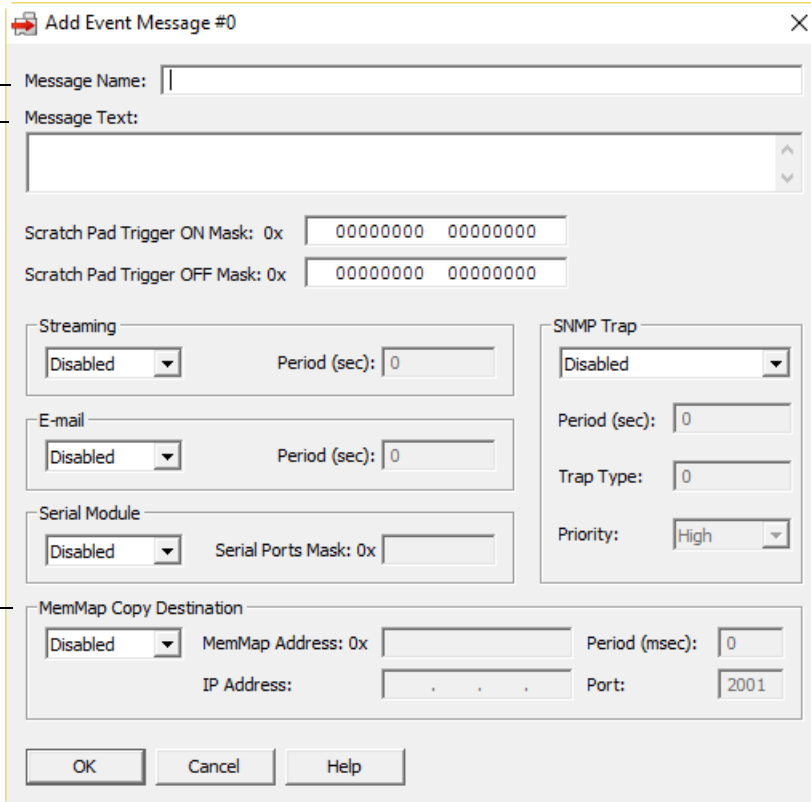

**A** Message Name:

**B** Message Text:

Scratch Pad Trigger ON Mask: 0x

Scratch Pad Trigger OFF Mask: 0x

Streaming: Disabled  Period (sec):

E-mail: Disabled  Period (sec):

Serial Module: Disabled  Serial Ports Mask: 0x

SNMP Trap: Disabled  Period (sec):  Trap Type:  Priority: High

**C** MemMap Copy Destination: Disabled  MemMap Address: 0x  Period (msec):  IP Address:    Port:

OK Cancel Help

- Complete the fields as follows.

**A—Message Name.** Enter a descriptive name for the message.

**B—Message Text.** In the Message Text section, enter a plugin containing a memory map address to write from (the source address), in the following format:

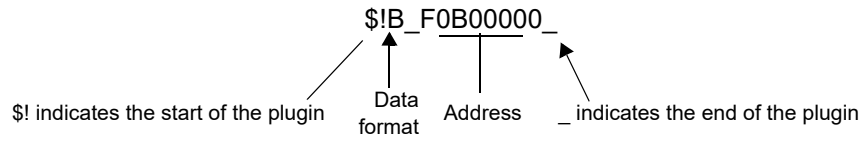

or a four-byte constant, in this format:

&#x00000001\_

Constants must be written in exactly four bytes (8 characters).

While the data format indicator in the plugin can be other types (D=integer, F=float, B is typically used for memory map copying. The other types copy a *string representation* of the data, since plugins are primarily used for generating messages and emails.

**C—MemMap Copy Destination.** In the MemMap Copy Destination area, choose Enabled from the drop-down list. Enter the Memory Map Address you are copying to (the destination address) as an eight-digit hex number (the last eight digits of the address, for example, F0B00040). In the Period field, enter how often to send the data, in milliseconds.

Also enter the IP Address and TCP port for the I/O unit whose point you are copying to (the destination system). TCP port is usually 2001.

3. When all fields are correct, click OK.
4. Configure other optional functions, or return to the PAC Manager main window and click the Save button  to save the configuration file.

When you are ready to upload the configuration file to the I/O unit, see [“Sending Configuration Data to the I/O Unit” on page 83](#).

## CONFIGURING MODBUS OPTIONS

PAC-S  
PAC-R  
SoftP  
EB  
UIO  
EIO  
SIO  
E1  
E2

(Not available on SB brains) If you are using Modbus/TCP to communicate with a SNAP device, see the [Modbus/TCP Protocol Guide](#) (form 1678).

Using PAC Manager, you can change the Modbus float format. In addition, if you need to read or write data in areas of the device’s memory map that are not included in the Modbus memory map (shown in the protocol guide), you can use PAC Manager to determine the Modbus Unit ID and Register Address that are equivalent to the memory map address you want to use.

### Changing Modbus Float Format

1. In PAC Manager, click the Open button  (or in the menu bar, click File > Open).

- In the Open Tag Database dialog box, navigate to the configuration file and double-click it to open it.

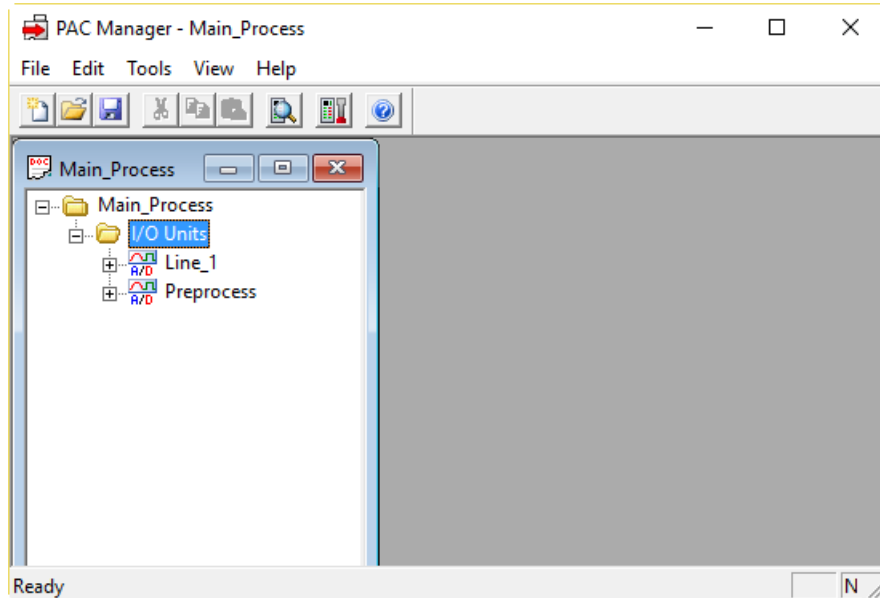

- In the configuration tree, right-click the name of the I/O unit on which you want to change Modbus float format and choose Configure from the pop-up menu.

For a SNAP PAC S-series or SoftPAC controller, if it does not already appear in the list, add it as an I/O unit of the type Generic OptoMMP Device with the loopback address (127.0.0.1). (Do not add any points.)

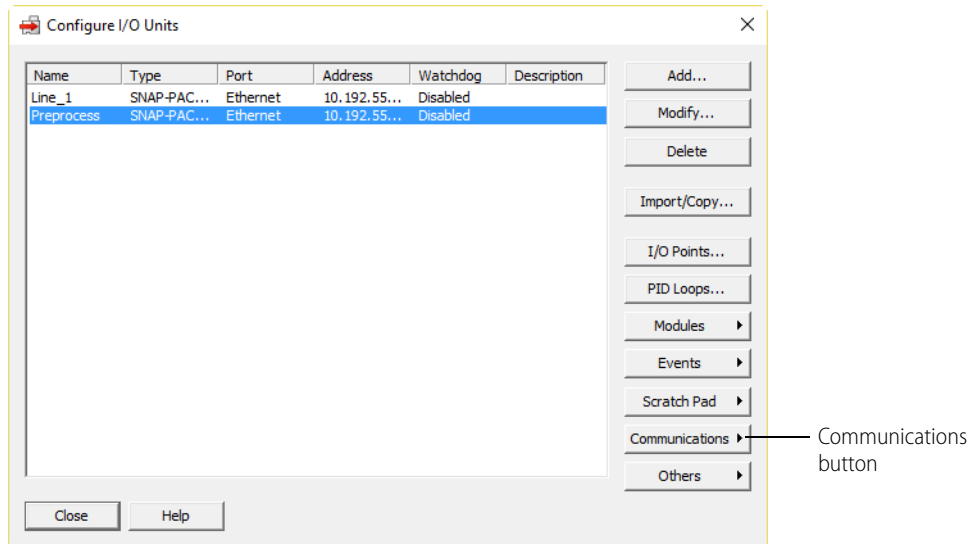

- Click the Communications button and choose Modbus from the pop-up menu.

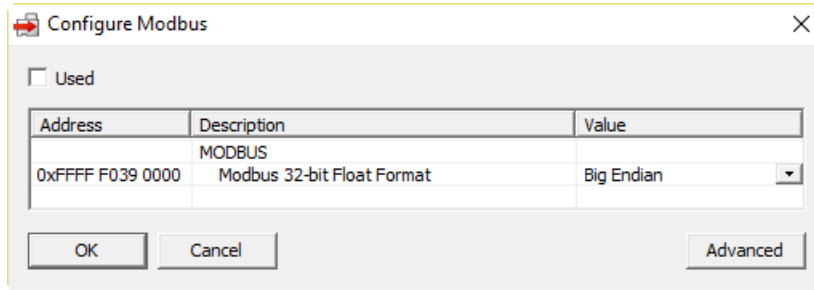

- Click to place a check mark in the Used box. In the Value column, click the value shown for float format. Choose the format you want from the drop-down list.

*NOTE: Word swapped is still Big Endian, but places the most significant bit in the most significant register.*

- When the value you want is shown, click OK.
- Configure other optional functions, or return to the PAC Manager main window and click the Save button  to save the configuration file.

When you are ready to upload the configuration file to the I/O unit, see [“Sending Configuration Data to the I/O Unit” on page 83](#).

PAC-S  
PAC-R  
SoftP  
EB  
UIO  
EIO  
SIO  
E1  
E2

### Determining Modbus Unit ID and Register Address

If you need to read or write data to the device’s memory map in areas not included in the Modbus memory map, you can use PAC Manager to convert memory map addresses to Modbus Unit ID and Register Addresses, or vice versa. For more information, see the [Modbus/TCP Protocol Guide](#) (form 1678).

- Determine the device’s memory map address (or the Modbus Unit ID and Register Address) you want to convert.  
To find out the memory map address, you can use the memory map appendix in the [OptoMMP Protocol Guide](#) (form 1465), or you can copy and paste the address from the Inspect dialog box in PAC Manager.
- In the PAC Manager main window, with a configuration file open, right-click an I/O unit and choose Configure from the pop-up menu.
- In the Configure I/O Units dialog box, click the Communications button and choose Modbus from the pop-up menu.

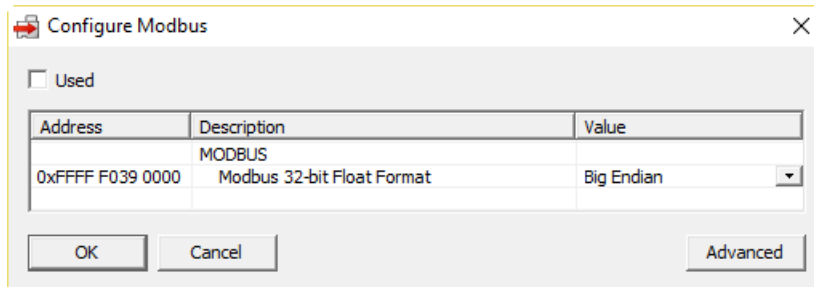

- Click the Advanced button to see the rest of the dialog box.

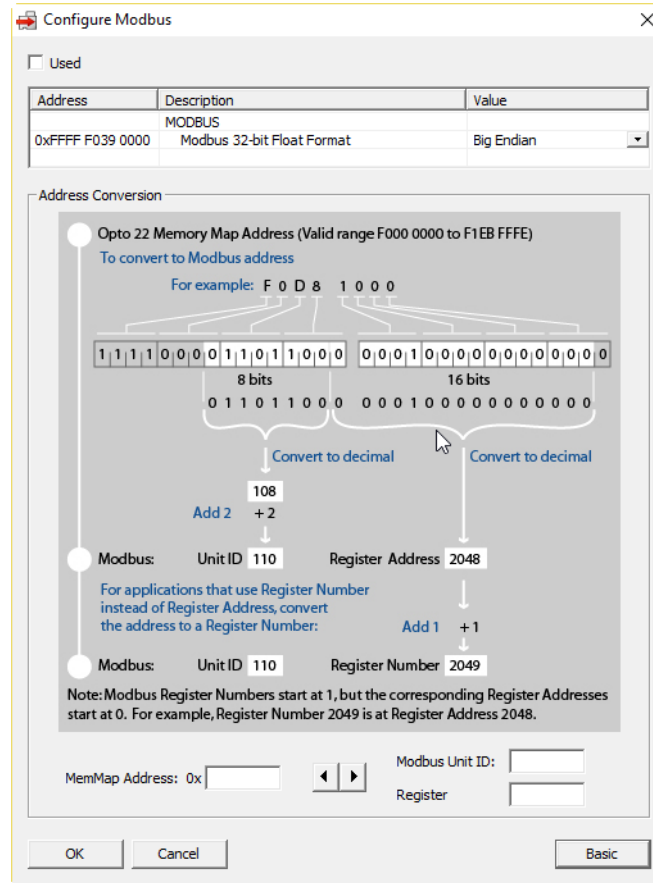

- To convert an I/O unit memory map address to a Modbus Unit ID and Register Address, type the last eight digits of the I/O unit's memory map address in the MemMap Address field. Make sure there are no spaces in the address (for example, type F0300020).
- Click the right-arrow button .

## SETTING UP SYSTEM DATE AND TIME

The equivalent Modbus address appears. Note that the Modbus numbers are decimal.

The screenshot shows the 'Configure Modbus' dialog box. At the top, there is a table with columns 'Address', 'Description', and 'Value'. The first row shows '0xFFFF F039 0000' for 'MODBUS' with a 'Value' of 'Big Endian'. Below this is the 'Address Conversion' section. It starts with 'Opto 22 Memory Map Address (Valid range F000 0000 to F1EB FFFE)'. An example 'F 0 D 8 1 0 0 0' is shown. A diagram illustrates the conversion: the first 8 bits (11110000) are converted to decimal (108) and 2 is added to get 'Unit ID 110'. The next 16 bits (0110110000000000) are converted to decimal (2048) and 1 is added to get 'Register Address 2048'. For applications using Register Number, the address is converted to 'Register Number 2049'. A note states: 'Note: Modbus Register Numbers start at 1, but the corresponding Register Addresses start at 0. For example, Register Number 2049 is at Register Address 2048.' At the bottom, there are input fields: 'MemMap Address: 0x F00763E4' and 'Modbus Unit ID: 5', 'Register: 45554'. Arrows point from the text 'Memory map address (in hex)' to the MemMap Address field and 'Equivalent Modbus address (decimal)' to the Modbus Unit ID and Register fields.

- To convert from Modbus to a memory map address, type the Unit ID and Register Address and click the left-arrow button.  
The equivalent memory map address appears.

## SETTING UP SYSTEM DATE AND TIME

**PAC-R**  
**EB**  
**SB**  
**UIO**  
**EIO**

SNAP PAC devices and SNAP Ultimate controllers and SNAP-ENET-RTC Ethernet brains have a built-in clock. (Other SNAP Ethernet-based brains do not have this feature.) The clock is set at the factory before the device is shipped to you. If necessary, you can set the date and time on an I/O unit by following these steps. (For a SNAP PAC S-series controller, see [“Reading System Date and Time” on page 206.](#))

*NOTE: If you are using PAC Control and want to synchronize the I/O unit’s time with your computer’s time, don’t use these steps; instead, follow the instructions in the [PAC Control User’s Guide \(form 1700\).](#)*

- In PAC Manager, click the Open button  (or in the menu bar, click File > Open).

- In the Open Tag Database dialog box, navigate to the configuration file and double-click it to open it.

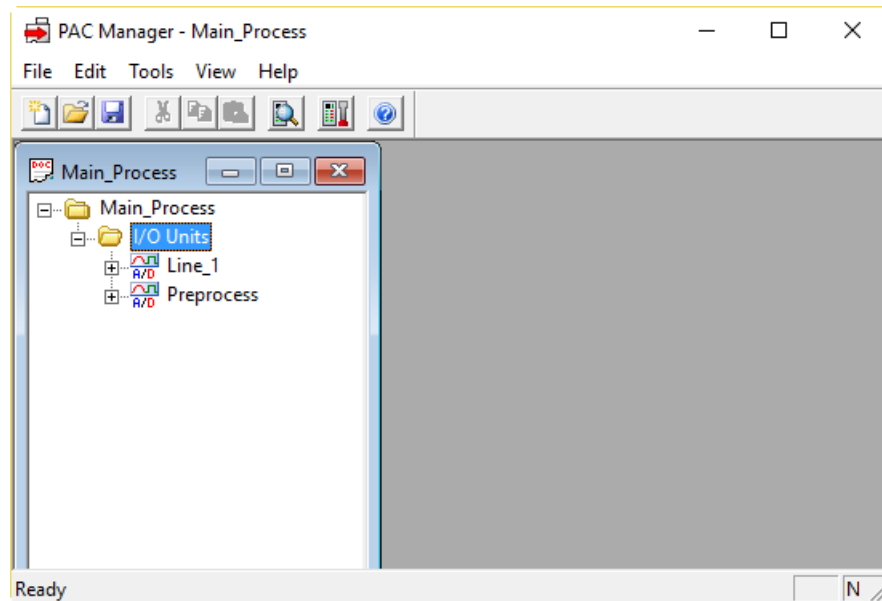

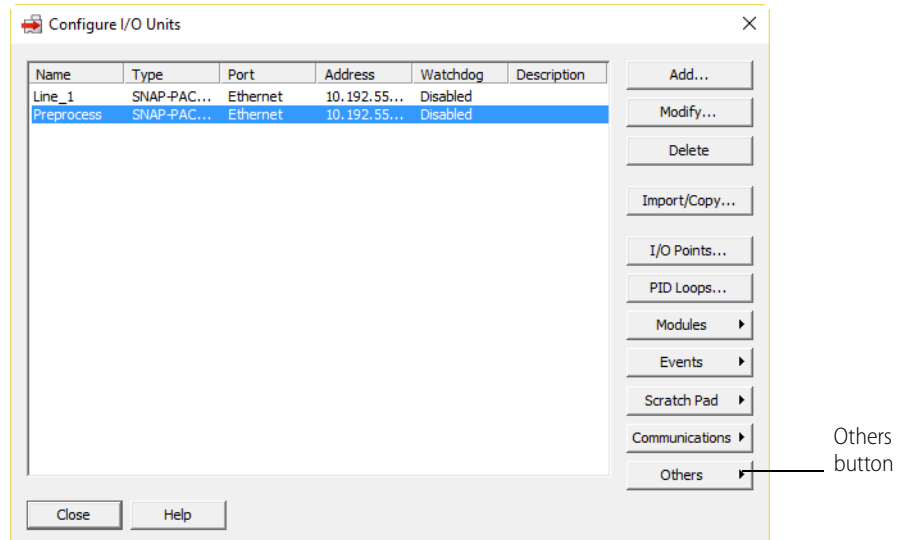

- In the configuration tree, right-click the name of the I/O unit on which you want to set the time and date and choose Configure from the pop-up menu.

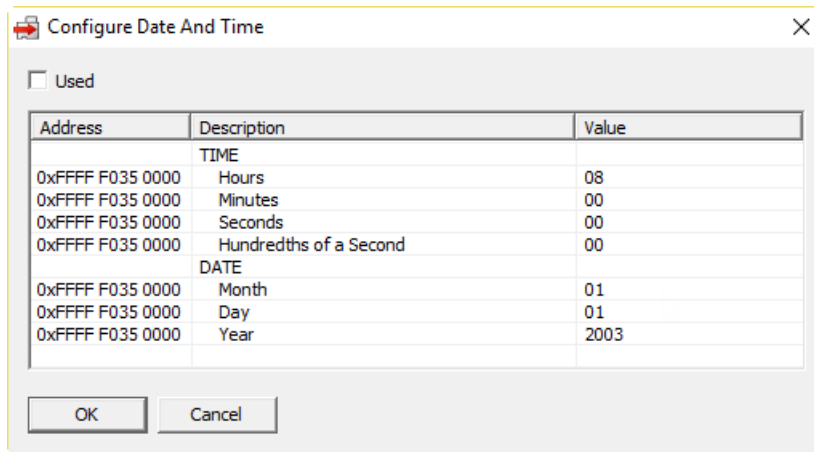

## CONFIGURING DIRECT COMMUNICATION TO SERIAL DEVICES

- Click the Others button and choose Date and Time from the pop-up menu.



- Click to put a check mark in the Used box. Enter the correct time and date values in the Value column. Click OK.
- Configure other optional functions, or return to the PAC Manager main window and click the Save button  to save the configuration file.

When you are ready to upload the configuration file to the I/O unit, see [“Sending Configuration Data to the I/O Unit” on page 83](#).

## CONFIGURING DIRECT COMMUNICATION TO SERIAL DEVICES

**PAC-S  
PAC-R  
UIO**

Applies to SNAP PAC and SNAP Ultimate controllers only (Requires firmware version 5.1c or higher on UIO).

Serial connectors are located on the top of SNAP PAC and SNAP Ultimate controllers. For the type, number, and function of serial ports on each device, see the device’s user guide. Depending on the device, these ports may be used for several purposes:

- Maintenance, such as loading new firmware (see [page 225](#)).
- Point-to-Point Protocol (PPP) communication via modem (see [page 139](#)).
- Connection to serial I/O units (PAC-S only).
- Sending or receiving data directly from a serial device, such as an RFID or barcode reader, a weigh scale, or any intelligent device with a serial port. For this use, communication occurs through PAC Control communication handles. (For more information, see “Communication Commands” in Chapter 10 of the [PAC Control User’s Guide](#) (form 1700).

*NOTE: This section shows you how to configure the controller to talk serially with devices directly connected to it. Serial devices attached to an I/O unit through serial communication modules on the rack are configured differently. See [page 60](#).*

Follow steps in the next section for on-the-rack controllers; see [page 136](#) for standalone controllers.

**PAC-R  
UIO**

### Configuring Serial Ports on an On-the-Rack Controller

Use these steps for SNAP PAC R-series and SNAP Ultimate I/O.

- If you are using a SNAP Ultimate brain, make sure it has firmware version 5.1c or higher. New firmware can be downloaded from our website, [www.opto22.com](http://www.opto22.com).
- In PAC Manager, click the Open button  (or in the menu bar, click File > Open).



3. In the Open Tag Database dialog box, navigate to the configuration file and double-click it to open it.
4. In the configuration tree, right-click the name of the I/O unit on which you want to configure direct serial communications and choose Configure from the pop-up menu.

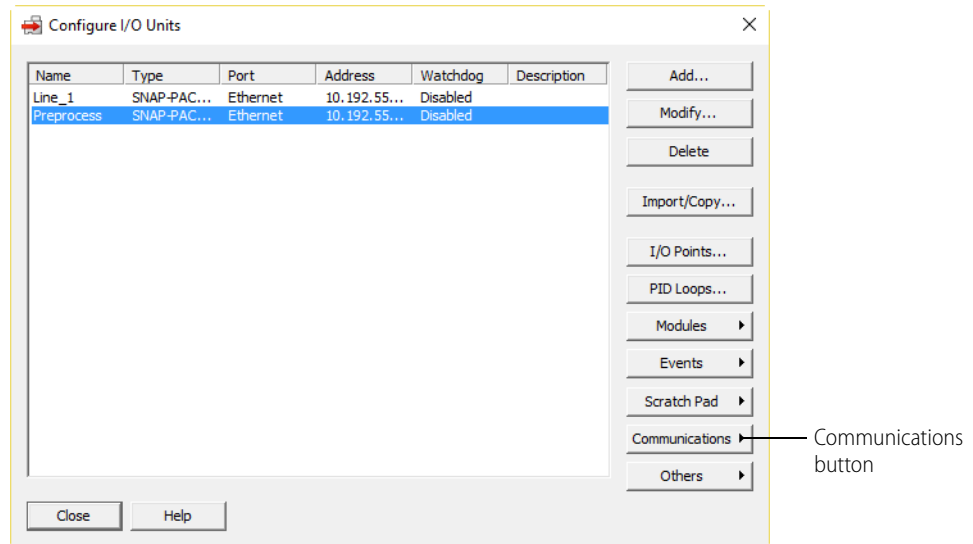

5. Click the Communications button and choose Communication Port Control from the pop-up menu.

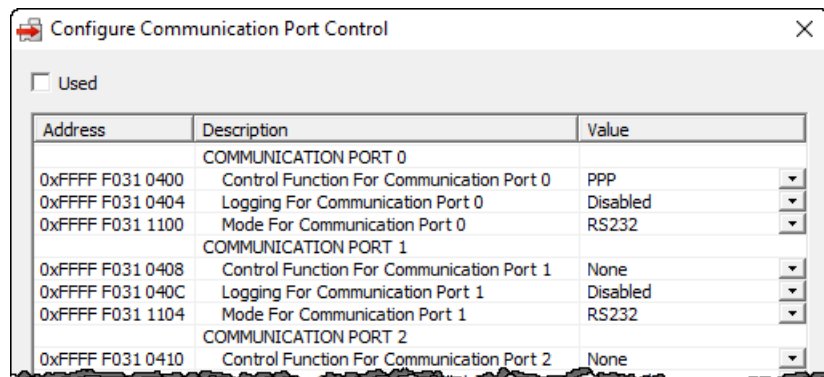

Because a configuration file could be built for any controller or brain PAC Manager supports, this window shows the possible ports and settings for all devices. Only a few apply to R-series PACs.

6. If there is no check mark in the Used box, click the box to place a check mark there. Ports shown in the window are as follows:
  - Port 0 = RS-232 connector on controller's top
  - Ports 1, 2, and 3 = Not used on the R-series controller
7. If Port 0 is used for modem communication, do the following:
  - a. In the Value field for Control Function for Communication Port 0, choose PPP from the drop-down list.
  - b. In the Logging for Communication Port field, leave logging Disabled unless you are troubleshooting serial communication (see [page 253](#)).

*NOTE: Logging adds significant overhead to serial communication; do not enable it unless you need to.*
8. If Port 0 is directly connected to a serial device, do the following:
  - a. In the Control Function for Communication Port 0 value field, choose None from the drop-down list.

- b. In the Logging for Communication Port field, leave the value field set to Disabled.  
Although you can use this log file for troubleshooting, when the control function is set to None, the log file logs only characters received by the PAC Control strategy. It is better to have PAC Control log the data rather than using the log file. The log file adds significant overhead to communication. (For more about the log file, see [page 253](#).)
  - c. In the Mode for Communication Port 0 field, leave the value set to RS232. (The R-series controller does not support RS-485.)
9. When you have finished configuring the port, click OK.
  10. Configure other optional functions, or return to the PAC Manager main window and click the Save button  to save the configuration file.

When you are ready to upload the configuration file to the I/O unit, see [“Sending Configuration Data to the I/O Unit” on page 83](#).

**PAC-S**

**Configuring Serial Ports on a Standalone Controller**

These steps apply to SNAP PAC S-series controllers.

1. In the PAC Manager main window, click the Inspect button  .  
The Inspect window opens.
  - If you haven’t used the Inspect window before, no data is displayed in the Status Read pane.
  - If you *have* used the Inspect window before, the last device you inspected is shown in the Device Name field, and current Status Read information appears in the window.
  - If you have configured other devices, they are listed in alphabetical order in the drop-down list.

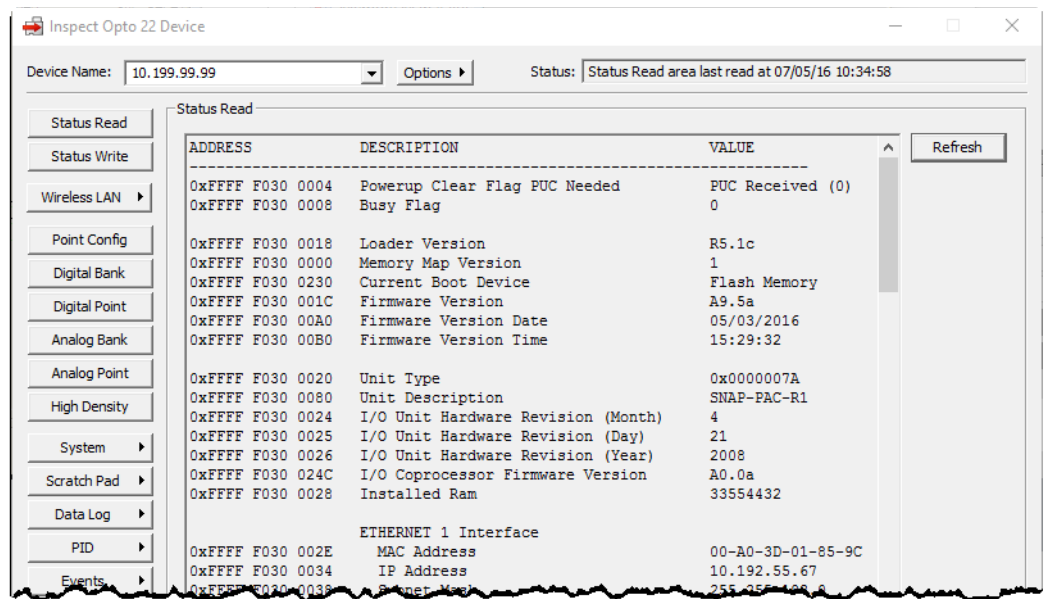

- If you have configured six or more devices, the Inspect window provides two additional time-saving features: Next and Back navigation buttons (to navigate back and forth through the alphabetized list

of devices), and a list of the five most recently inspected devices (displayed at the top of the drop-down list).

Next and Back navigation buttons and Most Recently Used list are displayed when you have six or more devices configured.

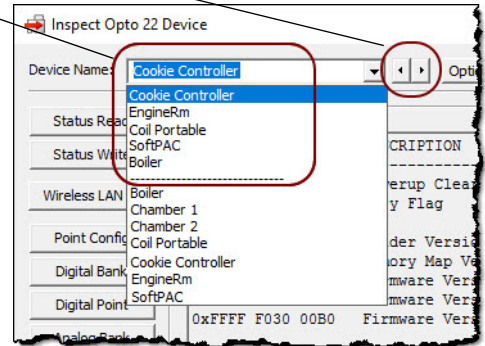

- In the Device Name field, type the name (or IP address) of the controller (or choose it from the drop-down list). Click Communications and choose Communication Port Control from the submenu.

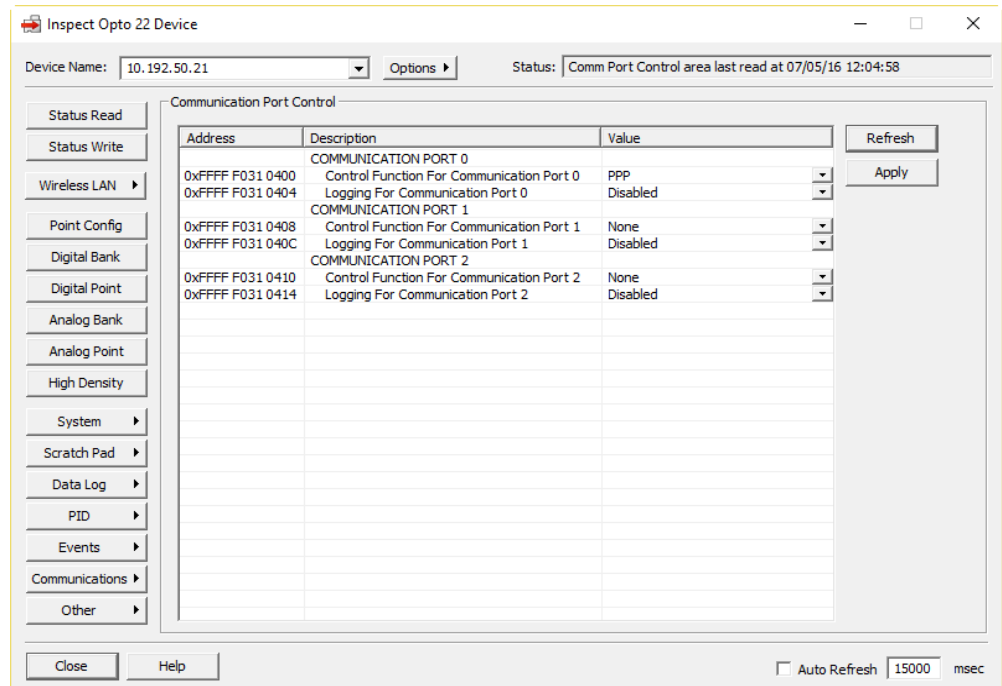

The Inspect window shows the ports and features that apply to the controller you’re inspecting. The example above is for a SNAP-PAC-S2, which has four ports. The following table shows how ports are labeled on the top covers of S1 and S2 controllers.

Port	= SNAP-PAC-S1	= SNAP-PAC-S2
0	S0	Serial 0
1	S1	Serial 1
2	S2	Serial 2

Port	= SNAP-PAC-S1	= SNAP-PAC-S2
3	--	Serial 3

3. If you are using a modem, do the following:
  - a. In the Control Function for Communication Port field for the port the modem is attached to, choose PPP from the drop-down list. Note that the lowest numbered port with PPP function configured is the only port that can be used for PPP. See [page 139](#) for more on setting up PPP.
  - b. In the Logging for Communication Port field, leave logging Disabled unless you are troubleshooting serial communication (see [page 253](#)). Logging adds significant overhead to serial communication; do not enable it unless you need to.
4. If you are using ports on a PAC-S2 to connect to serial I/O units, do the following for each port:
  - a. In the Control Function for Communication Port value field, choose None from the drop-down list.
  - b. In the Mode for Communication value field, choose the connection type, termination, and bias from the drop-down list.
  - c. In the Logging for Communication Port field, leave the value field set to Disabled.  
Although you can use this log file for troubleshooting, when the control function is set to None, the log file logs only characters received by the PAC Control strategy. It is better to have PAC Control log the data rather than using the log file. The log file adds significant overhead to communication. (For more about the log file, see [page 253](#).)
5. For each port that is directly connected to a serial device, do the following:
  - a. In the Control Function for Communication Port value field, choose None from the drop-down list.
  - b. In the Logging for Communication Port field, leave the value field set to Disabled.  
Although you can use this log file for troubleshooting, when the control function is set to None, the log file logs only characters received by the PAC Control strategy. It is better to have PAC Control log the data rather than using the log file. The log file adds significant overhead to communication. (See [page 253](#).)
  - c. (PAC-S2 only) In the Mode for Communication value field, choose the connection type, termination, and bias from the drop-down list.
6. When you have finished configuring the ports, click Apply.  
Configuration data is sent to the controller.

- Click the Status Write button on the left side of the Inspect window. In the Operation Command list, highlight Store configuration to flash.

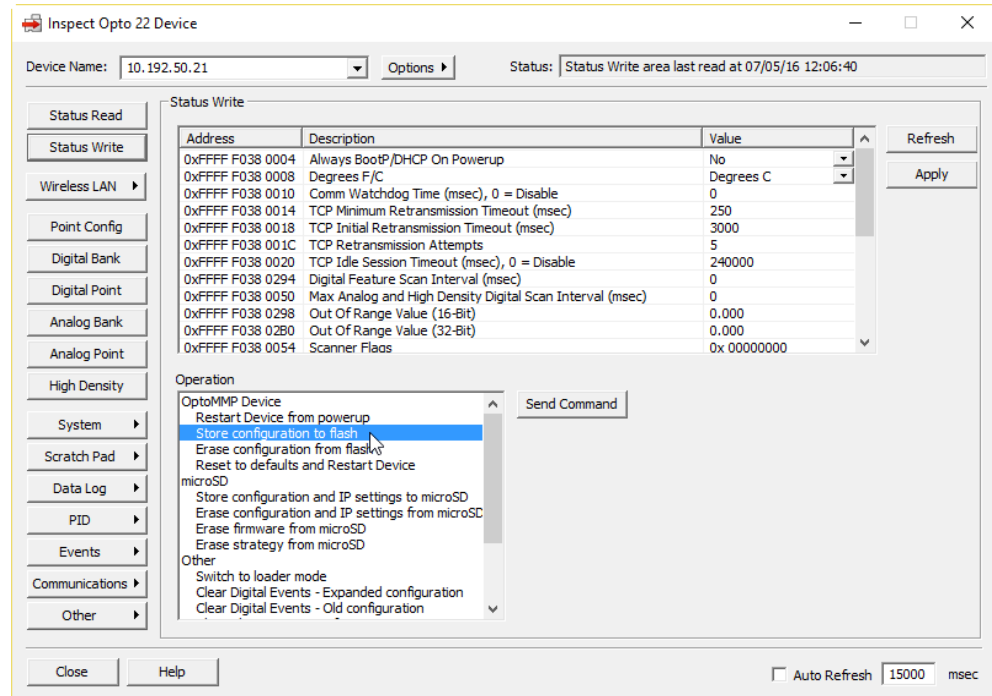

- Click Send Command.  
The port configuration data is stored to flash memory and a Success message appears.

## CONFIGURING PPP

**PAC-R  
EB  
UIO  
EIO**

Use this section only if you have SNAP PAC, SNAP Ultimate, or SNAP Ethernet I/O units installed at remote locations or in other places where an Ethernet network is not available, and you are using modems to communicate between the device and a computer. You can set up communication so that the device can dial in to a computer, so that computers can dial into the device, or both.

*NOTE: If you are using PPP with a SNAP PAC S-series controller, see instructions in the controller user's guide.*

(A SNAP Ultimate I/O unit is shown in the following examples.)

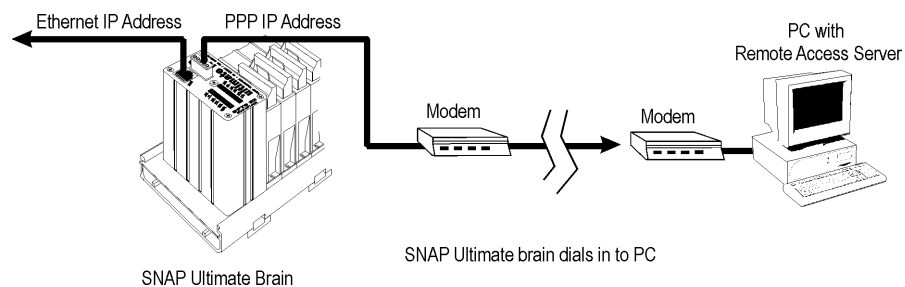

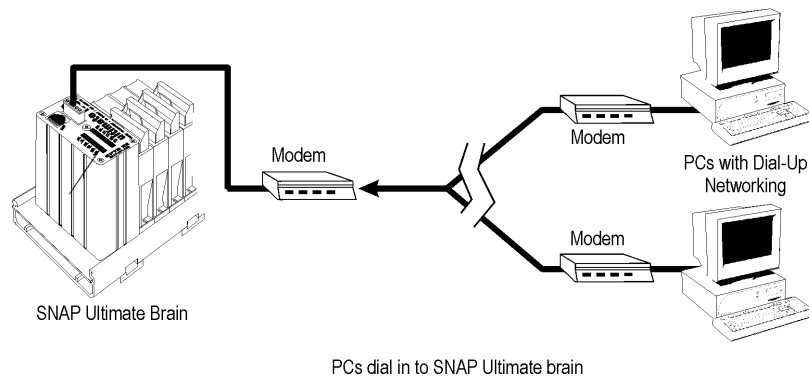

*IMPORTANT: After you have followed the steps in this section to configure PPP on the I/O unit, see the I/O unit's user's guide for information on attaching the modem to the system and setting up Windows dial-up networking or remote access server on the computer.*

PAC-R  
EB  
UIO  
EIO

### Configuring PPP on the I/O Unit

1. In the PAC Manager main window, click the Open button  or choose File > Open.
2. In the Open Tag Database dialog box, navigate to the configuration file and double-click it to open it.

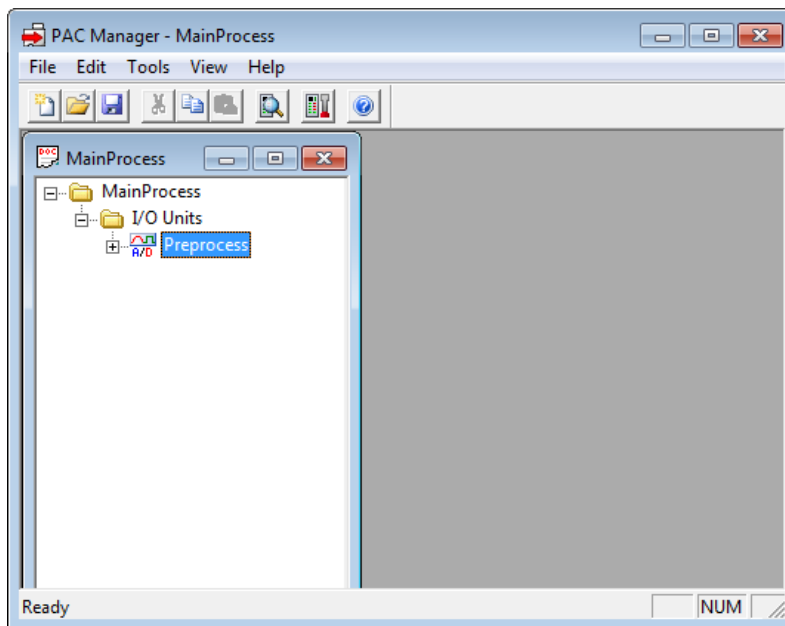

- In the configuration tree, right-click the name of the I/O unit on which you want to set up PPP and choose Configure from the pop-up menu.

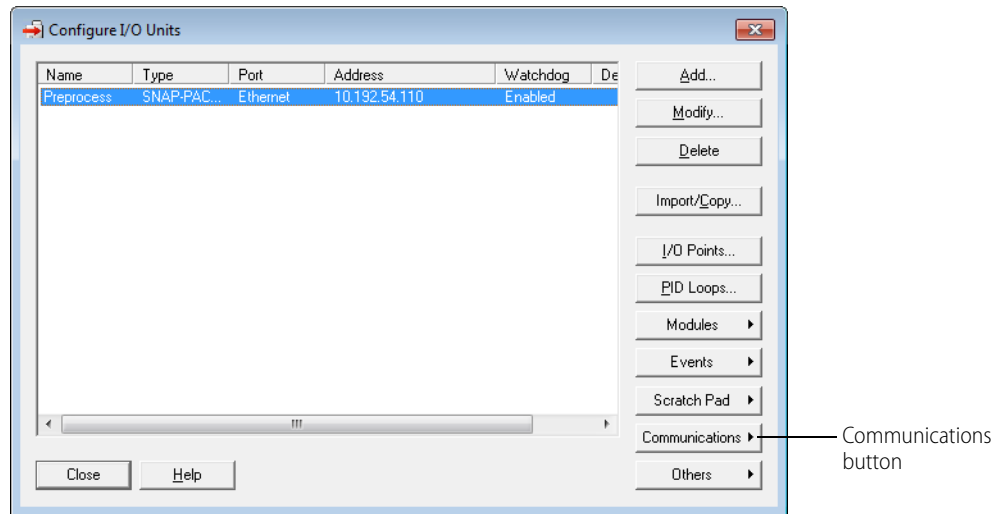

- Make sure the correct I/O unit is highlighted in the list. Click the Communications button and choose PPP from the pop-up menu.

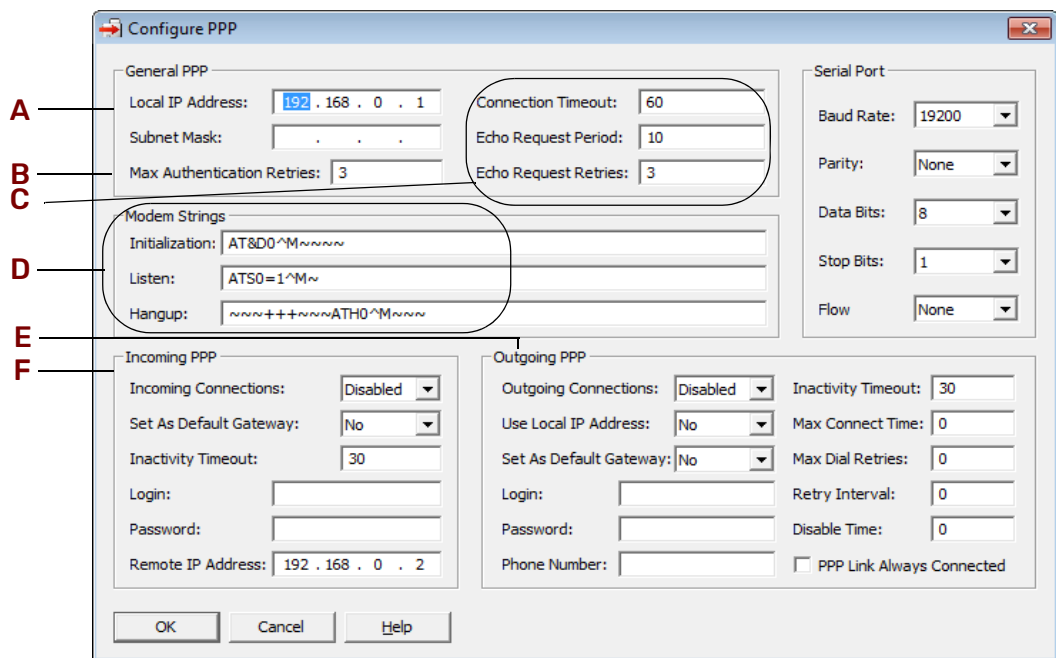

- Complete the fields as follows:

**A—Local IP Address.** Enter the Local IP Address for the PPP interface on the I/O unit. Enter the local Subnet Mask only if you are using classless IP addressing. If you are not using classless IP addressing, leave the Subnet Mask at zero, and the I/O unit will calculate the subnet mask.

*IMPORTANT: The network address for the PPP interface must be different from the network ID for the Ethernet interface. (The network address is obtained by ANDing the IP address and the subnet mask.)*

**B—Max Authentication Retries.** Enter the maximum number of times a login/password combination can be retried.

**C—Connection Timeout and Echo Request.** Change these values if necessary to establish and maintain the connection.

**D—Modem Initialization String.** Change the modem initialization string, listen string, and hangup string if necessary. Make sure you use the setting to ignore DTR signal in the modem initialization string:

The default modem initialization string is `AT&D0^M~~~~`

Consult the command reference that came with your modem to determine the correct initialization command strings. A sample modem initialization string might look like this:

```
AT&F^M~~~AT&D0&K0^M~~~AT&W0^M~~~AT&Y0^M~~~
```

The `&F` command sets the modem back to factory defaults. The `^M` tells the Ethernet I/O unit to insert a carriage return. The `~` tells it to insert a 500ms pause. The `&W0` writes the current settings to NVRAM profile 0 on the modem. The `&Y0` instructs the modem to use NVRAM profile 0 after resetting.

This initialization string is just a sample; command strings for your modem may differ.

**E—Outgoing PPP.** If the I/O unit will send outgoing calls, complete the Outgoing PPP section:

- Choose Enabled from the drop-down list.
- In the Use Local IP Address field, choose Yes to have the I/O unit use the Local IP Address you entered for the PPP link; choose No to have the remote device assign the I/O unit an IP address for the PPP link. The default is No.
- If you want the I/O unit to use the device the I/O unit is calling as the default gateway for all communication, choose Yes for Set As Default Gateway. The default is No.
- Enter the Login and Password the I/O unit should use for authentication when it calls the remote device.
- In the Phone number field, enter the number the modem should dial for outgoing calls from the I/O unit.

Change the following fields if necessary:

- Inactivity Timeout—If the I/O unit sends no packets and receives no packets for this number of seconds after the PPP session is negotiated, the modem will hang up. The default is 30.
- Max Connect Time—The maximum amount of time in seconds an outgoing PPP connection can stay connected after successful negotiation. Default is zero, which disables the timer.
- Max Dial Retries—The number of times the I/O unit will redial if the first attempt fails. Default is zero.
- Retry Interval—The number of seconds the I/O unit will wait before trying to redial after the first attempt fails. Default is zero.
- Disable Time—If the maximum connect time or maximum number of retries has been reached, the outgoing PPP dialer waits this number of seconds before doing anything. Default is zero.
- PPP Link Always Connected—If you want outgoing PPP to always be connected, so there is no need for the I/O unit to dial out, check this box.

**F—Incoming PPP.** If the I/O unit will receive incoming calls via modem, complete the Incoming PPP section:

- Choose Enabled from the drop-down list so the modem will listen for incoming calls.
- If you want the I/O unit to use the device calling the I/O unit as the default gateway for all communication, choose Yes for Set As Default Gateway. The default is No.
- Change the Inactivity Timeout if necessary. The default is 30.
- Enter the Login and Password the I/O unit should accept for incoming calls.
- In the Remote IP Address field, enter the IP address the I/O unit should give to devices that dial into the I/O unit and ask for an address. This address must be on the same subnet as the local IP address.



- Enter a modem listen string to make sure the modem automatically answers calls. The default modem listen string is `ATS0=1^M~`, which instructs the modem to answer any incoming calls on the first ring. Again, refer to your modem's command reference for the correct listen string.
6. When all fields are correct, click OK.

*IMPORTANT: For the configuration to take effect, you must upload the configuration file to the I/O unit, save it to flash memory, and restart the I/O unit.*

*NOTE: On a SNAP PAC R-series or SNAP Ultimate I/O unit, if the serial port you are using for PPP was previously used for a direct connection with a serial device, you must use PAC Manager's Inspect window to reset the port configuration from None to PPP. See [page 134](#) for more information.*

7. Configure other optional functions, or return to the PAC Manager main window and click the Save button  to save the configuration file.

When you are ready to upload the configuration file to the I/O unit, see [“Sending Configuration Data to the I/O Unit” on page 83](#). For information on attaching the modem to the system and setting up Windows dial-up networking or a remote access server, see the [SNAP Ethernet-Based I/O Units User's Guide](#) (form 1460) or the [SNAP PAC R-Series Controller User's Guide](#) (form 1595).



# 4: Setting Up Events and Reactions

## INTRODUCTION

PAC-R  
EB  
SB  
UIO  
EIO

Events and reactions are automatic responses to conditions monitored by SNAP PAC, SNAP Ultimate, and SNAP Ethernet I/O units. (E1, E2, and SNAP Simple I/O units do not support this feature.)

The monitored conditions, called events, and the responses to them, called reactions, can be simple or complex. An example of a simple event/reaction is turning on a fan in response to a rise in temperature. Complex event/reactions may involve multiple events and multiple reactions, with a time delay in between. For example, you could set up a temperature limit as an event that triggers a warning light, and a higher temperature limit as an event that sets off an audible alarm and sends an email message.

*CAUTION: Event/reactions you set up using these instructions in this chapter operate on the I/O side of a SNAP PAC R-series or SNAP Ultimate controller, independently of any PAC Control strategy running on the processor's control side. If you are using PAC Control with a SNAP PAC R-series or SNAP Ultimate I/O system, do not use this chapter. Instead, use the flowchart logic in the PAC Control strategy to handle reactions to events. The only reason you might set up event/reactions that operate independently on the I/O side of the controller would be a need for very fast reactions. If that is the case, be very careful that the event/reactions you set up do not conflict with PAC Control logic.*

The chapter introduces you to the Scratch Pad and other basic event/reaction concepts. It also shows you how to use PAC Manager to configure the following:

- Digital event/reactions (see [page 150](#))
- Alarm event/reactions (see [page 156](#))
- Serial or Wiegand event/reactions (see [page 159](#))
- Event messages (see [page 161](#))

## EVENT/REACTION CONCEPTS

This section describes using the Scratch Pad to track events and alarms, and types of events, alarms, and reactions.

PAC-S  
PAC-R  
SoftP  
EB  
SB  
UIO  
EIO

### The Scratch Pad

Event/reactions are available on SNAP PAC R-series, SNAP PAC EB and SB brains, SNAP Ultimate, and SNAP Ethernet I/O units. SNAP Simple I/O units and E1 and E2 brain boards do not have event/reaction capability.

*CAUTION: Event/reactions occur on the I/O side of a SNAP PAC R-series or SNAP Ultimate controller, independently of any PAC Control strategy running on the control side. If you are using PAC Control, it is best to use flowchart logic to handle reactions to events. If you do set up event/reactions, be very careful that they do not conflict with PAC Control logic.*

*groov* I/O units, *groov* RIO modules, SNAP PAC S-series and SNAP-LCE standalone controllers, SNAP PAC R-series and SNAP Ultimate on-the-rack controllers, and SNAP PAC and SNAP Ethernet brains contain Scratch Pad areas within their memory maps. (SNAP Simple brains and E1 and E2 brain boards do not contain a Scratch Pad.) Scratch Pad areas can be used for two main purposes:

- As a place to hold data being transferred from one peer to another on the network (*groov* EPIC, *groov* RIO, SNAP PAC S-series and R-series, SNAP-LCE, and SNAP Ultimate only)
- As a virtual notebook for keeping track of events and alarms (SNAP PAC R-series, SNAP PAC brains, SNAP Ultimate, and SNAP Ethernet only)

The Scratch Pad is user-defined, meaning that you define and use its addresses to fit your needs, and you can redefine them whenever necessary. The Scratch Pad area includes up to four sections, depending on device type, to accommodate different types of data: bits, strings, floats, and integers.

- The Scratch Pad bits section is a 64-bit mask.
- The Scratch Pad strings section is a table of 64 elements. Each element can hold 128 characters or 128 bytes of binary data.
- The Scratch Pad float section is a table of 10,240 elements; each float is four bytes.
- The Scratch Pad 32-bit integer section is also a table of 10,240 four-byte elements.
- The Scratch Pad 64-bit integer section is a table of 1024 eight-byte elements.

*NOTE: Scratch Pad float and 32-bit integer tables are not made up of contiguous addresses in the memory map; each table is in two address sections. You won't notice this if you are using PAC Control Scratch Pad commands, but if you are addressing these tables in another application, check the memory map appendix in the [OptoMMP Protocol Guide](#) to make sure you have the correct addresses for the table elements you want.*

Scratch Pad strings, floats, and integers are available for *groov* EPIC, *groov* RIO, SNAP PAC R-series, S-series, and SNAP Ultimate I/O and are primarily used to transfer data from one peer to another on the network. For more information on using the Scratch Pad in this way, see "I/O Units—Scratch Pad Commands" in Chapter 10 of the PAC Control User's Guide. (For SNAP, you can also use PAC Manager for one-time reads and writes.)

Scratch Pad bits are available for both standalone and on-the-rack controllers, *groov* RIO modules, and SNAP Ethernet I/O units. Controllers, *groov* RIO, and Ultimate I/O units usually use them in the same way as strings, floats, and integers—they're just another data format—but in Ethernet I/O units, Scratch Pad bits are primarily used for tracking events and alarms.

PR1  
PAC-R  
EB  
SB  
UIO  
EIO

### Using Scratch Pad Bits for Events and Alarms

When Scratch Pad bits are used to track events and alarms, the 64 bits in the mask do not represent channel numbers. Instead, they represent whatever you decide they should be. For example, you might decide that bit 1 in the Scratch Pad will indicate a temperature level in Vat #12 (if the temperature reaches 48 °C, bit 1 is turned on). Bit 2 might indicate the status of Pump A (if the pump is off, the bit is off; if the pump is on, the bit is on).

Because you can use Scratch Pad bits to keep track of events and alarms, you can set up reactions based on a variety of conditions. In the example above, you could set up a reaction on an EB brain that sends a stream packet if bit 1 is on and bit 2 is off.

#### Cascading Events, Alarms, and Reactions

Scratch Pad bits are really a way to set up cascading events and reactions (that is, a series of events and reactions dependent on each other). For example, the first event in the cascade could be the temperature in Vat #12 reaching 40 degrees, and the reaction to it is setting Scratch Pad bit 1. The second event in the cascade is that Scratch Pad bit #1 is set, and the reaction to that is some other action. A cascade of any number of events and reactions can be configured, as needed.

## USING EVENT/REACTIONS

(Does not apply to *groov* I/O units.) Event/reactions are available on SNAP PAC R-series, SNAP PAC EB and SB brains, SNAP Ultimate, and SNAP Ethernet I/O units. SNAP Simple I/O units and E1 and E2 brain boards do not have event/reaction capability.

**CAUTION:** Event/reactions occur on the I/O side of a SNAP PAC R-series or SNAP Ultimate controller, independently of any PAC Control strategy running on the control side. If you are using PAC Control, it is best to use flowchart logic to handle reactions to events. If you do set up event/reactions, be very careful that they do not conflict with PAC Control logic.

PAC-R  
EB  
SB  
UIO  
EIO

### Types of Events, Alarms, and Reactions

*NOTE: groov I/O units and SB brains do not support serial events and reactions nor reactions requiring an Ethernet network, such as sending email.*

The event or reaction can consist of one or a combination of the following. The reaction can take place immediately or after a delay.

#### Events:

- On/off state of a digital channel on a 4-channel module
- State of on-latch or off-latch for a digital channel on a 4-channel module
- On/off state of a digital channel on an HDD (high-density digital) module
- State of an on-latch or off-latch for a digital channel on an HDD module
- High or low value of an analog channel (in engineering units)
- Number on a digital counter or high or low number on a quadrature counter
- Analog channel value or quadrature counter that is outside allowable range
- State of a bit in the Scratch Pad bits area
- State of a bit in the Scratch Pad integer 64 area
- Specific string received by a serial module

#### Reactions:

- Turn on/off digital channel
- Clear on-latch or off-latch
- Copy data from one memmap location to another
- Log data
- Turn on or off a bit in the Scratch Pad bits area
- Turn on or off a bit in the Scratch Pad integer 64 area
- Send a stream packet
- Send an email message
- Send a string through a serial module to a serial device
- Send an SNMP trap

#### Effect of Firmware on Events and Reactions

The following table shows the types of events and reactions available, depending on your processor and the SNAP PAC firmware version you are using. The event or reaction can consist of one or a combination of the following. The reaction can take place immediately or after a delay.

	PAC Firmware $\geq$ 8.1		PAC Firmware $\leq$ 8.0	
	PAC-R, EB	SB	PAC-R, EB	UIO, EIO
Events				

	PAC Firmware $\geq$ 8.1		PAC Firmware $\leq$ 8.0	
	PAC-R, EB	SB	PAC-R, EB	UIO, EIO
On/off state of digital channel on 4-channel module	•	•	•	•
State of on-latch or off-latch for digital channel on 4-ch mod	•	•		
On/off state of digital channel on HDD module	•	•		
State of on-latch or off-latch for digital channel on HDD mod	•	•		
High or low value of analog channel (in EU)	•	•	•	•
Number on a digital counter or high or low number on quadrature counter	•	•	•	•
Analog channel value or quadrature counter that is outside allowable range	•	•	•	•
State of a bit in the Scratch Pad bits area	•	•	•	•
State of a bit in the Scratch Pad integer 64 area	•	•		
Specific string received by serial module	•		•	•
<b>Reactions</b>				
Turn on/off digital channel on 4-channel module	•	•	•	•
Turn on/off digital channel on HDD module	•	•		
Clear on-latch or off-latch on 4-channel or HDD module	•	•		
Copy data from one memmap location to another	•	•	•	•
Log data	•	•	•	•
Turn on or off a bit in the Scratch Pad bits area	•	•	•	•
Turn on or off a bit in the Scratch Pad integer 64 area	•	•		
Send stream packet	•		•	•
Send email message	•		•	•
Send string through a serial module to a serial device	•		•	•
Send SNMP trap	•		•	•

The following table shows the number and type of events available, depending on the processor and the firmware version.

Event Type	PAC Firmware $\geq$ 8.1		PAC Firmware $\leq$ 8.0	
	PAC-R, EB	SB	PAC-R, EB	UIO, EIO
Digital events—Expanded (formerly called Timers)	512	512	64	64
Digital events—Old	128	128	128	128
Alarm events	64	64	64	64
Serial events	32	n/a	32	32

Note that the memory map section formerly called Timers, which provided digital events with a delay between an event and the reaction to it, has been expanded in firmware 8.1 to include additional options such as latches and HDD modules. All new digital events should be configured in Digital Events - Expanded to take advantage of the new flexibility.

Digital events you already configured still exist in Digital Events - Old. Timers you already configured still exist in Digital Events - Expanded.

The following table details steps for configuring events and reactions. See page references for more. A flowchart following the table summarizes Alarm and Serial event and reaction configuration.

Event	Reaction	Configuration Steps	See
If digital point is on/off	Turn digital point on/off (on same I/O unit)	Configure Digital Events - Expanded	<a href="#">page 150</a>
	Turn digital point on/off (on different I/O unit) OR Log data OR Copy memory map data OR Send message (stream, e-mail, serial, or SNMP trap).	1. Configure Digital Events - Expanded—set Scratch Pad bit 2. (Email message only) Configure Email (Streaming only) Configure Streaming (SNMP only) Configure SNMP 3. (Except data logging) Configure Event Messages—send message or data (Data logging) Configure Data Logging and configure Email (optional)	<a href="#">page 150</a> <a href="#">page 116</a> <a href="#">page 120</a> <a href="#">page 112</a> <a href="#">page 108</a> <a href="#">page 103</a> <a href="#">page 116</a>
If analog point value (Engineering Units) goes above or below a specified value OR If digital counter reaches a specified value	Turn digital point on/off (on same I/O unit).	1. Configure Alarm Events (high alarm or low alarm)—set Scratch Pad bit 2. Configure Digital Events - Expanded—turn on/off point	<a href="#">page 156</a> <a href="#">page 150</a>
	Turn digital point on/off (on different I/O unit) OR Copy memory map data OR Log data OR Send message (stream, email, serial, or SNMP trap).	1. Configure Alarm Events (high alarm or low alarm)—set Scratch Pad bit 2. (Optional for a delay) Configure Digital Events - Expanded— use the alarm Scratch Pad bit as the event, set the time delay, and set a Scratch Pad bit after the delay 3. (Email message only) Configure Email (Streaming only) Configure Streaming (SNMP only) Configure SNMP 4. (Except data logging) Configure Event Messages—send message or data based on alarm bit or delay bit (Data logging) Configure Data Logging based on alarm bit or delay bit and configure Email (optional)	<a href="#">page 156</a> <a href="#">page 150</a> <a href="#">page 116</a> <a href="#">page 120</a> <a href="#">page 112</a> <a href="#">page 108</a> <a href="#">page 103</a> <a href="#">page 116</a>
If analog point value (Engineering Units) or quadrature counter goes outside an allowable range	Turn digital point on/off (on same I/O unit)	1. Configure Alarm Events (deviation alarm)—set Scratch Pad bit 2. Configure Digital Events - Expanded—turn on/off point	<a href="#">page 156</a> <a href="#">page 150</a>
	Turn digital point on/off (on different I/O unit) OR Copy memory map data OR Log data OR Send message (stream, email, serial, or SNMP trap).	1. Configure Alarm Events (deviation alarm)—set Scratch Pad bit 2. (Optional for a delay) Configure Digital Events - Expanded— set time delay and set a Scratch Pad bit after the delay 3. (Email message only) Configure Email (Streaming only) Configure Streaming (SNMP only) Configure SNMP 4. (Except data logging) Configure Event Messages—send message or data immediately or based on delay bit (Data logging) Configure Data Logging immediately or based on delay bit and configure Email (optional)	<a href="#">page 156</a> <a href="#">page 150</a> <a href="#">page 116</a> <a href="#">page 120</a> <a href="#">page 112</a> <a href="#">page 108</a> <a href="#">page 103</a> <a href="#">page 116</a>

Event	Reaction	Configuration Steps	See
If a specific string is received by a serial module	Turn digital point on/off (on same I/O unit)	<ol style="list-style-type: none"> <li>1. Configure Serial Events—set Scratch Pad bit</li> <li>2. Configure Digital Events - Expanded—turn on/off point</li> </ol>	<a href="#">page 159</a> <a href="#">page 150</a>
	Send SNMP trap	<ol style="list-style-type: none"> <li>1. Configure Serial Events—set Scratch Pad bit</li> <li>2. (Optional for a delay) Configure Digital Events - Expanded— set time delay and set a Scratch Pad bit after the delay</li> <li>3. Configure SNMP</li> <li>4. Configure Event Messages—send trap immediately or based on delay bit</li> </ol>	<a href="#">page 159</a> <a href="#">page 150</a> <a href="#">page 112</a> <a href="#">page 108</a>
	Send one-time email	<ol style="list-style-type: none"> <li>1. Configure Serial Events—send email</li> <li>2. Configure Email</li> </ol>	<a href="#">page 159</a>
	Turn digital point on/off (on different I/O unit) OR Copy memory map data OR Log data OR Send message (stream, serial, or multiple emails)	<ol style="list-style-type: none"> <li>1. Configure Serial Events—set Scratch Pad bit</li> <li>2. (Optional for a delay) Configure Digital Events - Expanded— set time delay and set a Scratch Pad bit after the delay</li> <li>3. (Email message only) Configure Email (Streaming only) Configure Streaming</li> <li>4. (Except data logging) Configure Event Messages—send message or data immediately or based on delay bit (Data logging) Configure Data Logging immediately or based on delay bit and configure Email (optional)</li> </ol>	<a href="#">page 159</a> <a href="#">page 150</a> <a href="#">page 116</a> <a href="#">page 120</a> <a href="#">page 108</a> <a href="#">page 103</a> <a href="#">page 116</a>

The following flowchart summarizes Alarm and Serial event and reaction configuration.

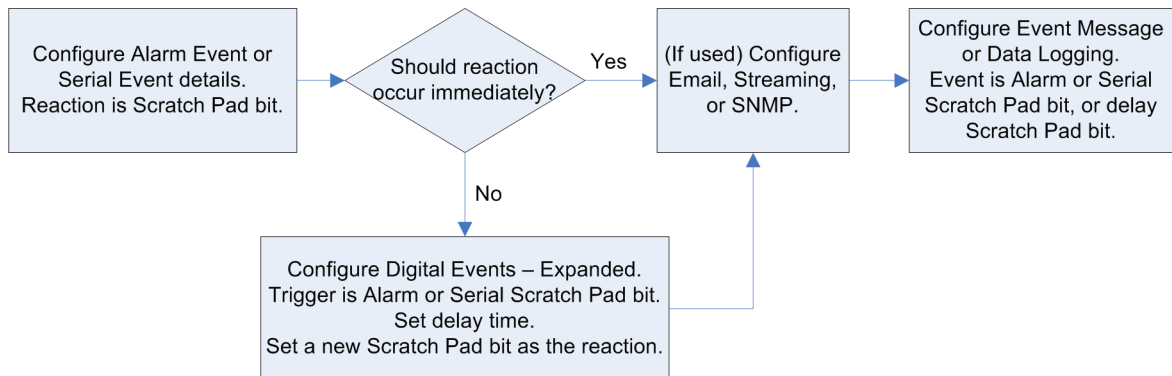

## CONFIGURING DIGITAL EVENTS AND REACTIONS

**PAC-R**  
**EB**  
**SB**  
**UIO**  
**EIO**

In a digital event, the I/O unit monitors one or more inputs, outputs, and Scratch Pad bits for a match to a specific pattern (the event). When the pattern is matched, the I/O unit reacts in a predetermined way. The reaction can turn digital points on or off and can also set bits in the Scratch Pad. You can configure up to 512 digital events and reactions for SNAP PAC controllers and brains, up to 128 for SNAP-ENET-D64 and SNAP-UP1-M64, and up to 64 for other SNAP Ultimate I/O controllers and SNAP Ethernet I/O brains.

Digital event/reactions can be as simple as turning on a light (reaction) when a door opens (event). They can also be very complex, depending on your needs. For example, suppose you need to monitor a critical group of switches. If switches 1, 2, and 3 are all off at once, you want to turn on an emergency light and sound an alarm. You can set up a digital event for the state of the three switches, and a reaction that automatically turns on the emergency light and alarm.

In addition to digital states, events can include alarm or other conditions noted in the Scratch Pad. For instance, to regulate the temperature of a room, you might set up an alarm event that turns on a bit in the



Scratch Pad when the temperature reaches 78° F (see “Configuring Alarms and Reactions” on page 156). Then you would set up a digital event/reaction to turn on a fan when that Scratch Pad bit is on.

*NOTE: If you want to turn on or off digital points that are located on a different I/O unit, you can do so by using the memory map copying feature. See “Copying Memory Map Data” on page 125 for details.*

### Digital Point and Scratch Pad Masks

Both events and reactions are in the form of a mask. Digital point masks represent 64 possible digital states; you choose whether these are point states or on-latch or off-latch states. Scratch Pad masks represent whatever you decide each bit should be. (Digital data options vary depending on your processor and firmware. See the tables on page 73.)

For each digital event/reaction, you set up two to eight masks: up to four for the event and up to four for the reaction.

**For the event:** The table below shows possible triggers for the event, in the form of four masks. You can configure only Trigger #1, only Trigger #2, or both. If you configure both, both must be true for the event to be true. Choose the trigger(s) you want to use; then set up the masks.

Trigger #1		Trigger #2	
On mask	Off mask	On mask	Off mask
Digital Point State	Digital Point State	Digital Point State	Digital Point State
Digital Point On Latch	Digital Point On Latch	Digital Point On Latch	Digital Point On Latch
Digital Point Off Latch	Digital Point Off Latch	Digital Point Off Latch	Digital Point Off Latch
HDD Point State	HDD Point State	HDD Point State	HDD Point State
HDD Point On Latch	HDD Point On Latch	HDD Point On Latch	HDD Point On Latch
HDD Point Off Latch	HDD Point Off Latch	HDD Point Off Latch	HDD Point Off Latch
Scratch Pad Bits	Scratch Pad Bits	Scratch Pad Bits	Scratch Pad Bits
Scratch Pad Integer 64	Scratch Pad Integer 64	Scratch Pad Integer 64	Scratch Pad Integer 64

**For the reaction:** This table shows possible reactions, again in the form of four masks. You can configure only Reaction #1, only Reaction #2, or both. When the event occurs, all configured reactions will take place. Choose the reaction(s) you want to occur, and then set up the masks.

Reaction #1		Reaction #2	
On mask	Off mask	On mask	Off mask
Digital Point States	Digital Point States	Digital Point States	Digital Point States
Clear Digital Point On/Off Latches	Clear Digital Point On/Off Latches	Clear Digital Point On/Off Latches	Clear Digital Point On/Off Latches
HDD Point States	HDD Point States	HDD Point States	HDD Point States
Clear HDD Point On/Off Latches	Clear HDD Point On/Off Latches	Clear HDD Point On/Off Latches	Clear HDD Point On/Off Latches
Scratch Pad Bits	Scratch Pad Bits	Scratch Pad Bits	Scratch Pad Bits
Scratch Pad Integer 64	Scratch Pad Integer 64	Scratch Pad Integer 64	Scratch Pad Integer 64

*NOTE: Trigger #1 does NOT control Reaction #1; Trigger #2 does not control Reaction #2. Instead, all the masks work as a group. All the event masks must be a match for the I/O unit to set the reaction(s), and if the event occurs, any and all reactions will be set. If it doesn't matter whether a specific point or bit is on or off, leave its value at zero in both the on mask and the off mask.*

When you configure events and reactions, the masks are in hex notation. If you are setting up a Digital On mask for points 0–7, for example, you might do so as follows:

Module position:	1				0			
Point number:	3	2	1	0	3	2	1	0
State:	On	–	On	On	–	–	–	On
Binary notation:	1	0	1	1	0	0	0	1

Hex notation: 

B	1
---	---

For more information on mask data format, see [page 218](#). See the following pages for a step-by-step example to set up event/reactions.

You can also configure the I/O unit to send a message as a reaction to digital events. See [page 108](#).

**How Digital Events Trigger Reactions**

Reactions to digital events can be level-triggered (occur continuously) or edge-triggered (occur once). The I/O unit continually checks the digital state to see if it matches the event, and the I/O unit sends the reaction as soon as the state matches the event. If you configure the reaction to occur continuously, the I/O unit continues to send the reaction until the state changes. If you configure it to occur once, the reaction is sent only once.

In either case, however, if the state changes so that it no longer matches the event, the I/O unit does NOT reverse the reaction.

**Example: Digital Event/Reaction**

For example, suppose you have set up an event/reaction to turn on a light when a door is open. As soon as the event occurs (the door opens), the I/O unit sends the reaction (turn on the light).

When the door is shut, the I/O unit stops turning on the light, but it does NOT turn the light off. To turn off the light when the door is shut, you need to set up a second event/reaction.

Suppose the input for the door’s status is on point 0 on the module in position 0, and the output for the light is on point 1 on the module in position 1. Here are the two event/reactions to turn on the light when the door is open, and turn off the light when the door is shut:

Event #0:	IF	Mod 0 Pt 0 (Door) is	OFF (Open)
Reaction #0:	THEN	Turn Mod 1 Pt 1 (Light)	ON

Event #1:	IF	Mod 0 Pt 0 (Door) is	ON (Closed)
Reaction #1:	THEN	Turn Mod 1 Pt 1 (Light)	OFF

Since this example is a simple one-to-one correspondence, it is pretty easy to set up.

1. If PAC Manager isn’t already open, start it. (For instructions, see the footnote on [page 16](#).)
2. Click the Open button  or choose File > Open.

3. In the Open Tag Database dialog box, navigate to the configuration file and double-click it to open it.

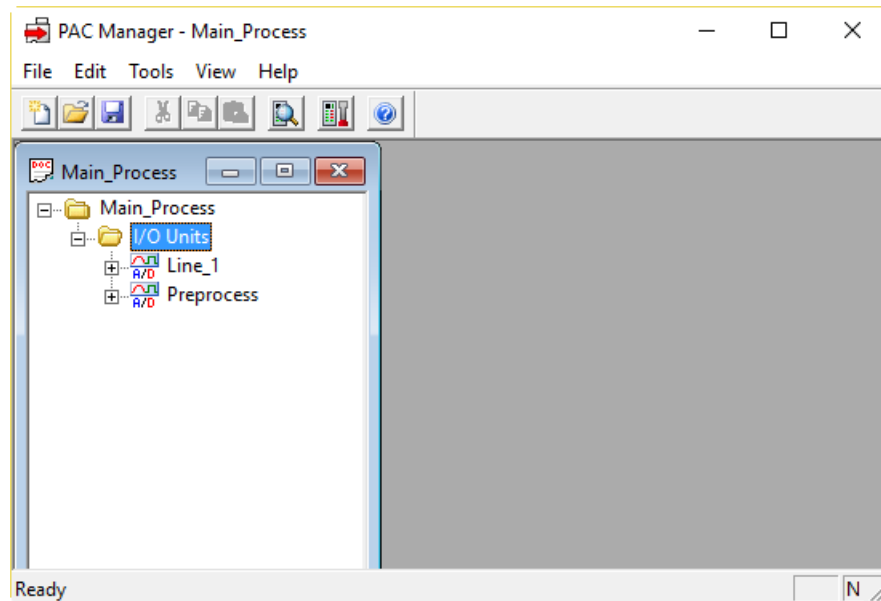

4. In the configuration tree, right-click the name of the I/O unit on which you want to set up digital events and choose Configure from the pop-up menu.

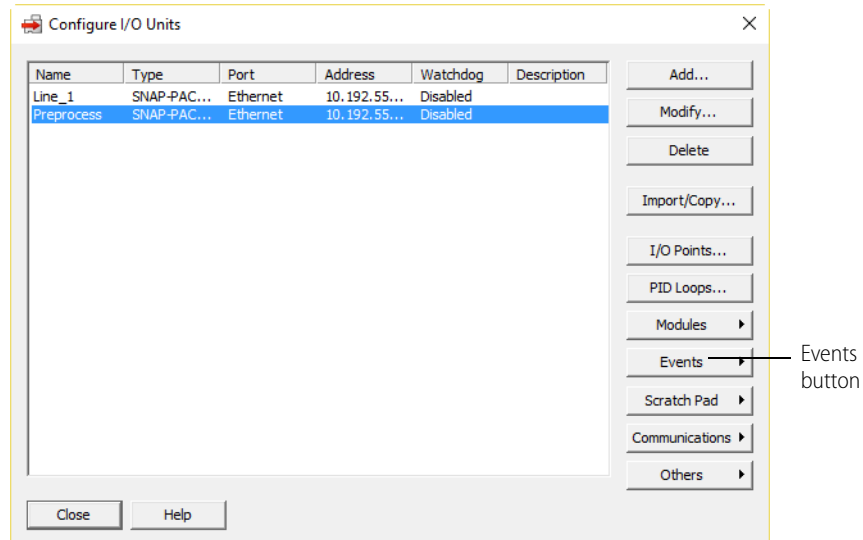

5. For processors with firmware 8.1 or higher, click the Events button and choose Digital Events - Expanded from the pop-up menu.  
If your processor has firmware 8.0 or lower, expanded digital events are not available; choose Digital Events - Old. Choices are more limited with older firmware; see tables on [page 73](#).

*IMPORTANT: If you configured digital events in a version of PAC Manager prior to 8.1, you will find them in Digital Events - Old. If you configured timed events in a PAC Manager version prior to 8.1, you'll see them here in Digital Events - Expanded.*

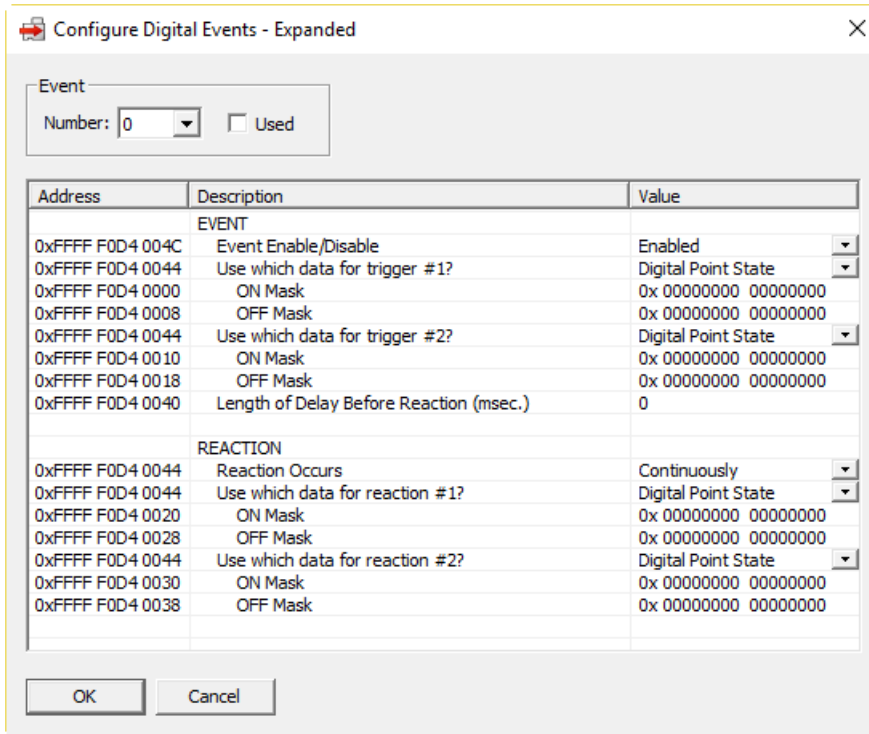

6. In the drop-down list, choose the lowest unused Event Number. Click to place a check mark in the Used box.

*NOTE: To reduce scanning time, the I/O unit stops scanning digital events when it reaches an unused event. Make sure you use event numbers in order, starting with the lowest.*

7. Configure the Event by clicking in the Value column and entering a value or choosing from the drop-down list.
  - a. Choose Enabled.
  - b. Choose which digital data to use as the trigger; in this example it is Digital Point State.
  - c. Leave the Digital ON mask all zeros. Enter the Digital OFF mask for the open door.

Remember that the masks are in hex notation. Here's how you might figure out the Digital ON mask to turn on the light:

Module position:	15				→	1				0			
Digital point:	3	2	1	0	→	3	2	1	0	3	2	1	0
State:	--	--	--	--	→	--	--	On	--	--	--	--	--
Binary notation:	0	0	0	0	→	0	0	1	0	0	0	0	0
Hex notation:	0				→	2				0			

You don't need to enter anything for Trigger #2, because the open door is the only dependency for this event.

- d. If you want a delay between the event and the reaction, enter the delay in milliseconds.
8. Configure the Reaction.
  - a. Choose whether the reaction should occur once or continuously; for this example, it's continuously.

- b. Choose the digital data and/or Scratch Pad bits to use for the reaction, and enter the masks. Here's how the Event and Reaction sections might appear for the door/light example.

The screenshot shows the 'Configure Digital Events - Expanded' dialog box with 'Event Number: 0' selected and the 'Used' checkbox checked. The table below shows the configuration for Event 0:

Address	Description	Value
EVENT		
0xFFFF F0D4 004C	Event Enable/Disable	Enabled
0xFFFF F0D4 0044	Use which data for trigger #1?	Digital Point State
0xFFFF F0D4 0000	ON Mask	0x 00000000 00000000
0xFFFF F0D4 0008	OFF Mask	0x 00000000 00000001
0xFFFF F0D4 0044	Use which data for trigger #2?	Digital Point State
0xFFFF F0D4 0010	ON Mask	0x 00000000 00000000
0xFFFF F0D4 0018	OFF Mask	0x 00000000 00000000
0xFFFF F0D4 0040	Length of Delay Before Reaction (msec.)	0
REACTION		
0xFFFF F0D4 0044	Reaction Occurs	Continuously
0xFFFF F0D4 0044	Use which data for reaction #1?	Digital Point State
0xFFFF F0D4 0020	ON Mask	0x 00000000 00000020
0xFFFF F0D4 0028	OFF Mask	0x 00000000 00000000
0xFFFF F0D4 0044	Use which data for reaction #2?	Digital Point State
0xFFFF F0D4 0030	ON Mask	0x 00000000 00000000
0xFFFF F0D4 0038	OFF Mask	0x 00000000 00000000

Callouts in the image explain the masks: 'Event: Digital OFF mask— door on mod 0 pt 0 is open.' (pointing to the OFF Mask value) and 'Reaction: Digital ON mask—turn on light at mod 1 pt 1.' (pointing to the ON Mask value for reaction #1).

9. Now choose Event Number 1 from the drop-down list and click Used. In the Event and Reaction sections, enter the Digital ON mask for the closed door and the Digital OFF mask to turn off the light.

The screenshot shows the 'Configure Digital Events - Expanded' dialog box with 'Event Number: 1' selected and the 'Used' checkbox checked. The table below shows the configuration for Event 1:

Address	Description	Value
EVENT		
0xFFFF F0D4 00CC	Event Enable/Disable	Enabled
0xFFFF F0D4 00C4	Use which data for trigger #1?	Digital Point State
0xFFFF F0D4 0080	ON Mask	0x 00000000 00000001
0xFFFF F0D4 0088	OFF Mask	0x 00000000 00000000
0xFFFF F0D4 00C4	Use which data for trigger #2?	Digital Point State
0xFFFF F0D4 0090	ON Mask	0x 00000000 00000000
0xFFFF F0D4 0098	OFF Mask	0x 00000000 00000000
0xFFFF F0D4 00C0	Length of Delay Before Reaction (msec.)	0
REACTION		
0xFFFF F0D4 00C4	Reaction Occurs	Continuously
0xFFFF F0D4 00C4	Use which data for reaction #1?	Digital Point State
0xFFFF F0D4 00A0	ON Mask	0x 00000000 00000000
0xFFFF F0D4 00A8	OFF Mask	0x 00000000 00000020
0xFFFF F0D4 00C4	Use which data for reaction #2?	Digital Point State
0xFFFF F0D4 00B0	ON Mask	0x 00000000 00000000
0xFFFF F0D4 00B8	OFF Mask	0x 00000000 00000000

Callouts in the image explain the masks: 'Event: Digital ON mask— door on mod 0 pt 0 is closed.' (pointing to the ON Mask value) and 'Reaction: Digital OFF mask—turn off light at mod 1 pt 1.' (pointing to the OFF Mask value for reaction #1).

10. Click OK.  
Both event/reactions are configured.

11. Configure other event/reactions, or return to the PAC Manager main window and click the Save button  to save the configuration file.

## CONFIGURING ALARMS AND REACTIONS

PAC-R  
EB  
SB  
UIO  
EIO

A reaction can also be set up as a response to an alarm. You can configure alarms for analog points or digital counters. For example, you could monitor the pressure in a tank and set up an alarm if it rises above a certain level, or you could trigger an alarm when a specific number of boxes on a conveyor have passed through a beam sensor. For each alarm, you configure a suitable reaction.

For analog points, alarms are based on the analog input value. For digital points, alarms are based on the counter value (applies to points on 4-channel digital modules only). For each point, you can configure any or all of the following alarms:

- **Deviation alarm**—sets a range on either side of the current value that is acceptable; beyond that range, the reaction occurs. For example, suppose you are monitoring temperature. If the current value is 80 and you set a deviation limit of 6, the reaction will not occur unless the value drops below 74 or rises above 86.

If you have an Alarm Event that is configured as a deviation alarm, in order to capture that an alarm occurred you need to set a scratch pad bit (such as bit 0) as the reaction of the alarm event. Also, you need to create another event, such as a Digital Event - Expanded, that triggers based on that scratch pad bit. The Digital Event would set a different scratch pad bit (such as bit 1) to be used for other logic or events. For example, digital event 0 sees set bit 0 and sets bit 1. Now bit one remains set until cleared. Set bit 1 can be used to start a timer that clears bit 1 when it expires. Bit 1 could also trigger an event message that requires acknowledgment.

*NOTE: When a reaction occurs, the deviation limit stays the same, but the value that set off the reaction becomes the new deviation value. In this example, if the temperature drops to 73, the reaction occurs. Six is still the deviation limit, but now 73 is the deviation value; another reaction will not occur unless the value drops below 67 or rises above 79.*

- **High-limit alarm**—sets a fixed upper limit. If the analog value or counter is higher than the high limit, the reaction occurs.
- **Low-limit alarm**—sets a fixed lower limit. If the analog value or counter is lower than the low limit, the reaction occurs.

### How Alarms Trigger Reactions

Reactions to alarms are edge-triggered, not level-triggered, and when the alarm state changes, the reaction is automatically reversed. The I/O unit sends the reaction just once, as soon as the alarm occurs (at the “edge” of the alarm). The I/O unit does not send the reaction again until the alarm occurs again. If the alarm stops, however, the I/O unit *reverses* the reaction.

For example, suppose you set up a high-limit alarm that turns on a Scratch Pad bit that will turn on a fan if the temperature goes over 70°. As soon as the alarm state occurs (the temperature goes over 70°), the I/O unit sends the reaction (turns on the bit to turn on the fan). If the temperature remains above 70°, the I/O unit does not continue to turn on the fan bit; the bit just stays on.

When the temperature falls back below the high limit (70° minus whatever deadband you have set), the I/O unit automatically reverses the reaction by turning the Scratch Pad bit off. (To turn the fan off, you would have to set up a reaction for the off bit, turning the fan off.)

Notice that the reaction and its reversal are absolute; they do not depend on the pre-alarm condition. For example, if the bit to turn on the fan was already on at the time the temperature rose above 70°, the reaction

would turn the bit on even though it was already on. When the temperature fell back below 70°, the I/O unit would not return the fan bit to its pre-alarm condition (on); it would turn the bit off.

#### Example: Alarms Event/Reaction

1. In the PAC Manager main window, with a configuration file open, right-click the name of the I/O unit on which you want to set up alarm events. Choose Configure from the pop-up menu.

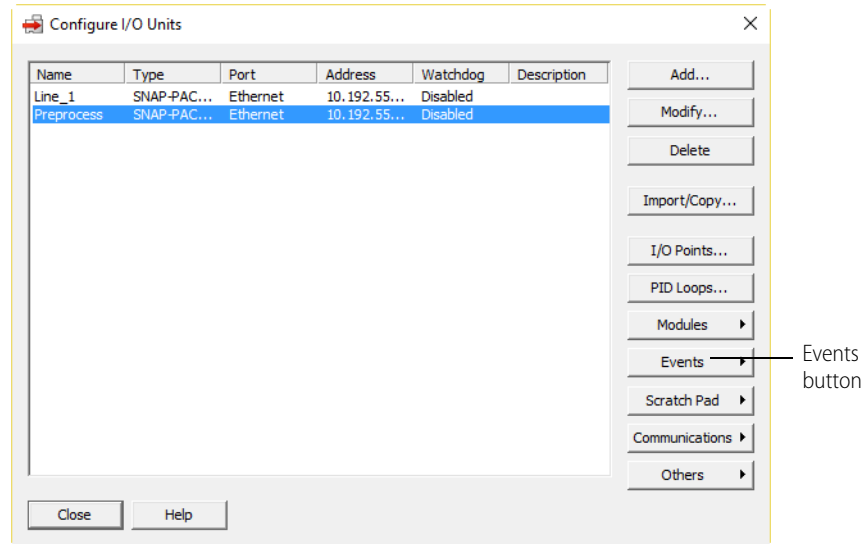

- Click the Events button and choose Alarm Events from the pop-up menu.

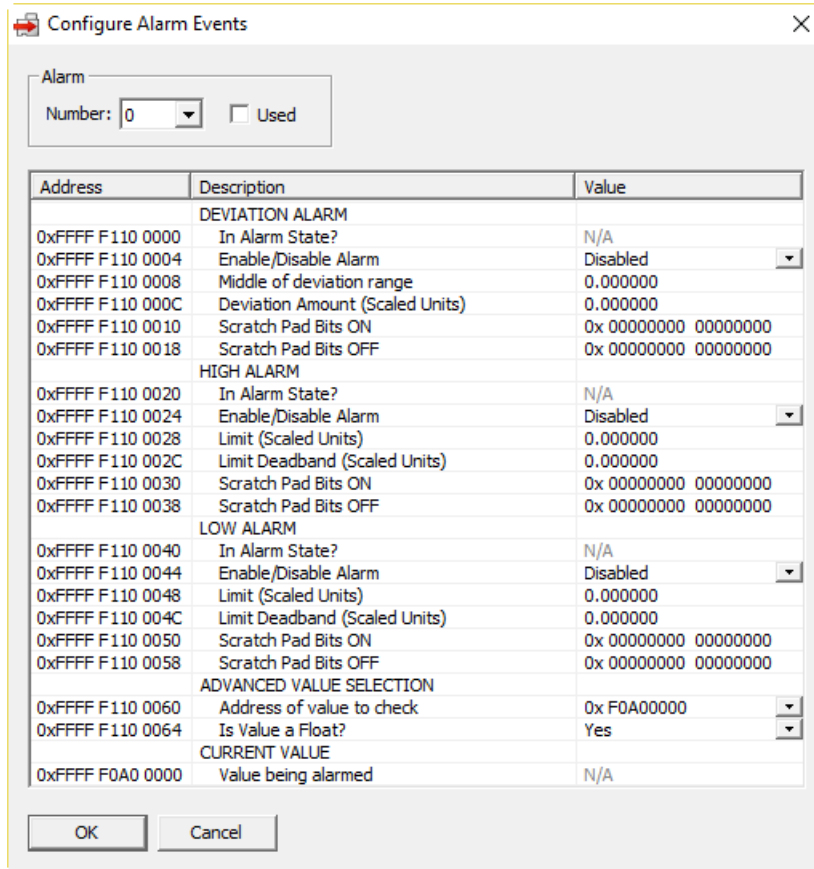

- In the drop-down list, choose the Alarm Number you want to use (by default, it is the same number as the point the alarm will monitor). Click Used.  
The alarm number can be any unused number, but it is best to use the point number, since by default that point's memory map address and value are shown in the Value Being Alarmed field.  
If you need to set two or more alarms on the same point, however, you can do so. For additional alarms, choose a different alarm number, configure the alarm, and enter the memory map address for the point in the Advanced Value Selection section. (A complete list of memory map addresses is in the [OptoMMP Protocol Guide](#), form 1465.)
- Find the section for the type of alarm you want to use (deviation, high, or low). In the Value column, click the Enable/Disable Alarm cell and choose Enabled from the drop-down list. Click in other cells to set deviation or alarm limits. For high and low alarms, also set the deadband for the limit.  
A deadband is an allowable variation in the limit to account for signal noise. If the signal fluctuates slightly, the deadband limit keeps the I/O unit from sending out another alarm.
- For each alarm, also configure the reaction in two parts:
  - Scratch Pad bits that should be turned on
  - Scratch Pad bits that should be turned off
 See ["The Scratch Pad"](#) on page 145.
- (Optional) If you are setting two or more alarms on the same point, use the Advanced Value Selection area to enter the memory map address for the point to monitor, and indicate whether the value on that point is a float.
- Repeat from [step 3](#) for additional alarms. When you have finished configuring alarms, click OK.



- Click the Save button  to save the configuration file.

## CONFIGURING SERIAL OR WIEGAND EVENTS AND REACTIONS

**PAC-R  
EB  
UIO  
EIO**

If you are using Opto 22 serial communication modules—RS-232, RS-485/422, or Wiegand—with SNAP PAC, SNAP Ultimate, or SNAP Ethernet I/O units, you can configure a serial or Wiegand event to send a serial message, to send an SNMP trap, or to turn bits in the Scratch Pad on or off when a specific string is received from one or more modules.

Before you configure serial events and reactions, make sure you have configured the serial modules ([page 60](#)).

- In the PAC Manager main window, with a configuration file open, right-click the name of the I/O unit on which you want to set up serial or Wiegand events and choose Configure from the pop-up menu.

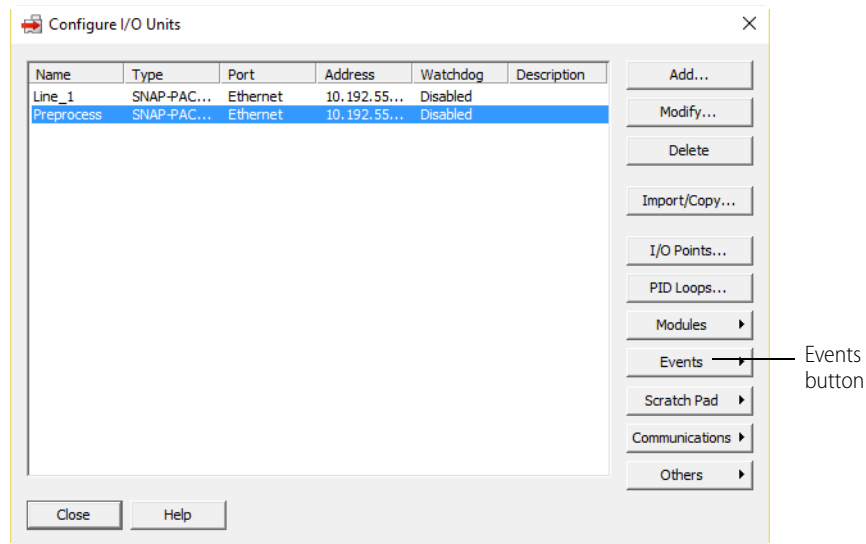

- Click the Events button and choose Serial Events from the pop-up menu, or if you are configuring events for a Wiegand serial communication module, choose Wiegand Events.

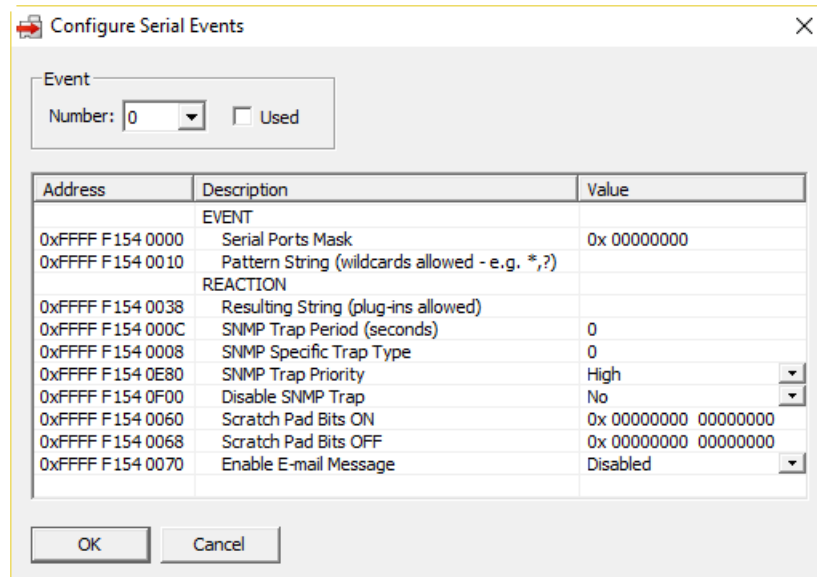

## CONFIGURING SERIAL OR WIEGAND EVENTS AND REACTIONS

The example above shows the Configure Serial Events dialog box; the Wiegand Events dialog box is similar.

3. In the drop-down list, choose the lowest unused Event Number. Click Used.

*NOTE: To reduce scanning time, the I/O unit stops scanning serial events when it reaches an unused event. Make sure you use event numbers in order, starting with the lowest.*

4. In the Event section, enter a mask in hex notation indicating the serial ports to monitor.

The I/O unit monitors all ports set as “on” bits in the mask (on = 1; off = 0). If the string is received from *any* of those serial ports, the event triggers the reaction. For example, suppose you have serial modules in positions 1 and 2 on the rack. (Other kinds of modules are in positions 0 and 3.) The following table shows how you might figure out the mask to monitor three of these serial ports:

Module position:	←	3		2		1		0	
Serial port:		–	–	B	A	B	A	–	–
Default TCP port number:		–	–	22505	22504	22503	22502	–	–
Monitor? (Y or N):		–	–	Y	N	Y	Y	–	–
Mask (binary notation):		0	0	1	0	1	1	0	0
Mask (hex notation):		2				C			

The complete hex mask you would enter to monitor these ports is: 0000002C.

5. Enter the pattern string the event should match.

The string is limited to 40 characters. Wildcards (\* and ?) can be used.

6. In the Reaction section, do any or all of the following:

- a. To send text in an SNMP trap or a one-time email message, complete the Resulting string field.

If you send a string, it is limited to 126 characters. You can place data from the serial module or the I/O unit’s memory map into the string by using any or all of the following plugins:

\$!_str_	Includes the pattern string in the resulting string.
\$!_port_	Shows which serial port sent the pattern string.
\$!X_YYYYYYYY_	Includes data from a memory map address. See <a href="#">“Using Plugins” on page 111</a> for more information.

For example, a resulting string that includes the pattern string, the serial port that sent it, and the text *Overload* would look like this:

```
$!_str_ $!_port_ Overload
```

- b. To send an SNMP trap, also enter how often in seconds to send the trap (use zero to send it only once), and enter the trap type. Remember to configure email ([page 116](#)).  
Trap types are determined by your SNMP management system.
  - c. To send a one-time email notification, also enable E-mail Message. Make sure to configure email ([page 116](#)).  
To send multiple emails, don’t enable email here. Instead, turn on a Scratch Pad bit ([step e](#)) and set up the email when you configure event messages ([page 108](#)).
  - d. To send a serial message out a serial port, don’t put the message here. Instead, turn on a Scratch Pad bit ([step e](#)) and set up the serial message when you configure event messages ([page 108](#)).
  - e. To set Scratch Pad bits, enter masks for the bits to turn on and the bits to turn off when the serial event occurs.
7. Repeat from [step 3](#) for other serial events and reactions. When you have finished configuring serial events and reactions, click OK.
  8. Click the Save button  to save the configuration file.

## CONFIGURING EVENT MESSAGES

PAC-R  
EB  
UIO  
EIO

If you are using PAC Control or PAC Manager 9.0 or higher, configure event messages in the configuration file as shown on [page 108](#).

If you are not using PAC Control or are using a PAC Manager version less than 9.0, you cannot configure event messages in a configuration file. Instead, use PAC Manager's Inspect mode and follow the steps below. Note that event messages are not available on SB brains, since messaging requires an Ethernet connection.

1. In the PAC Manager main window, click the Inspect button .
  - If you have not used the Inspect window before, the window will not show any data. Select your controller from the drop-down list.
  - If you *have* used the Inspect window before, the last device you inspected is shown in the Device Name field, and current Status Read information appears in the window.

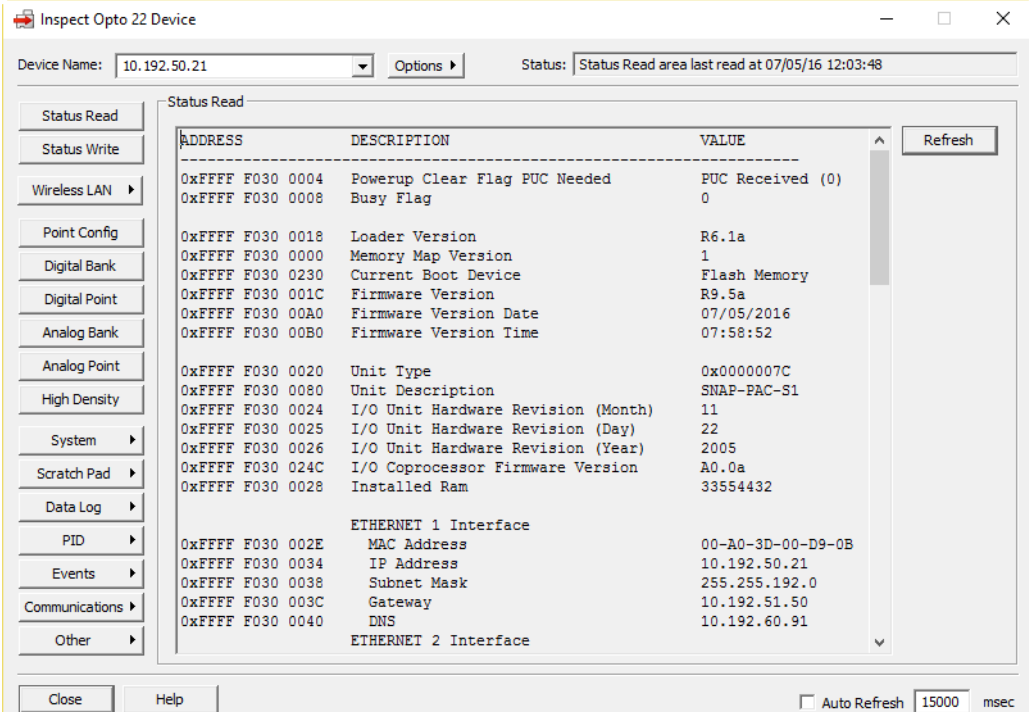

Inspect Opto 22 Device

Device Name: 10.192.50.21    Status: Status Read area last read at 07/05/16 12:03:48

ADDRESS	DESCRIPTION	VALUE
0xFFFF F030 0004	Powerup Clear Flag PUC Needed	PUC Received (0)
0xFFFF F030 0008	Busy Flag	0
0xFFFF F030 0018	Loader Version	R6.1a
0xFFFF F030 0000	Memory Map Version	1
0xFFFF F030 0230	Current Boot Device	Flash Memory
0xFFFF F030 001C	Firmware Version	R9.5a
0xFFFF F030 00A0	Firmware Version Date	07/05/2016
0xFFFF F030 00B0	Firmware Version Time	07:58:52
0xFFFF F030 0020	Unit Type	0x0000007C
0xFFFF F030 0080	Unit Description	SNAP-PAC-S1
0xFFFF F030 0024	I/O Unit Hardware Revision (Month)	11
0xFFFF F030 0025	I/O Unit Hardware Revision (Day)	22
0xFFFF F030 0026	I/O Unit Hardware Revision (Year)	2005
0xFFFF F030 024C	I/O Coprocessor Firmware Version	A0.0a
0xFFFF F030 0028	Installed Ram	33554432
ETHERNET 1 Interface		
0xFFFF F030 002E	MAC Address	00-A0-3D-00-D9-0B
0xFFFF F030 0034	IP Address	10.192.50.21
0xFFFF F030 0038	Subnet Mask	255.255.192.0
0xFFFF F030 003C	Gateway	10.192.51.50
0xFFFF F030 0040	DNS	10.192.60.91
ETHERNET 2 Interface		

Close    Help     Auto Refresh    15000 msec

- If you have configured other devices, they are listed in alphabetical order in the drop-down list.
- If you have configured six or more devices, the Inspect window provides two additional time-saving features: Next and Back navigation buttons (to navigate back and forth through the alphabetized list

## CONFIGURING EVENT MESSAGES

of devices), and a list of the five most recently inspected devices (displayed at the top of the drop-down list).

Next and Back navigation buttons and Most Recently Used list are displayed when you have six or more devices configured.

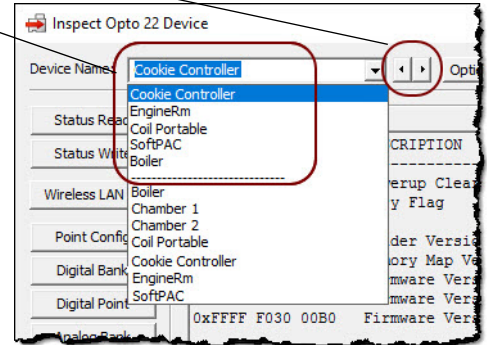

2. In the Device Name field, type the name (or IP address) of the I/O unit (or choose it from the drop-down list).
3. Click Events and choose Event Messages from the submenu.

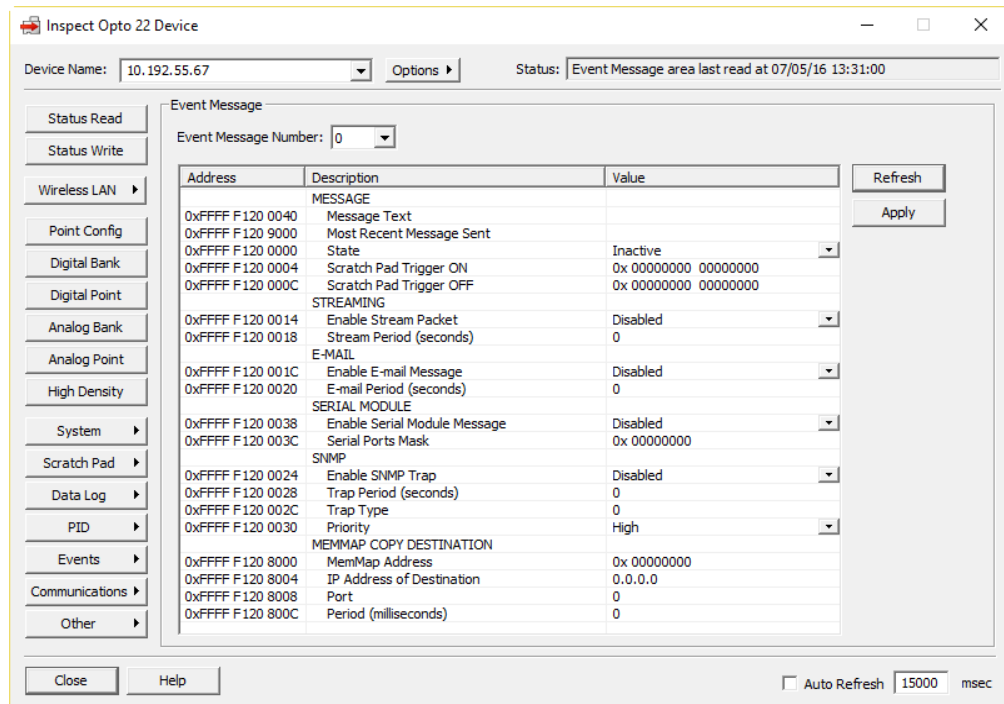

4. From the drop-down list, choose the lowest unused message number. Unused message numbers have no asterisk.
5. For an email or serial message, or optionally for an SNMP message, enter the message text. Message text is not sent in the streaming packet. Message text is limited to 127 characters. You can place data from the I/O unit's memory map into the message by using a plugin (see page 111). If you are sending a serial message, make sure the text is formatted so the serial device that receives it will understand it.

6. Enter two masks indicating the Scratch Pad on and off bits that should trigger the message.  
For help in figuring out the masks, see [“Digital Point and Scratch Pad Masks” on page 151](#).
7. Streaming section: To send a stream of data as the message, choose Enabled from the drop-down list. Enter how often in seconds to send the stream (0 sends it only once).  
For information on streaming, see [page 112](#).
8. E-mail section: To send an email message, choose Enabled from the drop-down list. Enter how often in seconds to send the email (0 sends it only once).
9. Serial Module section: To send a message through a serial module to a serial device, choose Enabled from the drop-down list. Enter a mask representing the modules and ports to receive the message.  
Information in [“Configuring Serial or Wiegand Events and Reactions” on page 159](#) may be helpful.
10. SNMP section: To send an SNMP trap as the message, change Disabled to Enabled. Enter how often to send the trap (0 sends it only once). Also enter the trap type (determined by your SNMP management software). If you are using SNMP with outgoing PPP and want the trap stored in the I/O unit until the next communication, set Priority to Low. If you want the I/O unit to immediately dial out and send the trap, set Priority to High.  
For information on SNMP, see [page 112](#).

*NOTE: SNMP messages must be acknowledged. You can do so in your application or in PAC Manager's Inspect window: in the Message section, change the State to Acknowledge and click Apply.*

11. Memmap Copy Destination section: To copy memory map data, complete this section using information from [“Copying Memory Map Data” on page 125](#).
12. When all fields are correct, click Apply.
13. Repeat from [step 4](#) to configure additional event messages.
14. For each type of message you configure, make sure you also set up basic configuration:

Serial:	See <a href="#">page 60</a>
SNMP:	See <a href="#">page 112</a>
Email:	See <a href="#">page 116</a>
Streaming:	See <a href="#">page 120</a>

15. When you have finished configuring all event messages and any additional configuration required for them, in the PAC Manager Inspect window, make sure the IP address shown is the correct one. Then click the Status Write button in the upper-left part of the window.

16. In the Operation Commands list, highlight Store configuration to flash.

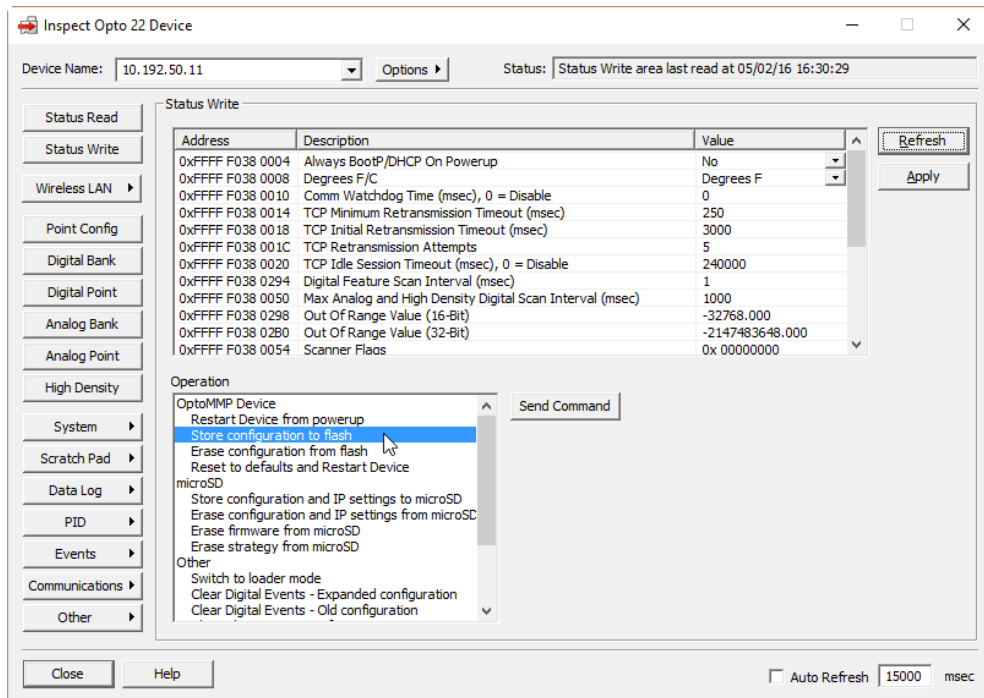

17. Click Send Command.

The configuration data is stored to flash memory and a Success message appears.

*IMPORTANT: For the following configurations, you must also restart the unit for configuration to take effect:*

*Changes in TCP port for serial modules                      SNMP configuration*  
*Email configuration    PPP configuration*  
*Data logging interval*

18. If you have configured any of these items, in the Operation Commands list, highlight Restart I/O Unit from powerup. Click Send Command.

The I/O unit is restarted and a success message appears.

# 5: Reading and Writing to Specific Devices

## INTRODUCTION

This chapter shows you how to read and write to a SNAP PAC controller, an Ethernet-based controller, or I/O unit directly by using PAC Manager's Inspect window. In addition to reading and writing specific values, you can configure points and functions using the steps in this chapter. However, **these configurations cannot be saved to a configuration file.**

Because all reads and writes using the steps in this chapter are sent directly to the controller or I/O unit, the device you are reading from or writing to must be on the same network as your PC or laptop computer. For a SNAP PAC SB brain, you can read or write to the brain through a SNAP PAC S-series controller, or you can connect the computer directly to the brain using a PCI-AC48 adapter card and a serial cable. For more information on these connections, see the [SNAP PAC Brains User's Guide](#) (form 1690).

**CAUTION**—*If you are using PAC Control: When you read and write to specific devices using the instructions in this chapter, the reads and writes occur independently of PAC Control strategy logic. If you are using PAC Control, you normally use the flowchart logic in the PAC Control strategy to read and write to the I/O unit. It's not a problem to read directly, but if you use the instructions in this chapter to write to an I/O unit, be very careful that your actions do not conflict with PAC Control logic.*

As you use PAC Manager's Inspect window, you'll notice that the starting memory map address for each item is shown. This can be a handy way to determine addresses you need for programming or configuration. You can also highlight an address and right-click it to copy it; then you can paste it where you are using it.

You can also copy and paste part or all of the data you read in the Inspect window. Just highlight the data you want to copy and use standard Microsoft® Windows® commands such as Ctrl+C to copy the data, and Ctrl+V to paste it into a text, email, or other file.

## READING BASIC DEVICE INFORMATION

PAC-S  
PAC-R  
SoftP  
EB  
SB  
UIO  
EIO  
SIO  
E1  
E2

1. If PAC Manager isn't already open, start it. (For instructions, see the footnote on [page 16](#).)
2. In the PAC Manager main window, click the Inspect button  (or in the PAC Manager menu bar, click Tools > Inspect).  
The Inspect window opens.
  - If you haven't used the Inspect window before, no data is displayed in the Status Read pane.
  - If you *have* used the Inspect window before, the last device you inspected is shown in the Device Name field, and current Status Read information appears in the window.

## READING BASIC DEVICE INFORMATION

- If you have configured other devices, they are listed in alphabetical order in the drop-down list.

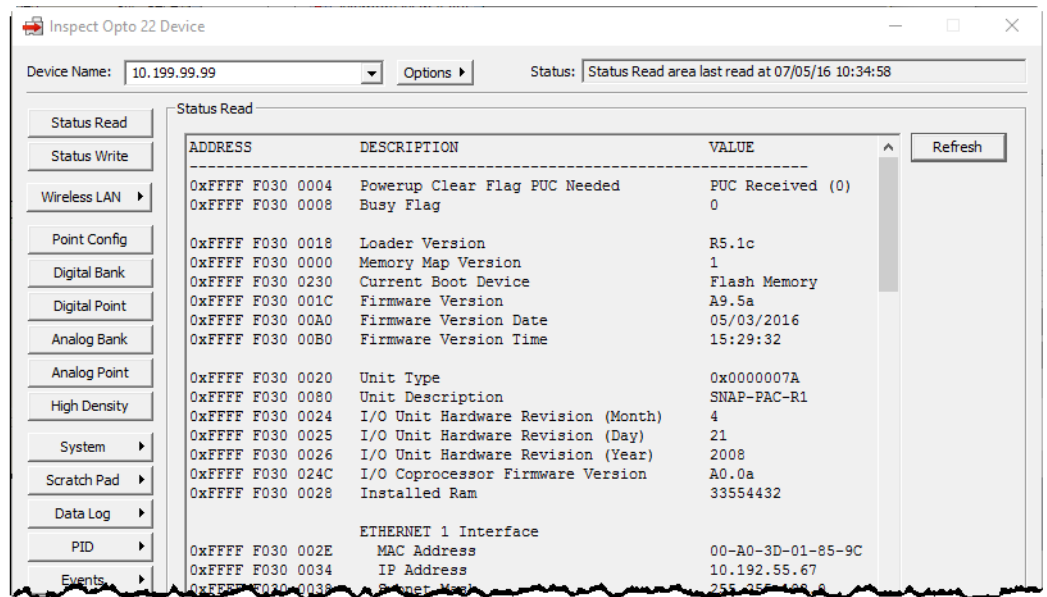

- If you have configured six or more devices, the Inspect window provides two additional time-saving features: Next and Back navigation buttons (to navigate back and forth through the alphabetized list of devices), and a list of the five most recently inspected devices (displayed at the top of the drop-down list).

Next and Back navigation buttons and Most Recently Used list are displayed when you have six or more devices configured.

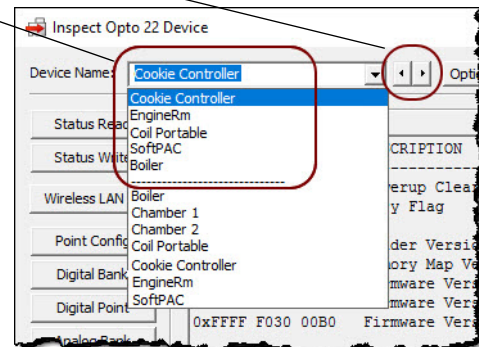

3. In the Device Name field, type the name (or IP address) of the controller or I/O unit (or choose it from the drop-down list). Click Status Read.



Information from the device is displayed in the window.

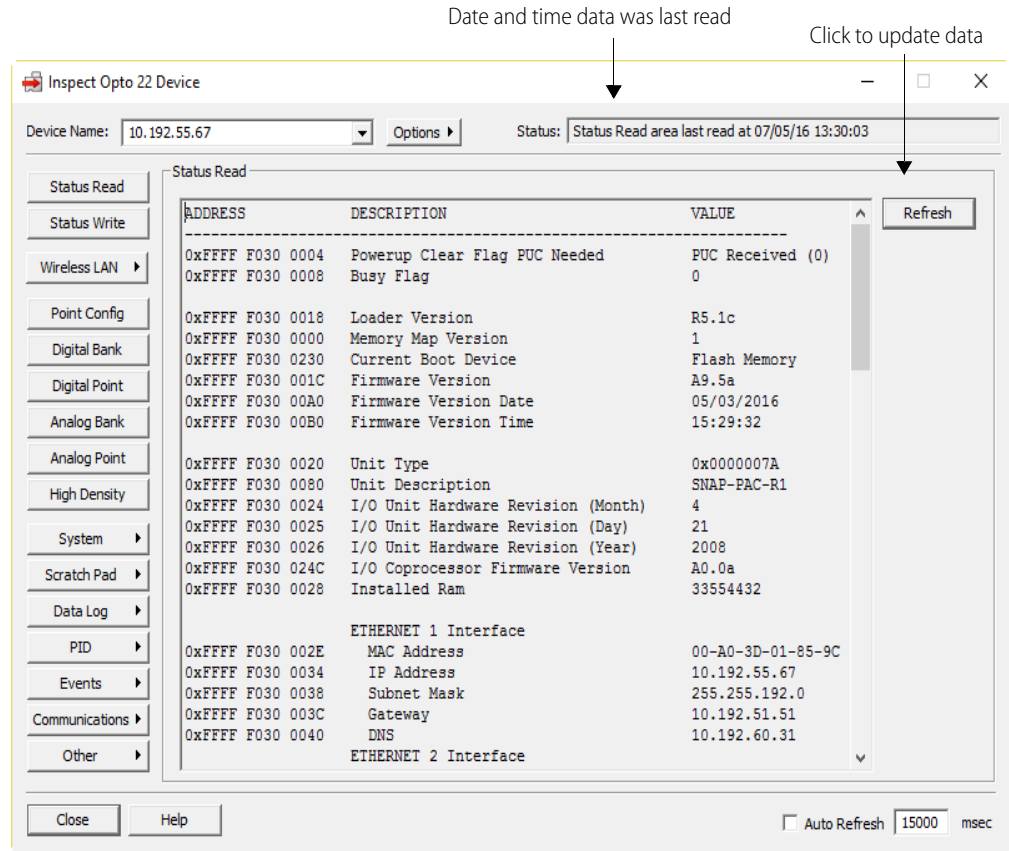

Scroll down to see all of the information. Data is current as of the date and time shown in the Status field at the top right corner of the window. (Note that date and time are from the computer, not from the I/O unit.) To update data, click the Refresh button. See the next two pages for help in interpreting data.

PAC-S  
PAC-R  
SoftP  
EB  
SB  
UIO  
EIO  
SIO  
E1  
E2

### Interpreting Status Data

The following table may help you interpret the information you see in the Status Read window. Some items may not appear, depending on the Opto 22 device you are using. Some of this information can be changed (see page 170). Much of it is used only for troubleshooting. If you have additional questions about status data, contact Product Support (see page 4).

The term "device" is used in this table to refer to a SNAP PAC brain or controller, or a SNAP Ethernet-based I/O unit, E1 or E2 brain board.

Description	Explanation
Powerup Clear Flag PUC needed	Since a powerup clear (PUC) is automatically sent by the device whenever it is turned on, this value should show PUC Received.
Busy Flag	Zero means the device is not busy and can process your requests.
Loader Version	Revision number of the device's loader. The loader is like a basic input/output system (BIOS).
Memory Map Version	Revision number of the device's memory map

Description	Explanation
Current Boot Device	(PAC-R and PAC-S only) Whether the PAC booted from its Flash memory or from a microSD card
Firmware Version	
Firmware Version Date	Revision number of the device's firmware, and the date and time of the revision
Firmware Version Time	
Unit Type	Hex code indicating the device type.
Unit Description	Part number of the device (brain, brain board, or controller)
I/O Unit Hardware Revision (Month)	
I/O Unit Hardware Revision (Day)	Version date of the device's hardware
I/O Unit Hardware Revision (Year)	
I/O Coprocessor Firmware Version	(Applicable to rack-mounted controllers and brains manufactured starting in 2016.) Revision number of the I/O coprocessor firmware. If the value is 0 (zero) or A0.0a, your device does not have an I/O coprocessor. For more information, see the <a href="#">SNAP PAC I/O Coprocessor Firmware Readme</a> .
Installed Ram	Number of bytes of RAM in the device
Product Serial Number	(SB brains only) Barcoded product number inside the brain
Address	(SB brains only) Current serial address of the brain
Baud Rate	(SB brains only) Current baud rate of the brain
Number of Framing Errors	(SB brains only) A serial transmission error; normally zero. If it's not zero, verify baud rate or check for noise on the serial bus.
Number of FIFO Overrun Errors	(SB brains only) Normally zero. Any value other than zero indicates that serial characters are being dropped.
Communications Debug Flag	(SB brains only) A value of 1 indicates that Communication Error Blink Codes are enabled. See the brain user's guide for details.
MAC Address	Unique hardware Media Access Control (MAC) identifier for the device, assigned at the Opto 22 factory. MAC addresses for all Opto 22 devices start with 00-A0-3D.
IP Address	
Subnet Mask	IP address, subnet mask, and default gateway for the device on the Ethernet network. You assign these numbers; see <a href="#">page 15</a> .
Gateway	
DNS or Name Server	Not currently used; leave at 0.0.0.0
Ethernet 2 MAC Address	(SNAP PAC controllers only) Unique hardware Media Access Control (MAC) identifier for the second Ethernet interface on the device.
Ethernet 2 IP Address	(SNAP PAC controllers only) IP address, subnet mask, and default gateway for the second
Ethernet 2 Subnet Mask	Ethernet interface on the device. You assign these numbers; see <a href="#">page 30</a> .
Ethernet 2 Gateway	
Ethernet 2 DNS	(SNAP PAC controllers only) Not currently used; leave at 0.0.0.0
Wireless LAN MAC Address	(Wired+Wireless devices only) Unique hardware Media Access Control (MAC) identifier for the device's wireless LAN interface.
WLAN IP Address	
WLAN Subnet Mask	(Wired+Wireless devices only) IP address, subnet mask, and gateways for the wireless LAN interface on the device. You assign these numbers; see <a href="#">page 35</a> .
WLAN Primary Gateway	
WLAN Secondary Gateway	
WLAN Primary DNS	
WLAN Secondary DNS	(Wired+Wireless devices only) Not currently used; leave at 0.0.0.0

Description	Explanation
Host Name	(E1 and E2 only) The device's current host name. See "E1 and E2 brain boards" on <a href="#">page 176</a> for more information on host names.
Domain Name	(E1 and E2 only) If you are using host names, the domain name for the device. See "E1 and E2 brain boards" on <a href="#">page 176</a> .
Always BootP/DHCP On Powerup	A value of 0 (the normal setting) means the device sends a request (a BootP or DHCP request) for an IP address only if its IP address is 0.0.0.0. A value of 1 means the device sends a BootP or DHCP request every time it is turned on. See <a href="#">page 15</a> for more information.
Degrees F/C <sup>1</sup>	Whether temperatures on the I/O unit are handled in Fahrenheit or Celsius. Set when you configure the I/O unit ( <a href="#">page 44</a> ). Celsius is the default.
Comm Watchdog Time (msec) <sup>1</sup>	If the I/O unit has a watchdog, the watchdog timeout in milliseconds. Set when you configure the I/O unit ( <a href="#">page 44</a> ). Default is 0 (no watchdog).
Out of Range Value (16-bit)	Only for SNAP PAC analog input modules that return 16-bit values. If a value goes out of range, this number appears as the value. Default is -32,768. Can be changed; see <a href="#">page 170</a> .
Out of Range Value (32-bit)	Only for SNAP PAC analog input modules that return 32-bit values, such as the SNAP-AIRATE-HFi and SNAP-AIRTD-8U modules. If a value goes out of range, this number appears as the value. Default is -2147483648. Can be changed; see <a href="#">page 170</a> .
Scanner Flags	Shows scanner and control engine options. Value can be any of the following or a combination of them, in hex. See "Scanner Flags" on <a href="#">page 173</a> for more information. 1 = Alarms are being processed in the digital scanner rather than the analog scanner. <sup>1,2</sup> 2 = Analog/HDD scanner is disabled. (Disables scanning of high-density digital modules as well as analog modules.) <sup>1,2</sup> 4 = Digital scanner is disabled. <sup>1,2</sup> 8 = (applies to all standalone and on-the-rack controllers) PAC Control engine is stopped.
4-Channel Digital Scan Count <sup>1,2</sup>	Shows the number of times the processor (brain or on-the-rack controller) has scanned the digital points for 4-channel digital modules on the I/O unit. Can be used for benchmarking.
Analog & High Density Dig Scan Count <sup>1,2</sup>	Shows the number of times the processor has scanned the analog and high-density digital module points on the I/O unit. Can be used for benchmarking.
Milliseconds Since Powerup <sup>2</sup>	Milliseconds since the last time the device was turned on. Value rolls over after 4,294,967,295 ms, which is equal to 49.71 days.
Elapsed Time Since Powerup	Time since the device was last turned on. Time is shown in the format <code>days:hh:mm:ss</code>
TCP Minimum RTO (msec.) <sup>2</sup>	TCP communication settings; see <a href="#">page 251</a> .
TCP Initial RTO (msec.) <sup>2</sup>	
TCP Retransmits <sup>2</sup>	
TCP Idle Session Timeout (msec.) <sup>2</sup>	
TCP Idle Session Timeout Count <sup>2</sup>	Number of times the device closed the session because it was idle.
Ethernet Errors: Late Collisions <sup>2</sup>	Values other than 0 may indicate network problems. See <a href="#">page 253</a> .
Ethernet Errors: Excessive Collisions <sup>2</sup>	
Ethernet Errors: Others <sup>2</sup>	
Smart Modules Present <sup>1,2</sup>	Mask in hex showing location of analog, serial, and high-density digital, and PID modules on the rack. Module 15 is in bit position 15; module 0 is in bit position 0. (For help in understanding masks, see "Mask Data" on <a href="#">page 218</a> .)
PID Loops Supported <sup>2</sup>	(PAC-R, PAC EB & SB brains, UIO, and EIO only) Maximum number of PID loops possible on the device (96 on PAC-R, EB, and SB brains; 32 on UIO; 16 on EIO). See <a href="#">page 78</a> .

Description	Explanation
Digital Modules Supported	Number of 4-channel digital modules supported (0, 8, or 16). Added in PAC firmware 8.1; older firmware doesn't include this address. Useful for SNAP-PAC-R1 and SNAP-PAC-R1-B. Due to B-series rack limitations, R1-Bs support 4-channel I/O modules only in the first 8 rack positions. R1s with serial numbers below 600,000 support 8 digital modules in the first 8 rack positions; newer R1s support 16.
Arcnet Reconfigs Detected <sup>1,2</sup>	Indicates that a smart module has been added, removed, or reset. (ARCNET is used on the rack for communication between the processor and analog, serial, or high-density digital, or PID modules.) <i>NOTE: If the rack contains only 4-channel digital modules, ignore this value.</i>
Arcnet Reconfigs Initiated by I/O Unit <sup>1,2</sup>	Error on the rack's ARCNET bus. Not a concern unless it happens frequently.
Arcnet Transmit Attempts Since Powerup <sup>1,2</sup>	
Arcnet ACKs <sup>1,2</sup>	
Arcnet Timeouts <sup>1,2</sup>	
Arcnet Other (node not found, etc.) <sup>1,2</sup>	Refers to the ARCNET bus on the rack. May be useful in troubleshooting communication to analog, serial, or high-density digital, and PID modules.
Arcnet Timeout Value (msec.) <sup>1,2</sup>	
Arcnet Receive Interrupts <sup>1,2</sup>	
Ethernet MAC Resets Since Powerup <sup>2</sup>	Caused by EMI, RFI, or other electrical noise.
Dig. Output Point Resets Since Powerup <sup>1,2</sup>	
Dig. Interrupt Failures Since Powerup <sup>1,2</sup>	Related to digital counters. May have missed counts. Contact Opto 22 Product Support.
Analog & High Density Digital Scanner <sup>1,2</sup>	(milliseconds per scan) Average length of time the processor takes to scan all analog and high-density digital points on the rack. Based on the last 100 scans (last 50 scans for points on high-density digital modules, as they are included in every second scan). A value of -1 means the scanner is not running.
4-Channel Digital Scanner <sup>1,2</sup>	(milliseconds per scan) Average length of time the processor takes to scan all 4-channel digital points on the rack, based on the last 100 scans. A value of -1 means the scanner is not running.
Module X - Times Discovered <sup>1,2</sup>	How many times the processor has rediscovered a smart module (analog, serial, high-density digital). Normal value is zero; values over 1 may indicate that a module is resetting.

<sup>1</sup> Does not apply to SNAP PAC S-series and SoftPAC controllers

<sup>2</sup> Does not apply to E1 and E2 brain boards

PAC-S  
PAC-R  
SoftP  
EB  
SB  
UIO  
EIO  
SIO  
E1  
E2

### Changing Status Data

The following items in the Status Read/Status Write windows can be changed in PAC Manager if the device supports them.

- |   |                                 |
|---|---------------------------------|
| Always BootP/DHCP on Powerup                      | Out of Range Value (16-bit)     |
| Degrees F/C                                       | Out of Range Value (32-bit)     |
| Comm Watchdog Time                                | Scanner Flags                   |
| TCP Settings                                      | Host Name                       |
| Digital Feature Scan Interval                     | Domain Name                     |
| Max Analog and High Density Digital Scan Interval | Strategy Download Method        |
|   | Turnaround Delay                |
|   | Communication Error Blink Codes |
|   | Ethernet 2 Interface Settings   |

- In the PAC Manager main window, click the Inspect button . The Inspect window opens.
  - If you haven't used the Inspect window before, no data is displayed in the Status Read pane.
  - If you *have* used the Inspect window before, the last device you inspected is shown in the Device Name field, and current Status Read information appears in the window.
  - If you have configured other devices, they are listed in alphabetical order in the drop-down list.

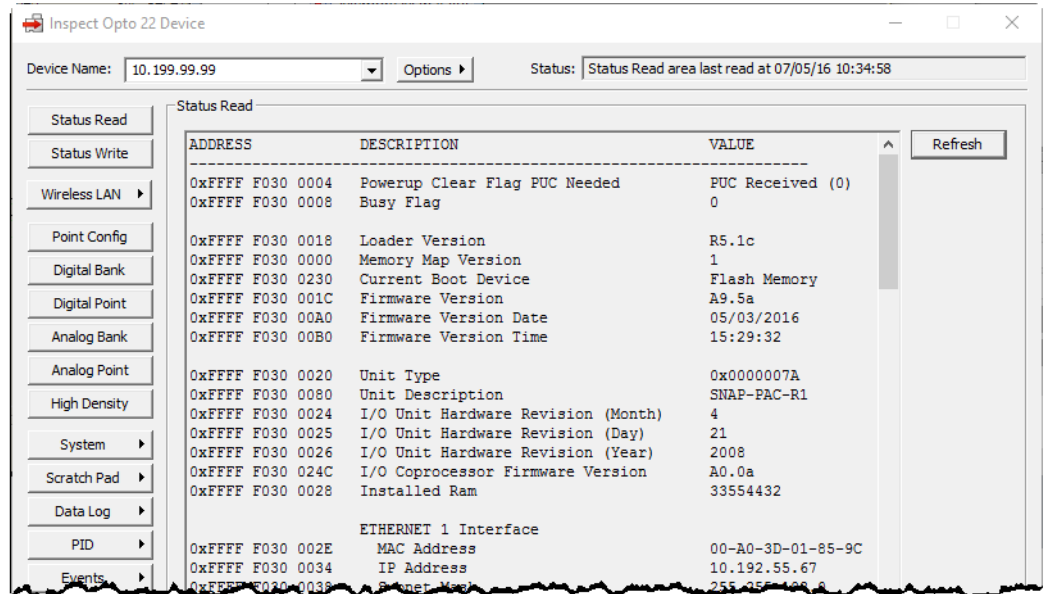

- If you have configured six or more devices, the Inspect window provides two additional time-saving features: Next and Back navigation buttons (to navigate back and forth through the alphabetized list of devices), and a list of the five most recently inspected devices (displayed at the top of the drop-down list).

Next and Back navigation buttons and Most Recently Used list are displayed when you have six or more devices configured.

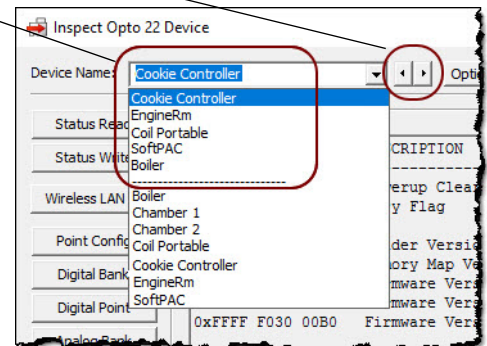

- In the Device Name field, type the name of the device (or choose it from the drop-down list).

3. Click Status Write.

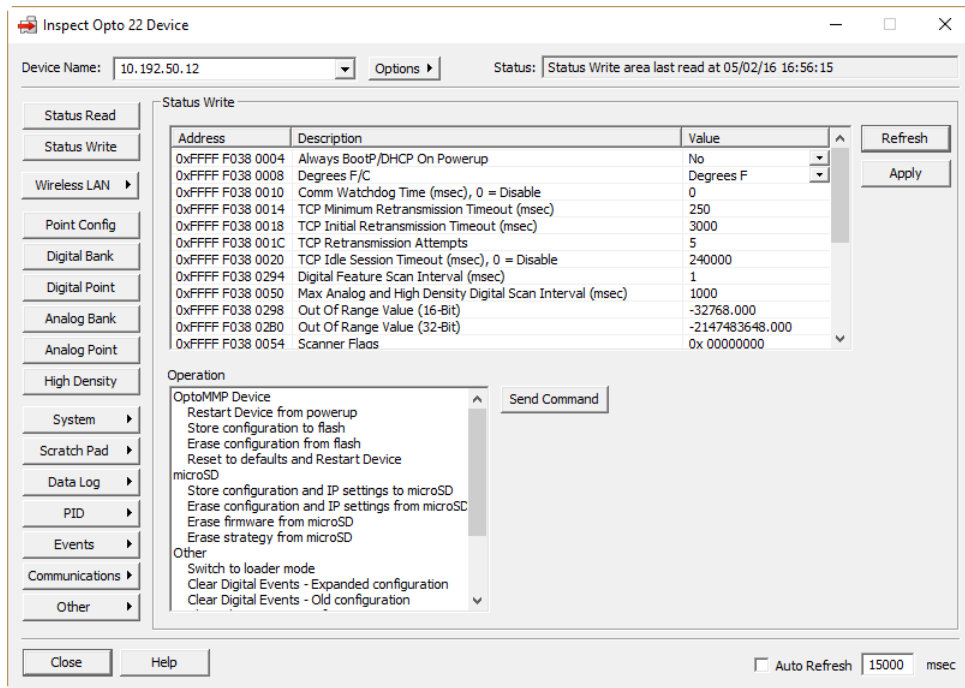

Items that can be changed are listed in the upper section of the dialog box. To change one, click its Value field and either choose from the drop-down list or enter the new value as described below:

**Always BootP/DHCP on Powerup** (All devices): If you change this field to Yes, the current IP address becomes temporary and the device will send a BootP or DHCP broadcast the next time it is turned on. If you change this field to No, the current IP address is saved to flash memory and becomes a static IP address.

**Degrees F/C** and **Comm Watchdog Time** (I/O units only): Changes settings for the whole I/O unit. *IMPORTANT:* Set Degrees F/C before configuring temperature inputs. If some inputs are already configured, reset their Upper and Lower Scaled Units after changing Degrees F/C.

**TCP settings** (All devices except E1 and E2): *CAUTION:* Before changing TCP settings, see [page 251](#).

**Digital Feature Scan Interval** (PAC-R, EB, SB) or **Max 4-Channel Digital Scan Interval** (UIO, EIO, SIO) and **Max Analog and High Density Digital Scan Interval** (I/O units only): Default is 1000 milliseconds for analog and 1 milliseconds for digital. You can decrease the scan interval (to make it scan more frequently) to make sure the scanner isn't slowed or stopped by heavy communication on the network. (This is not a problem for E1s and E2s because they scan differently.) You can also shut down the scanner immediately by changing its scan interval value to -1 (does not require restarting the I/O unit). As of PAC firmware version 8.1, analog modules with more than 4 points are scanned no faster than every 30 milliseconds, and analog modules with four or fewer points are scanned no faster than every 6 milliseconds, to maintain synchronization with the module. Note that scan interval changes revert to default values when power is lost, unless you save your changes to flash.

**Out of Range Value (16-Bit)** and **Out of Range Value (32-Bit)**: Set the value that an analog input module returns when a signal is above or below a defined range. If the default out-of-range value is potentially a valid in-range value, you can enter a different value to indicate an out-of-range condition. Most SNAP analog input modules use the 16-bit out-of-range value, which has a default value of -32,768. Analog input modules that return a 32-bit value (such as the SNAP-AIRATE-HFi and SNAP-AIRTD-8U modules) use the 32-bit out-of-range value, whose default value is -2147483648.

**Scanner Flags:** To change the way scanners work or stop/start the control engine, enter one or a combination of the following values in hex.

- (PAC-R, EB, SB, UIO, EIO, and SIO only) (I/O units only) To process alarms in the digital scanner rather than the analog scanner, enter 1.
- (PAC-R, EB, SB, UIO, EIO, and SIO only) (I/O units only) To disable the analog scanner, enter 2.
- (PAC-R, EB, SB, UIO, EIO, and SIO only) (I/O units only) To disable the digital scanner, enter 4.
- (PAC-R, and UIO only) To stop the PAC Control engine runtime, enter 8.

For example, if you have a SNAP-PAC-R1 I/O unit with digital I/O only and are not using a PAC Control strategy, you can get faster reactions to events by entering 1 + 2 + 8, which would be 0x0000000B. *NOTE: You must save to flash and restart for this change to take effect.*

**Host name** (E1s and E2s only): The I/O unit's host name can be changed here. The host name can include letters, numbers, and minus signs (hyphens). The first character must be a letter and the last letter must be a letter or a number. Host names are not case sensitive and can be from two to 63 characters long. See "E1 and E2 brain boards" on page 15 "About IP Addresses" for more information on host names.

**Strategy Download Method** (SNAP PAC controllers only): Choose Background to enable background downloading. (For details, see the [PAC Control User's Guide](#), form 1700).

**Turnaround Delay** (controllers or brains with serial ports): Enter how long the controller or brain should wait to send a response to serial communication. Default is zero (no delay).

**Communication Error Blink Codes** (SB brains only): For troubleshooting, choose Enabled from the drop-down list to see communication error blink codes. (See the Troubleshooting section in the brain user's guide for details.) Be sure you turn off blink codes after troubleshooting; they will degrade performance.

**Ethernet 2 IP Address** information (SNAP PAC controllers only): See "Assigning an IP Address to Ethernet 2 (SNAP PAC Controller Only)" on page 30 for information.

4. When you have finished entering changes, click Apply.

Most changes take effect immediately. If you change the Scanner Flags, secondary IP address information, or strategy download method, however, you must **store the configuration to flash and then restart** the controller or brain. See also "Assigning an IP Address to Ethernet 2 (SNAP PAC Controller Only)" on page 30.

## Referencing I/O Points

PAC-R  
EB  
UIO  
EIO  
SIO  
E1  
E2

The following sections show input and output point numbers for I/O units.

For **SNAP serial communication modules**, see page 176. You will also need the [SNAP Serial Communication Module User's Guide](#) (form 1191).

**CAUTION:** Make certain you are using the correct rack for the processor. Using an incompatible rack can cause severe damage to the brain or controller.

To reference I/O points, see the section for the rack you are using:

SNAP PAC rack (SNAP-PAC-RCK4, SNAP-PAC-RCK8, etc.)	SNAP-PAC-R1 SNAP-PAC-R2	see <a href="#">page 174</a>
SNAP M-series rack (SNAP-M16, SNAP-M64, etc.)	SNAP-UP1-M64 SNAP-ENET-S64	
SNAP B-series rack (SNAP-B4M, SNAP-B8MC, SNAP-B12MC-P, SNAP-B16M, etc.)	SNAP-PAC-R1-B SNAP-UP1-ADS SNAP-B3000-ENET SNAP-ENET-RTC	see <a href="#">page 175</a>

SNAP-D64RS rack	SNAP-UP1-D64 SNAP-ENET-D64	see <a href="#">page 175</a>
Racks for G4, G1, or Quad Pak digital modules	E1	see <a href="#">page 176</a>
Racks for G1 analog modules	E2	see <a href="#">page 176</a>

PAC-R  
EB  
SB  
UIO  
EIO  
SIO

**SNAP PAC Racks**

Use any of these racks	With any of these processors
SNAP-PAC-RCK4 (or SNAP-M16) SNAP-PAC-RCK4-FM SNAP-PAC-RCK8 (or SNAP-M32) SNAP-PAC-RCK8-FM SNAP-PAC-RCK12 (or SNAP-M48) SNAP-PAC-RCK12-FM SNAP-PAC-RCK16 (or SNAP-M64) SNAP-PAC-RCK16-FM	SNAP-PAC-R1, SNAP-PAC-R1-FM, SNAP-PAC-R1-W SNAP-PAC-R2, SNAP-PAC-R2-FM, SNAP-PAC-R2-W SNAP-PAC-EB1, SNAP-PAC-EB1-FM, SNAP-PAC-EB1-W SNAP-PAC-EB2, SNAP-PAC-EB2-FM, SNAP-PAC-EB2-W SNAP-PAC-SB1 SNAP-PAC-SB2 SNAP-ENET-S64 SNAP-UP1-M64

SNAP PAC mounting racks can hold up to 4, 8, 12, or 16 Opto 22 SNAP I/O modules. Point features and modules supported vary by processor; see the processor’s data sheet for specifications.

Each module contains 1 to 32 channels (points), depending on the module. Examples of modules are shown in the following diagram.

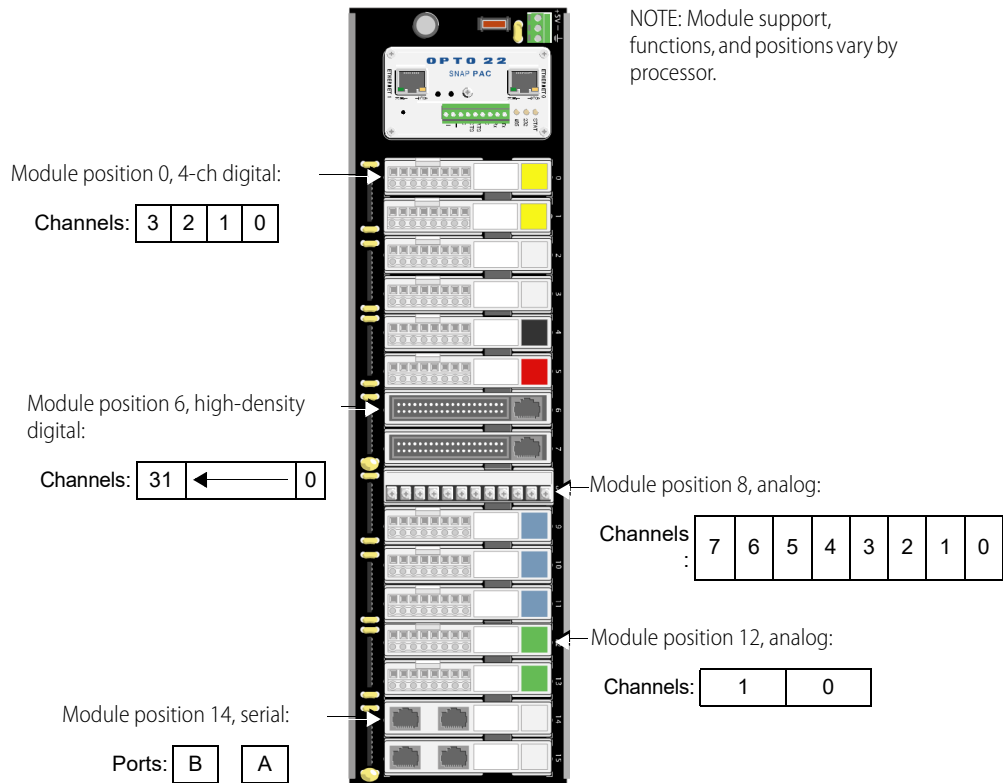



### SNAP B-Series Racks

Use any of these racks			With any of these processors
SNAP-B4	SNAP-B8MC	SNAP-B8MC-P	SNAP-PAC-R1-B
SNAP-B8	SNAP-B12MC	SNAP-B12MC-P	SNAP-UP1-ADS
SNAP-B12	SNAP-B16MC	SNAP-B16MC-P	SNAP-B3000-ENET
SNAP-B16			SNAP-ENET-RTC

*NOTE: SNAP B-series racks and the processors compatible with them are not recommended for new development. Use SNAP PAC racks and processors instead.*

SNAP B-series mounting racks can hold up to 4, 8, 12, or 16 Opto 22 SNAP I/O modules. (Not all modules are supported by these processors; for details, see [Legacy and Current SNAP Product Comparison and Compatibility Charts](#), form 1693.) Analog, serial, and high-density digital modules (digital modules with more than four points) can be placed in any position. For the larger racks, 4-channel digital modules can be placed in positions 0–7 only. Each module contains 1 to 32 points (channels), depending on the module. Examples of modules are shown in the following diagram.

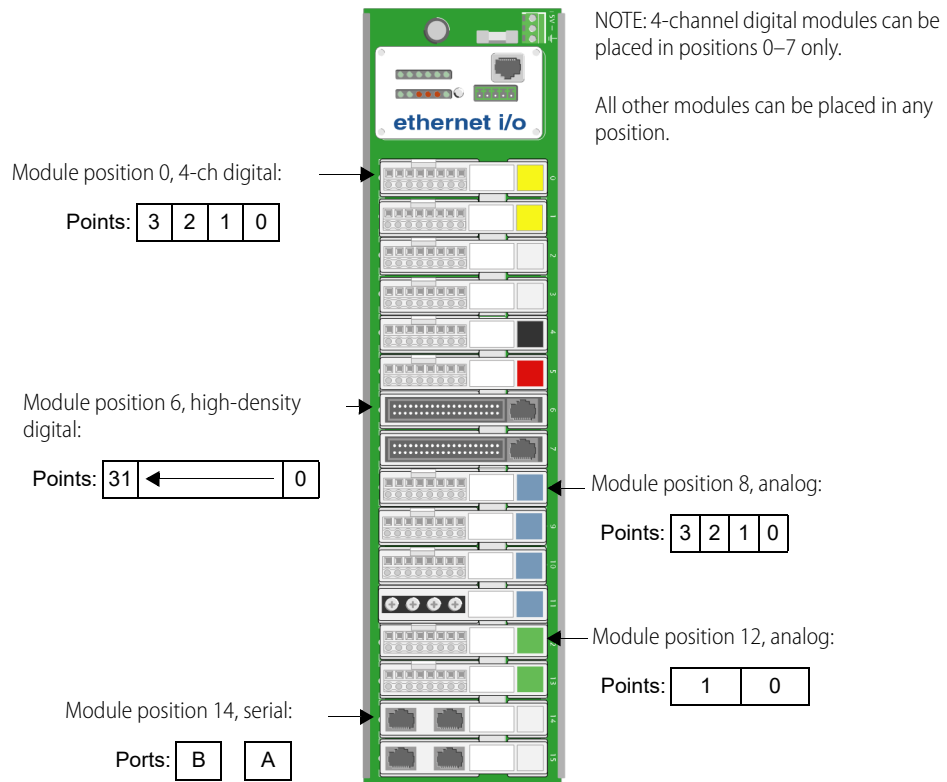

### SNAP Digital-Only Racks

*NOTE: Digital-only racks and processors are not recommended for new development. Use SNAP PAC racks and processors instead.*

The SNAP-D64RS mounting rack is compatible with SNAP-UP1-D64 and SNAP-ENET-D64 processors. The rack holds up to 16 4-channel SNAP digital I/O modules. Analog, serial, and high-density digital modules are not supported. Module position 0 is the position closest to the processor.

### Serial Modules

The following table applies to these I/O units only:

SNAP-PAC-R1	SNAP-ENET-S64
SNAP-PAC-R2	SNAP-UP1-ADS
SNAP-PAC-EB1	SNAP-UP1-M64
SNAP-PAC-EB2	SNAP-ENET-RTC
SNAP-B3000-ENET	

*NOTE: Serial modules cannot be used with SNAP PAC SB brains.*

SNAP-SCM-232, SNAP-SCM-485, SNAP-SCM-485-422, and SNAP-SCM-W2 modules each have two serial ports, A and B. Profibus modules (SNAP-SCM-PROFI) have one serial port.

To establish an Ethernet connection between the SNAP PAC I/O unit and a serial module, you use the IP address of the I/O unit the module is on, plus the TCP port number for the module's serial port. The following table shows default port numbers for each port in each position on the largest rack. For a Profibus module, use the Port A port number.

Module Position	Port	TCP port Number	Module Position	Port	TCP port Number
0	A	22500	8	A	22516
	B	22501		B	22517
1	A	22502	9	A	22518
	B	22503		B	22519
2	A	22504	10	A	22520
	B	22505		B	22521
3	A	22506	11	A	22522
	B	22507		B	22523
4	A	22508	12	A	22524
	B	22509		B	22525
5	A	22510	13	A	22526
	B	22511		B	22527
6	A	22512	14	A	22528
	B	22513		B	22529
7	A	22514	15	A	22530
	B	22515		B	22531

These port numbers can be changed if necessary. See [page 60](#) for instructions.

**E1  
E2**

### E1 and E2 Brain Boards

*NOTE: You can configure E1 and E2 brain boards like any other I/O unit if you have E1/E2 firmware R1.2a (and higher) and PAC Project 9.5000 (and higher). Also, if a SNAP PAC controller communicates with the E1 or E2, the controller must have PAC firmware R9.5a (or higher) to use this simplified configuration method.*

*If you are not using these firmware and software versions, then when you use the memory map with E1s and E2s, each module on the E1 or E2 corresponds to the first point on a similar SNAP module.*

**E1 brain boards** can be used with a variety of modules. The maximum number of points is 16 on the largest rack, as shown below.

**E1 shown with G4 modules.**

Since each module has just one point, use only the first point for each module in the memory map.

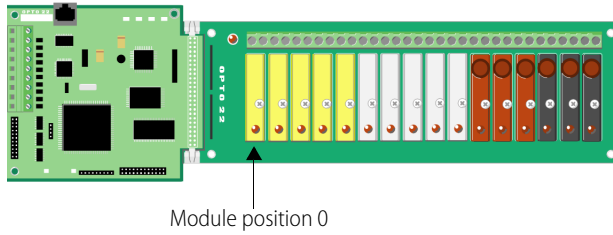

Module #	Point #
00	0
↓	↓
15	0

**E1 with Quad Pak modules.**

Quad Pak modules have four input or four output points, but each point is treated as if it were a separate one-point module.

Module position on Quad Pak rack	Module number	Point number
0	00	0
	01	0
	02	0
	03	0
1	04	0
	05	0
	06	0
	07	0
2	08	0
	09	0
	10	0
	11	0
3	12	0
	13	0
	14	0
	15	0

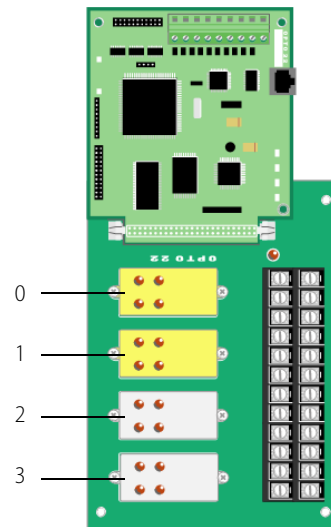

**E2 brain boards** are used with analog G1 modules only. The largest rack (shown below) holds 16 single-point modules.

**E2 with G1 modules.**

Since each module has just one point, use only the first point for each module in the memory map.



Module position 0

Module #	Point #
00	0
↓	↓
15	0

CONFIGURING I/O MODULES, POINTS, AND FEATURES

PAC-R  
EB  
SB  
UIO  
EIO  
SIO

Before you can read or write to I/O points, you must configure point types and point features. You can do so using PAC Manager’s Inspect window. Remember, however, that configurations you set in the Inspect window cannot be saved to a configuration file. They are sent directly to an individual I/O unit. To use a configuration file, see “Chapter 2: Configuring Devices,” especially “Configuring I/O Modules and Points” on page 48.

*NOTE: You can configure E1 and E2 brain boards like any other I/O unit if you have E1/E2 firmware R1.2a (and higher) and PAC Project R9.5000 (and higher). Also, if a SNAP PAC controller communicates with the E1 or E2, the controller must have PAC firmware R9.5a (or higher) to use this simplified configuration method.*

*If you are not using these firmware and software versions and you are communicating with your E1 or E2 I/O units using Optomux only, you do not need to configure them in PAC Manager. However, if you are also communicating with E2 I/O units using OptoMMP, Modbus/TCP, or PAC Project software (including OptoOPCServer), you must configure them. For details, see I/O Configuration for E1 and E2 (form 1576).*

**Point Types Requiring Configuration**

The SNAP PAC I/O processor can recognize analog, serial, and high-density digital modules, and it assumes a default configuration for all points on those modules. Any module position not occupied by an analog, serial, or high-density module is assumed to be a 4-channel digital input module.

You’ll need to configure the following point types:

- All digital output points on 4-channel digital modules. Use point type 180.
- Analog points that do not use the default point type for the module. For example, if the points on a SNAP-AIRTD module are 120 Ohm Nickel 3-wire RTDs (–80 to +260 °C), they must be configured, because the default for that module is 100 Ohm Platinum 3-wire RTDs (–200 to +850 °C). Point types for analog modules are shown in the tables beginning on page 182. Default point types are indicated.

For point types, configuration requirements vary based on the type of processor.

**SNAP PACs, SNAP Ultimate, SNAP Ethernet, and SNAP Simple I/O processors with analog capability.** The processor can recognize analog, serial, and high-density digital modules, and it assumes a default configuration for all points on those modules. Any module position not occupied by an analog, serial, or high-density module is assumed to be a 4-channel digital input module.

For these processors, you must configure the following point types:

- All digital output points on 4-channel digital modules. Use point type 180.
- Analog points that do not use the default point type for the module. For example, if the points on a SNAP-AIRTD module are 120 Ohm Nickel 3-wire RTDs (–80 to +260 °C), they must be configured, because the default for that module is 100 Ohm Platinum 3-wire RTDs (–200 to +850 °C). Point types for analog modules are shown in the tables beginning on [page 182](#). Default point types are indicated.

*NOTE: You can configure E1 and E2 brain boards like any other I/O unit if you have E1/E2 firmware R1.2a (and higher) and PAC Project R9.5000 (and higher). Also, if a SNAP PAC controller communicates with the E1 or E2, the controller must have PAC firmware R9.5a (or higher) to use this simplified configuration method.*

*If you are not using these firmware and software versions, then these rules apply:*

*Digital-only SNAP Ethernet-based brains and E1 brain boards: The brain or brain board assumes that all points are digital input points. You must configure all digital output points with point type 180.*

*E2 brain boards: You must configure point types for all points on the rack. Point types are shown in the tables beginning on [page 182](#).*

*For more information, see [I/O Configuration for E1 and E2](#) (form 1576).*

## Point Features Requiring Configuration

Point features vary based on the processor and the module. The following point features are not automatic and must be configured for each point that uses them:

- High-speed digital input counters and quadrature counters
- Digital and analog watchdogs
- Analog scaling, clamping, offset and gain, and average filter weight

See [“Using I/O Point Features” on page 85](#) for a description of features.

PAC-R  
EB  
SB  
UIO  
EIO  
SIO  
E1  
E2

## Configuring Analog and Digital Points and Features

*NOTE: You can configure E2 brain boards like any other I/O unit if you have E1/E2 firmware R1.2a (and higher) and PAC Project R9.5000 (and higher). Also, if a SNAP PAC controller communicates with the E2, the controller must have PAC firmware R9.5a (or higher) to use this simplified configuration method.*

*If you are not using these firmware and software versions (or if you prefer to use the previous method to reconfigure existing E2s), see [I/O Configuration for E1 and E2](#) (form 1576).*

1. In the PAC Manager main window, click the Inspect button  .

The Inspect window opens.

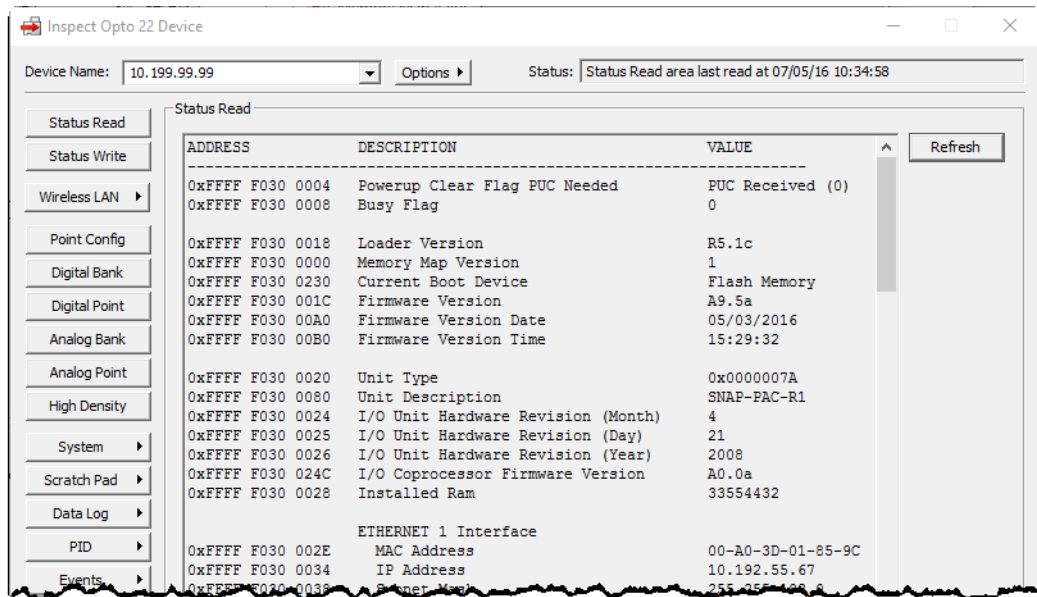

- In the Device Name field, type the name (or IP address) of the I/O unit (or choose it from the drop-down list). Click Point Config.

Module position number

Point numbers for this module are shown in yellow.

Point zero is currently being read here. Since this is not an analog point, analog values are grayed out.

To update values, click the Refresh button. To modify values, change the parameters (if applicable) and click Apply.

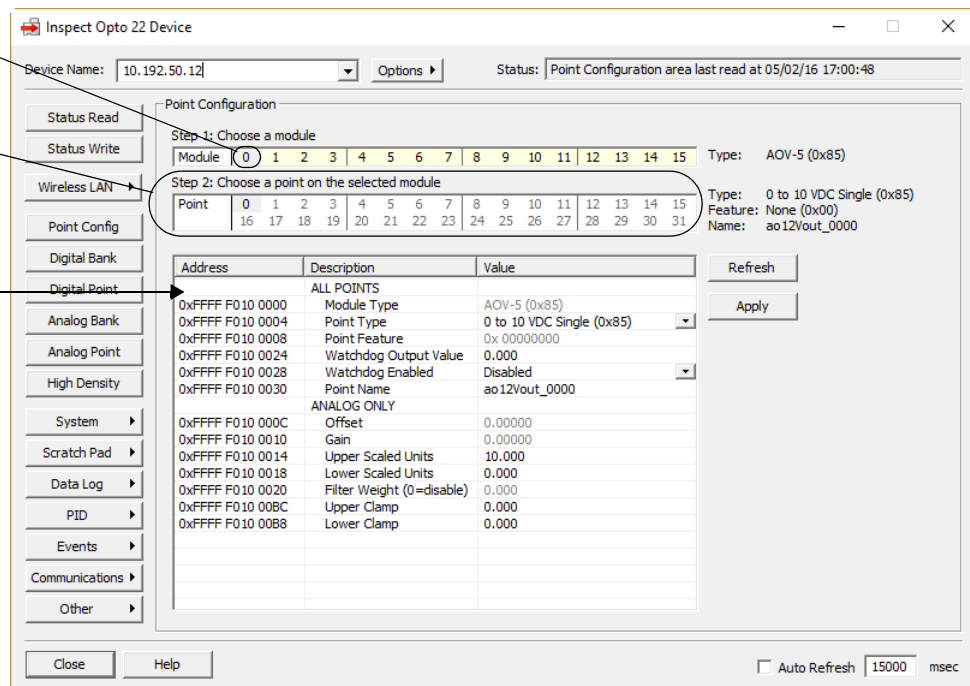

Module position numbers are shown near the top of the page; point numbers for multi-point modules are shown below. For more information on locating modules and points, see [“Referencing I/O Points” on page 173](#).

3. Click the module position and the point number you want to view or configure.
4. Choose or enter the following as necessary for the point.
  - a. Choose the point type from the drop-down list.  
For help, see [“Point Type Configuration Tables” on page 181](#) and [“Using I/O Point Features” on page 85](#).
  - b. Configure digital input counters in the Point Feature field as shown below:
 

0x00000000	Disables all digital point features
0x00000001	Enables and starts counter on digital input
0x00000004	Simple quadrature counter input (requires SNAP quadrature input module)
0x00000041	Quadrature counter input with index (requires SNAP quadrature input module)
  - c. For automatic reaction to analog or digital watchdogs, enable the watchdog and enter the value that the output point should be set to if the watchdog is tripped.
  - d. (Analog points only) To set offset and gain for the point manually, enter values in those fields. (To have the processor compute offset and gain, see [“Calibrating Offset and Gain Using the Default Method” on page 196](#).)
  - e. (Analog points only) Set upper and lower scaled units, filter weight, and upper and lower clamps as necessary. (For help, see [“Using I/O Point Features” on page 85](#).)
5. When all lines are correct, click Apply to send the configuration to the I/O unit.  
All other points on the same module are automatically configured with the same features and the same point name.
6. Click another point on the same module and change its point name and features as necessary.
7. Repeat steps for each module you need to configure.  
To save configuration to flash memory, see [“Saving Configuration to a Device’s Flash Memory” on page 212](#).

PAC-R  
EB  
SB  
UIO  
EIO  
SIO

### Point Type Configuration Tables

The following tables help you configure points by showing the part number, the point type in decimal and in hex, and the module type in hex (module type is read-only). For analog modules, tables also include the number of points per module, the unit of measurement for the module, and its range.

Digital Input and Output Modules	page 182
Analog Input Modules	page 182
Analog Output Modules	page 188

Digital Input and Output Modules

Module & Description	Point Type (Dec)	Point Type (Hex)	Module Type (Hex)
Digital input module*	256	100	00
Digital output module*	384	180	00

\* Does not apply to SNAP high-density digital modules, which are recognized by the processor.

Analog Input Modules

Use this data for configuring point types and features (see page 178). If a module has multiple listings, the default point type is shaded.

Part Number & Description	Channel Type (Dec)	Channel Type (Hex)	Module Type (Hex)	Channels per Module	Default Unit of Measurement	Underrange	Low Scale	Full Scale	Overrange
<b>SNAP-AIARMS</b> : 0–10 AAC/DC	71	47	71	2	A	0.0	0.0	10.0	11.0
<b>SNAP-AIARMS-i</b> : 0–10 AAC/DC	71	47	29	2	A	0.0	0.0	10.0	11.0
<b>SNAP-AIARMS-i-FM</b> : 0–10 AAC/DC	71	47	29	2	A	0.0	0.0	10.0	11.0
<b>SNAP-AICTD</b> : ICTD Temp. Probe	4	4	04	2	Degrees C	-273.0	-40.0	150.0	150.0
<b>SNAP-AICTD-4</b> : ICTD Temp. Probe	4	4	42	4	Degrees C	-273.0	-40.0	150.0	150.0
<b>SNAP-AICTD-8</b> : ICTD Temp. Probe	4	4	4C	8	Degrees C	-273.0	-40.0	150.0	150.0
<b>SNAP-AILC</b> : -2 to +2 mV/V Fast	34	22	0B	2	Percent	-110.0	-100.0	100.0	110.0
SNAP-AILC: -2 to +2 mV/V Slow	36	24	0B	2	Percent	-110.0	-100.0	100.0	110.0
SNAP-AILC: -3 to +3 mV/V Fast	35	23	0B	2	Percent	-110.0	-100.0	100.0	110.0
SNAP-AILC: -3 to +3 mV/V Slow	37	25	0B	2	Percent	-110.0	-100.0	100.0	110.0
SNAP-AILC: Filter of 1st channel	0	0	0B	2	Percent	-110.0	-100.0	100.0	110.0
<b>SNAP-AILC-2</b> : -3 to +3 mV/V Fast	35	23	0C	2	Percent	-110.0	-100.0	100.0	110.0
SNAP-AILC-2: -3 to +3 mV/V Slow	37	25	0C	2	Percent	-110.0	-100.0	100.0	110.0
<b>SNAP-AILC-2</b> : -4 to +4 mV/V Fast	34	22	0C	2	Percent	-110.0	-100.0	100.0	110.0
SNAP-AILC-2: -4 to +4 mV/V Slow	36	24	0C	2	Percent	-110.0	-100.0	100.0	110.0
SNAP-AILC-2: Filter of 1st channel	0	0	0C	2	Percent	-110.0	-100.0	100.0	110.0
<b>SNAP-AIMA</b> : -20 to +20 mA	64	40	64	2	mA	-22.0	-20.0	20.0	22.0
SNAP-AIMA: 0 to +20 mA	2	2	64	2	mA	-22.0	0.0	20.0	22.0
SNAP-AIMA: 4 to +20 mA	3	3	64	2	mA	-22.0	4.0	20.0	22.0
<b>SNAP-AIMA2-i</b> : -1 to +1 mA	85	55	27	2	mA	-1.1	-1.0	1.0	1.1
<b>SNAP-AIMA-i</b> : -20 to +20 mA	64	40	22	2	mA	-22.0	-20.0	20.0	22.0
SNAP-AIMA-i: 0 to +20 mA	2	2	22	2	mA	-22.0	0.0	20.0	22.0
SNAP-AIMA-i: 4 to +20 mA	3	3	22	2	mA	-22.0	4.0	20.0	22.0
<b>SNAP-AIMA-iH</b> : 4 to +20 mA	3	3	2A	2	mA	3.2	4.0	20.0	24.0
<b>SNAP-AIMA-iSRC</b> : -20 to +20 mA	64	40	26	2	mA	-22.0	-20.0	20.0	22.0
SNAP-AIMA-iSRC: 0 to +20 mA	2	2	26	2	mA	-22.0	0.0	20.0	22.0
SNAP-AIMA-iSRC: 4 to +20 mA	3	3	26	2	mA	-22.0	4.0	20.0	22.0
<b>SNAP-AIMA-iSRC-FM</b> : -20 to +20 mA	64	40	26	2	mA	-22.0	-20.0	20.0	22.0



Part Number & Description	Channel Type (Dec)	Channel Type (Hex)	Module Type (Hex)	Channels per Module	Default Unit of Measurement	Underrange	Low Scale	Full Scale	Overrange
SNAP-AIMA-iSRC-FM: 0 to +20 mA	2	2	26	2	mA	-22.0	0.0	20.0	22.0
SNAP-AIMA-iSRC-FM: 4 to +20 mA	3	3	26	2	mA	-22.0	4.0	20.0	22.0
<b>SNAP-AIMA-4</b> : -20 to +20 mA	64	40	40	4	mA	-22.0	-20.0	20.0	22.0
SNAP-AIMA-4: 0 to +20 mA	2	2	40	4	mA	-22.0	0.0	20.0	22.0
SNAP-AIMA-4: 4 to +20 mA	3	3	40	4	mA	-22.0	4.0	20.0	22.0
<b>SNAP-AIMA-8</b> : -20 to +20 mA	64	40	4A	8	mA	-22.0	-20.0	20.0	22.0
SNAP-AIMA-8: 0 to +20 mA	2	2	4A	8	mA	-22.0	0.0	20.0	22.0
SNAP-AIMA-8: 4 to +20 mA	3	3	4A	8	mA	-22.0	4.0	20.0	22.0
<b>SNAP-AIMA-32</b> : -20 to +20 mA	64	40	4D	32	mA	-22.0	-20.0	20.0	22.0
SNAP-AIMA-32: 0 to +20 mA	2	2	4D	32	mA	-22.0	0.0	20.0	22.0
SNAP-AIMA-32: 4 to +20 mA	3	3	4D	32	mA	-22.0	4.0	20.0	22.0
<b>SNAP-AIMA-32-FM</b> : -20 to +20 mA	64	40	4D	32	mA	-22.0	-20.0	20.0	22.0
SNAP-AIMA-32-FM: 0 to +20 mA	2	2	4D	32	mA	-22.0	0.0	20.0	22.0
SNAP-AIMA-32-FM: 4 to +20 mA	3	3	4D	32	mA	-22.0	4.0	20.0	22.0
<b>SNAP-AIMV-4</b> : -150 to +150 mV	66	42	44	4	mV	-165.0	-150.0	150.0	165.0
SNAP-AIMV-4: -75 to +75 mV	68	44	44	4	mV	-82.5	-75.0	75.0	82.5
<b>SNAP-AIMV2-4</b> : -50 to +50 mV	9	9	45	4	mV	-55.0	-50.0	50.0	55.0
SNAP-AIMV2-4: -25 to +25 mV	67	43	45	4	mV	-27.5	-25.0	25.0	27.5
<b>SNAP-AIPM</b> (channel 0 only)	70	46	0A	*	AC VRMS	0.0	0	250	275
<b>SNAP-AIPM</b> (channel 1 only)	71	47	0A	*	AC ARMS	0.0	0	10	11.0
<b>SNAP-AIPM</b> (channel 2 only)	82	52	0A	*	True power	n/a	n/a	n/a	n/a
<b>SNAP-AIPM</b> (channel 3 only)	83	53	0A	*	Volt/Amps	n/a	n/a	n/a	n/a
<b>SNAP-AIPM-3</b> (channels 0, 4 & 8)	70	46	49	*	AC VRMS	0.0	0	300	330
<b>SNAP-AIPM-3</b> (channels 1, 5 & 9)	71	47	49	*	AC ARMS	0.0	0	5	5.5
<b>SNAP-AIPM-3</b> (channels 2, 6 & 10)	82	52	49	*	True power	n/a	n/a	n/a	n/a
<b>SNAP-AIPM-3</b> (channels 3, 7 & 11)	83	53	49	*	Volt/Amps	n/a	n/a	n/a	n/a
<b>SNAP-AIPM-3</b> (channels 12 & 13)	86	56	49	*	True power	n/a	n/a	n/a	n/a
<b>SNAP-AIPM-3V</b> (channels 0, 4 & 8)	100	64	48	*	AC VRMS	0.0	0	300	330
<b>SNAP-AIPM-3V</b> (channels 1, 5 & 9)	89	59	48	*	VAC from CT	0.0	0	0.333	0.366
<b>SNAP-AIPM-3V</b> (channels 2, 6 & 10)	90	5A	48	*	True power	n/a	n/a	n/a	n/a
<b>SNAP-AIPM-3V</b> (channels 3, 7 & 11)	90	5A	48	*	Volt/Amps	n/a	n/a	n/a	n/a
<b>SNAP-AIPM-3V</b> (channels 12 & 13)	184	B8	48	*	True power	n/a	n/a	n/a	n/a
<b>SNAP-AIRATE</b> : Rate (Frequency)	69	45	69	2	Hz	0.0	0.0	25000.0	27500.0
<b>SNAP-AIRATE-HFi</b> : Rate (0.1 s data freshness)	68	44	2B	2	Hz	2	2	500,000	500,000
<b>SNAP-AIRATE-HFi</b> : Rate (1 s data freshness)	69	45	2B	2	Hz	20	20	500,000	500,000

Part Number & Description	Channel Type (Dec)	Channel Type (Hex)	Module Type (Hex)	Channels per Module	Default Unit of Measurement	Underrange	Low Scale	Full Scale	Overrange
<b>SNAP-AIRTD</b> : 100 Ohm Pt 3-wire	10	0A	10	2	Degrees C	-200.0	-200.0	850.0	850.0
SNAP-AIRTD: 100 Ohm Ni 3-wire	46	2E	10	2	Degrees C	-60.0	-60.0	250.0	250.0
SNAP-AIRTD: 0–400 Ohms, Lead Compensated	15	0F	10	2	Ohms	0	0	400	440
SNAP-AIRTD: 120 Ohm Ni 3-wire	48	30	10	2	Degrees C	-80.0	-80.0	260.0	260.0
<b>SNAP-AIRTD-10</b> : 10 Ohm Cu 3-wire	14	0E	0E	2	Degrees C	-180.0	-180.0	260.0	260.0
SNAP-AIRTD-10: 0–25 Ohms, Lead Compensated	15	0F	0E	2	Ohms	0	0	25	27.5
<b>SNAP-AIRTD-1K</b> : 1000 Ohm Pt 3-wire	92	5C	0F	2	Degrees C	-200.0	-200.0	850.0	850.0
SNAP-AIRTD-1K: 1000 Ohm Ni 3-wire	93	5D	0F	2	Degrees C	-60.0	-60.0	250.0	250.0
SNAP-AIRTD-1K: 1000 Ohm Ni 3-wire	94	5E	0F	2	Degrees F	-50.0	-50.0	275.0	275.0
SNAP-AIRTD-1K: 0–4000 Ohms, Lead Compensated	15	0F	0F	2	Ohms	0	0	4000	4400
<b>SNAP-AIRTD-8U</b> : 0–8000 Ohms - Fixed	155	9B	55	8	Ohms	0	0	8000	8800
SNAP-AIRTD-8U: 1000 Ohm Ni 3-wire @ 70° F	182	B6	55	8	Degrees F	-46	-46	148.9	148.9
SNAP-AIRTD-8U: 1000 Ohm Ni 3-wire @ 0 °C	181	B5	55	8	Degrees C	-40	-40	135	135
SNAP-AIRTD-8U: 1000 Ohm Pt @ 0 °C	180	B4	55	8	Degrees C	-200	-200	850	850
SNAP-AIRTD-8U: 120 Ohm Ni @ 0 °C	179	B3	55	8	Degrees C	-80	-80	260	260
SNAP-AIRTD-8U: 100 Ohm Ni @ 0 °C	178	B2	55	8	Degrees C	-60	-60	250	250
SNAP-AIRTD-8U: 100 Ohm Pt @ 0 °C	177	B1	55	8	Degrees C	-200	-200	850	850
SNAP-AIRTD-8U: 10 Ohm Cu	176	B0	55	8	Degrees C	-60	-60	355	355
SNAP-AIRTD-8U: 0–8000 Ohms - Auto	171	AB	55	8	Ohms	0	0	8000	8800
SNAP-AIRTD-8U: 0–4000 Ohms - Auto	170	AA	55	8	Ohms	0	0	4000	4400
SNAP-AIRTD-8U: 0–2000 Ohms - Auto	169	A9	55	8	Ohms	0	0	2000	2200
SNAP-AIRTD-8U: 0–1000 Ohms - Auto	168	A8	55	8	Ohms	0	0	1000	1100
SNAP-AIRTD-8U: 0–800 Ohms - Auto	167	A7	55	8	Ohms	0	0	800	880
SNAP-AIRTD-8U: 0–400 Ohms - Auto	166	A6	55	8	Ohms	0	0	400	440
SNAP-AIRTD-8U: 0–200 Ohms - Auto	165	A5	55	8	Ohms	0	0	200	220
SNAP-AIRTD-8U: 0–100 Ohms - Auto	164	A4	55	8	Ohms	0	0	100	110
SNAP-AIRTD-8U: 0–80 Ohms - Auto	163	A3	55	8	Ohms	0	0	80	88
SNAP-AIRTD-8U: 0–40 Ohms - Auto	162	A2	55	8	Ohms	0	0	40	44
SNAP-AIRTD-8U: 0–20 Ohms - Auto	161	A1	55	8	Ohms	0	0	20	22
SNAP-AIRTD-8U: 0–10 Ohms - Auto	160	A0	55	8	Ohms	0	0	10	11
SNAP-AIRTD-8U: 0–4000 Ohms - Fixed	154	9A	55	8	Ohms	0	0	4000	4400
SNAP-AIRTD-8U: 0–2000 Ohms - Fixed	153	99	55	8	Ohms	0	0	2000	2200
SNAP-AIRTD-8U: 0–1000 Ohms - Fixed	152	98	55	8	Ohms	0	0	1000	1100

Part Number & Description	Channel Type (Dec)	Channel Type (Hex)	Module Type (Hex)	Channels per Module	Default Unit of Measurement	Underrange	Low Scale	Full Scale	Overrange
SNAP-AIRTD-8U: 0–800 Ohms - Fixed	151	97	55	8	Ohms	0	0	800	880
SNAP-AIRTD-8U: 0–400 Ohms - Fixed	150	96	55	8	Ohms	0	0	400	440
SNAP-AIRTD-8U: 0–200 Ohms - Fixed	149	95	55	8	Ohms	0	0	200	220
SNAP-AIRTD-8U: 0–100 Ohms - Fixed	148	94	55	8	Ohms	0	0	100	110
SNAP-AIRTD-8U: 0–80 Ohms - Fixed	147	93	55	8	Ohms	0	0	80	88
SNAP-AIRTD-8U: 0–40 Ohms - Fixed	146	92	55	8	Ohms	0	0	40	44
SNAP-AIRTD-8U: 0–20 Ohms - Fixed	145	91	55	8	Ohms	0	0	20	22
SNAP-AIRTD-8U: 0–10 Ohms - Fixed	144	90	55	8	Ohms	0	0	10	11
<b>SNAP-AITM: -150 to +150 mV</b>	66	42	66	2	mV	-165.0	-150.0	150.0	165.0
SNAP-AITM: -75 to +75 mV	68	44	66	2	mV	-82.5	-75.0	75.0	82.5
SNAP-AITM: Type E Thermocouple	19	13	66	2	Degrees C	-270.0	-270.0	1000.0	1000.0
SNAP-AITM: Type J Thermocouple	5	5	66	2	Degrees C	-210.0	-210.0	1200.0	1200.0
SNAP-AITM: Type K Thermocouple	8	8	66	2	Degrees C	-270.0	-270.0	1372.0	1372.0
<b>SNAP-AITM-i: -150 to +150 mV</b>	66	42	20	2	mV	-165.0	-150.0	150.0	165.0
SNAP-AITM-i: -75 to +75 mV	68	44	20	2	mV	-82.5	-75.0	75.0	82.5
SNAP-AITM-i: Type E Thermocouple	19	13	20	2	Degrees C	-270.0	-270.0	1000.0	1000.0
SNAP-AITM-i: Type J Thermocouple	5	5	20	2	Degrees C	-210.0	-210.0	1200.0	1200.0
SNAP-AITM-i: Type K Thermocouple	8	8	20	2	Degrees C	-270.0	-270.0	1372.0	1372.0
<b>SNAP-AITM-4i: -150 to +150 mV</b>	66	42	32	4	mV	-165.0	-150.0	150.0	165.0
SNAP-AITM-4i: -75 to +75 mV	68	44	32	4	mV	-82.5	-75.0	75	82.5
SNAP-AITM-4i: -50 to +50 mV	9	9	32	4	mV	-55.0	-50.0	50.0	55.0
SNAP-AITM-4i: -25 to +25 mV	67	43	32	4	mV	-27.5	-25.0	25.0	27.5
SNAP-AITM-4i: Type B Thermocouple	24	18	32	4	Degrees C	42.0	42.0	1820.0	1820.0
SNAP-AITM-4i: Type C Thermocouple	32	20	32	4	Degrees C	0.0	0.0	2320.0	2320.0
SNAP-AITM-4i: Type D Thermocouple	33	21	32	4	Degrees C	0.0	0.0	2320.0	2320.0
SNAP-AITM-4i: Type E Thermocouple	19	13	32	4	Degrees C	-270.0	-270.0	1000.0	1000.0
SNAP-AITM-4i: Type G Thermocouple	31	1F	32	4	Degrees C	0.0	0.0	2320.0	2320.0
SNAP-AITM-4i: Type J Thermocouple	5	5	32	4	Degrees C	-210.0	-210.0	1200.0	1200.0
SNAP-AITM-4i: Type K Thermocouple	8	8	32	4	Degrees C	-270.0	-270.0	1372.0	1372.0
SNAP-AITM-4i: Type N Thermocouple	30	1E	32	4	Degrees C	-270.0	-270.0	1300.0	1300.0
SNAP-AITM-4i: Type R Thermocouple	17	11	32	4	Degrees C	-50.0	-50.0	1768.0	1768.0
SNAP-AITM-4i: Type S Thermocouple	23	17	32	4	Degrees C	-50.0	-50.0	1768.0	1768.0
SNAP-AITM-4i: Type T Thermocouple	18	12	32	4	Degrees C	-270.0	-270.0	400.0	400.0
<b>SNAP-AITM-8: -75 to +75 mV</b>	68	44	4F	8	mV	-82.5	-75.0	75.0	82.5
SNAP-AITM-8: -50 to +50 mV	9	9	4F	8	mV	-55.0	-50.0	50.0	55.0
SNAP-AITM-8: -25 to +25 mV	67	43	4F	8	mV	-27.5	-25.0	25.0	27.5

Part Number & Description	Channel Type (Dec)	Channel Type (Hex)	Module Type (Hex)	Channels per Module	Default Unit of Measurement	Underrange	Low Scale	Full Scale	Overrange
SNAP-AITM-8: Type B Thermocouple	24	18	4F	8	Degrees C	42.0	42.0	1820.0	1820.0
SNAP-AITM-8: Type C Thermocouple	32	20	4F	8	Degrees C	0.0	0.0	2320.0	2320.0
SNAP-AITM-8: Type D Thermocouple	33	21	4F	8	Degrees C	0.0	0.0	2320.0	2320.0
SNAP-AITM-8: Type E Thermocouple	19	13	4F	8	Degrees C	-270.0	-270.0	1000.0	1000.0
SNAP-AITM-8: Type G Thermocouple	31	1F	4F	8	Degrees C	0.0	0.0	2320.0	2320.0
SNAP-AITM-8: Type J Thermocouple	5	5	4F	8	Degrees C	-210.0	-210.0	1200.0	1200.0
SNAP-AITM-8: Type K Thermocouple	8	8	4F	8	Degrees C	-270.0	-270.0	1372.0	1372.0
SNAP-AITM-8: Type N Thermocouple	30	1E	4F	8	Degrees C	-270.0	-270.0	1300.0	1300.0
SNAP-AITM-8: Type R Thermocouple	17	11	4F	8	Degrees C	-50.0	-50.0	1768.0	1768.0
SNAP-AITM-8: Type S Thermocouple	23	17	4F	8	Degrees C	-50.0	-50.0	1768.0	1768.0
SNAP-AITM-8: Type T Thermocouple	18	12	4F	8	Degrees C	-270.0	-270.0	400.0	400.0
<b>SNAP-AITM-8-FM: -75 to +75 mV</b>	68	44	4F	8	mV	-82.5	-75.0	75.0	82.5
SNAP-AITM-8-FM: -50 to +50 mV	9	9	4F	8	mV	-55.0	-50.0	50.0	55.0
SNAP-AITM-8-FM: -25 to +25 mV	67	43	4F	8	mV	-27.5	-25.0	25.0	27.5
SNAP-AITM-8-FM: Type B Thermocouple	24	18	4F	8	Degrees C	42.0	42.0	1820.0	1820.0
SNAP-AITM-8-FM: Type C Thermocouple	32	20	4F	8	Degrees C	0.0	0.0	2320.0	2320.0
SNAP-AITM-8-FM: Type D Thermocouple	33	21	4F	8	Degrees C	0.0	0.0	2320.0	2320.0
SNAP-AITM-8-FM: Type E Thermocouple	19	13	4F	8	Degrees C	-270.0	-270.0	1000.0	1000.0
SNAP-AITM-8-FM: Type G Thermocouple	31	1F	4F	8	Degrees C	0.0	0.0	2320.0	2320.0
SNAP-AITM-8-FM: Type J Thermocouple	5	5	4F	8	Degrees C	-210.0	-210.0	1200.0	1200.0
SNAP-AITM-8-FM: Type K Thermocouple	8	8	4F	8	Degrees C	-270.0	-270.0	1372.0	1372.0
SNAP-AITM-8-FM: Type N Thermocouple	30	1E	4F	8	Degrees C	-270.0	-270.0	1300.0	1300.0
SNAP-AITM-8-FM: Type R Thermocouple	17	11	4F	8	Degrees C	-50.0	-50.0	1768.0	1768.0
SNAP-AITM-8-FM: Type S Thermocouple	23	17	4F	8	Degrees C	-50.0	-50.0	1768.0	1768.0
SNAP-AITM-8-FM: Type T Thermocouple	18	12	4F	8	Degrees C	-270.0	-270.0	400.0	400.0
<b>SNAP-AITM2: -50 to +50 mV</b>	9	9	09	2	mV	-55.0	-50.0	50.0	55.0
SNAP-AITM2: -25 to +25 mV	67	43	09	2	mV	-27.5	-25.0	25.0	27.5
SNAP-AITM2: Type B Thermocouple	24	18	09	2	Degrees C	42.0	42.0	1820.0	1820.0
SNAP-AITM2: Type C Thermocouple	32	20	09	2	Degrees C	0.0	0.0	2320.0	2320.0
SNAP-AITM2: Type D Thermocouple	33	21	09	2	Degrees C	0.0	0.0	2320.0	2320.0
SNAP-AITM2: Type G Thermocouple	31	1F	09	2	Degrees C	0.0	0.0	2320.0	2320.0
SNAP-AITM2: Type N Thermocouple	30	1E	09	2	Degrees C	-270.0	-270.0	1300.0	1300.0
SNAP-AITM2: Type R Thermocouple	17	11	09	2	Degrees C	-50.0	-50.0	1768.0	1768.0
SNAP-AITM2: Type S Thermocouple	23	17	09	2	Degrees C	-50.0	-50.0	1768.0	1768.0
SNAP-AITM2: Type T Thermocouple	18	12	09	2	Degrees C	-270.0	-270.0	400.0	400.0
<b>SNAP-AITM2-i: -50 to +50 mV</b>	9	9	21	2	mV	-55.0	-50.0	50.0	55.0

Part Number & Description	Channel Type (Dec)	Channel Type (Hex)	Module Type (Hex)	Channels per Module	Default Unit of Measurement	Underrange	Low Scale	Full Scale	Overrange
SNAP-AITM2-i: -25 to +25 mV	67	43	21	2	mV	-27.5	-25.0	25.0	27.5
SNAP-AITM2-i: Type B Thermocouple	24	18	21	2	Degrees C	42.0	42.0	1820.0	1820.0
SNAP-AITM2-i: Type C Thermocouple	32	20	21	2	Degrees C	0.0	0.0	2320.0	2320.0
SNAP-AITM2-i: Type D Thermocouple	33	21	21	2	Degrees C	0.0	0.0	2320.0	2320.0
SNAP-AITM2-i: Type G Thermocouple	31	1F	21	2	Degrees C	0.0	0.0	2320.0	2320.0
SNAP-AITM2-i: Type N Thermocouple	30	1E	21	2	Degrees C	-270.0	-270.0	1300.0	1300.0
SNAP-AITM2-i: Type R Thermocouple	17	11	21	2	Degrees C	-50.0	-50.0	1768.0	1768.0
SNAP-AITM2-i: Type S Thermocouple	23	17	21	2	Degrees C	-50.0	-50.0	1768.0	1768.0
SNAP-AITM2-i: Type T Thermocouple	18	12	21	2	Degrees C	-270.0	-270.0	400.0	400.0
<b>SNAP-AIV</b> : -10 to +10 VDC	12	C	12	2	VDC	-11.0	-10.0	10.0	11.0
SNAP-AIV: -5 to +5 VDC	11	B	12	2	VDC	-5.5	-5.0	5.0	5.5
<b>SNAP-AIV-i</b> : -10 to +10 VDC	12	C	23	2	VDC	-11.0	-10.0	10.0	11.0
SNAP-AIV-i: -5 to +5 VDC	11	B	23	2	VDC	-5.5	-5.0	5.0	5.5
<b>SNAP-AIV-4</b> : -10 to +10 VDC	12	C	41	4	VDC	-11.0	-10.0	10.0	11.0
SNAP-AIV-4: -5 to +5 VDC	11	B	41	4	VDC	-5.5	-5.0	5.0	5.5
<b>SNAP-AIV-8</b> : -10 to +10 VDC	12	C	4B	8	VDC	-11.0	-10.0	10.0	11.0
SNAP-AIV-8: -5 to +5 VDC	11	B	4B	8	VDC	-5.5	-5.0	5.0	5.5
<b>SNAP-AIV-32</b> : -10 to +10 VDC	12	C	4E	32	VDC	-11.0	-10.0	10.0	11.0
SNAP-AIV-32: -5 to +5 VDC	11	B	4E	32	VDC	-5.5	-5.0	5.0	5.5
<b>SNAP-AIV-32-FM</b> : -10 to +10 VDC	12	C	4E	32	VDC	-11.0	-10.0	10.0	11.0
SNAP-AIV-32-FM: -5 to +5 VDC	11	B	4E	32	VDC	-5.5	-5.0	5.0	5.5
<b>SNAP-AIV2-i</b> : -100 to +100 VDC	72	48	24	2	VDC	-110.0	-100.0	100.0	110.0
SNAP-AIV2-i: -50 to +50 VDC	73	49	24	2	VDC	-55.0	-50.0	50.0	55.0
<b>SNAP-AIVRMS</b> : 0–250 VAC/VDC	70	46	70	2	VAC/VDC	0.0	0.0	250.0	275.0
<b>SNAP-AIVRMS-i</b> : 0–250 VAC/VDC	70	46	28	2	VAC/VDC	0.0	0.0	250.0	275.0
<b>SNAP-AIVRMS-i-FM</b> : 0–250 VAC/VDC	70	46	28	2	VAC/VDC	0.0	0.0	250.0	275.0
<b>SNAP-AIR40K-4</b> : 0 to 40K Ohms	74	4A	43	4	Ohms	0	0	40,000	44,000
SNAP-AIR40K-4: 0 to 20K Ohms	75	4B	43	4	Ohms	0	0	20,000	22,000
SNAP-AIR40K-4: 0 to 10K Ohms	76	4C	43	4	Ohms	0	0	10,000	11,000
SNAP-AIR40K-4: 0 to 5K Ohms	77	4D	43	4	Ohms	0	0	5000	5500
<b>SNAP-AIR400K-8</b> : 0 to 400K Ohms	105	69	54	8	Ohms	0	0	400,000	440,000
SNAP-AIR400K-8: 0 to 400K Autorange	188	BC	54	8	Ohms	0	0	400,000	440,000
SNAP-AIR400K-8: 0 to 200K Ohms	106	6A	54	8	Ohms	0	0	200,000	220,000
SNAP-AIR400K-8: 0 to 100K Ohms	107	6B	54	8	Ohms	0	0	100,000	110,000
SNAP-AIR400K-8: 0 to 50K Ohms	108	6C	54	8	Ohms	0	0	50,000	55,000
SNAP-AIR400K-8: 0 to 40K Ohms	74	4A	54	8	Ohms	0	0	40,000	44,000

Part Number & Description	Channel Type (Dec)	Channel Type (Hex)	Module Type (Hex)	Channels per Module	Default Unit of Measurement	Underrange	Low Scale	Full Scale	Overrange
SNAP-AIR400K-8: 0 to 20K Ohms	75	4B	54	8	Ohms	0	0	20,000	22,000
SNAP-AIR400K-8: 0 to 10K Ohms	76	4C	54	8	Ohms	0	0	10,000	11,000
SNAP-AIR400K-8: 0 to 5K Ohms	77	4D	54	8	Ohms	0	0	5000	5500
SNAP-AIR400K-8: 0 to 4K Ohms	38	26	54	8	Ohms	0	0	4000	4400
SNAP-AIR400K-8: 0 to 2K Ohms	39	27	54	8	Ohms	0	0	2000	2200
SNAP-AIR400K-8: 0 to 1K Ohms	40	28	54	8	Ohms	0	0	1000	1100
SNAP-AIR400K-8: 0 to 500 Ohms	41	29	54	8	Ohms	0	0	500	550
<b>SNAP-pH/ORP: -1 to +1 VDC</b>	78	4E	25	2	VDC	-1.1	-1.0	1.0	1.1
SNAP-pH/ORP: 0–14 pH	79	4F	25	2	pH	-1.4	0.0	14.0	15.4
SNAP-pH/ORP: -0.5 to +0.5 VDC	80	50	25	2	VDC	-0.55	-0.5	0.5	0.55
<b>SNAP-PID-V</b>	99	63	D0	4	Percent	0	0	100.0	110.0

\* The SNAP-AIPM module monitors one device from channel 0 (volts) and channel 1 (amps). Channels 2 and 3 return calculated values. The SNAP-AIPM-3 and SNAP-AIPM-3V monitor three phases from channels 0,4, & 8 (volts) and channels 1,5, & 9 (amps). All other channels return calculated values. See the [SNAP AIPM Modules Data Sheet](#) (form 1453) for details.

Analog Output Modules

Use this data for configuring point types and features (see [page 178](#)).

Part Number & Description	Channel Type (Dec)	Channel Type (Hex)	Module Type (Hex)	Channels per Module	Default Unit of Measurement	Underrange	Low scale	Full scale	Overrange
SNAP-AOA-3: 4–20 mA	131	83	83	1	mA	4.0	4.0	20.0	20.0
SNAP-AOV-5: 0–10 VDC	133	85	85	1	VDC	0.0	0.0	10.0	10.0
SNAP-AOA-23: 4–20 mA	163	A3	A3	2	mA	4.0	4.0	20.0	20.0
SNAP-AOA-23-iSRC: 4–20 mA	163	A3	B3	2	mA	4.0	4.0	20.0	20.0
SNAP-AOA-23-iSRC-FM: 4–20 mA	163	A3	B3	2	mA	4.0	4.0	20.0	20.0
SNAP-AOA-23-iH: 4–20 mA	163	A3	AB	2	mA	4.0	4.0	20.0	20.0
SNAP-AOV-25: 0–10 VDC	165	A5	A5	2	VDC	0.0	0.0	10.0	10.0
SNAP-AOV-27: -10 to +10 VDC	167	A7	A7	2	VDC	-10.0	-10.0	10.0	10.0
SNAP-AOA-28: 0–20 mA	168	A8	A8	2	mA	0.0	0.0	20.0	20.0
SNAP-AOVA-8: 0–5 VDC	144	90	CF	8	VDC	0.0	0.0	5.0	5.0
SNAP-AOVA-8: 0–10 VDC	145	91	CF	8	VDC	0.0	0.0	10.0	10.0
SNAP-AOVA-8: -5 to +5 VDC	146	92	CF	8	VDC	-5.0	-5.0	5.0	5.0
SNAP-AOVA-8: -10 to +10 VDC	147	93	CF	8	VDC	-10.0	-10.0	10.0	10.0
SNAP-AOVA-8: 4–20 mA	148	94	CF	8	mA	4.0	4.0	20.0	20.0

Part Number & Description	Channel Type (Dec)	Channel Type (Hex)	Module Type (Hex)	Channels per Module	Default Unit of Measurement	Underrange	Low scale	Full scale	Overrange
SNAP-AOVA-8: 0–20 mA	149	95	CF	8	mA	0.0	0.0	20.0	20.0
SNAP-AOD-29: TPO 5–60 VDC	169	A9	A9	2	Percent	n/a	0.0	100.0	n/a
SNAP-AOD-29-HFi: TPO 2.5–24 VDC	131	83	B9	2	Percent	n/a	0.0	100.0	n/a

PAC-R  
EB  
UIO  
EIO  
SIO

Configuring Serial Modules in the Inspect Window

(Not available on SB brains) Using the Inspect window you can change many previously configured parameters for a serial module. However, keep in mind that any changes you make in the Inspect window are sent directly to the controller or I/O unit and cannot be saved to a configuration file. Therefore, you should save the configuration to flash memory. For instructions, see [“Saving Configuration to a Device’s Flash Memory” on page 212](#). To use a configuration file, see [Chapter 2: Configuring Devices](#).

1. In the PAC Manager main window, click the Inspect button .
2. In the Inspect Opto 22 Device window, type the IP address of the I/O unit (or choose it from the drop-down list).
3. Click Communications and then click the type of module from the submenu.
4. Choose the module’s position number from the drop-down list.

Data for this module is shown in the window.

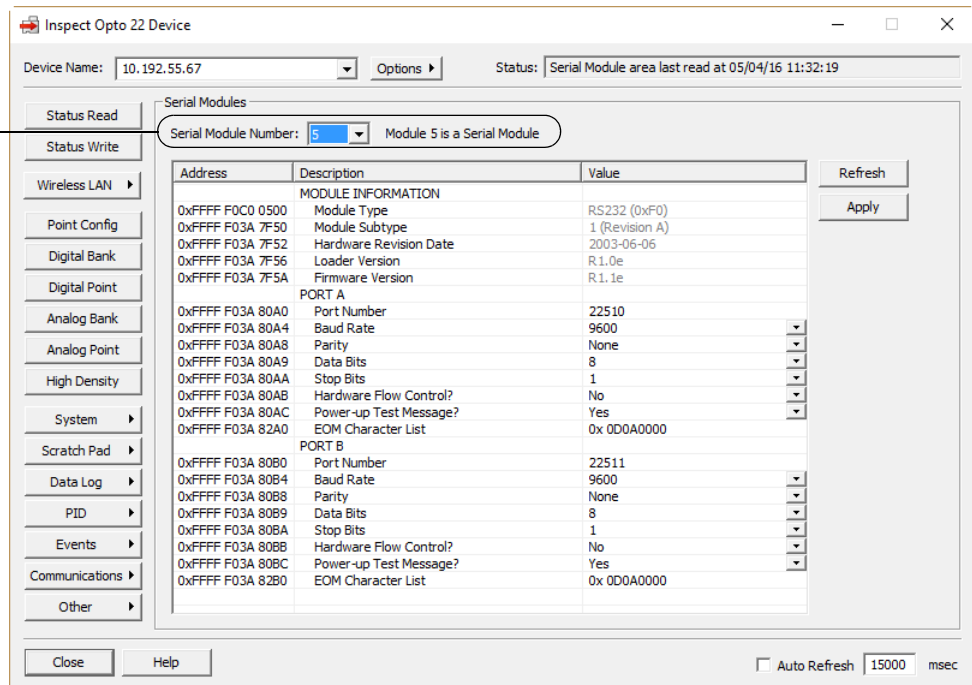

For help in understanding or changing data, see the following sections:

- [“Configuring RS-232 and RS-485/422 Serial Communication Modules” on page 60](#)
- [“Configuring Wiegand Modules” on page 65](#)
- [“Configuring PID Modules” on page 67](#)
- [“Configuring Profibus Modules” on page 68](#)

- “Configuring SSI (Serial Synchronous Interface) Modules” on page 69
- “Configuring CAN Modules” on page 71
- “Configuring HART Modules” on page 75

See also the [SNAP Serial Communication Module User’s Guide](#) (form 1191).

5. To save configuration to flash memory, see “Saving Configuration to a Device’s Flash Memory” on page 212.

**PAC-R  
EB  
SB  
UIO  
EIO**

### Configuring, Viewing, or Changing PID Loops

For information about PID loops, see [page 78](#). PIDs are normally configured in a configuration file following the steps on [page 80](#). However, you can also configure, view, or change them using PAC Manager’s Inspect window. (Remember that changes made here cannot be saved to a configuration file.)

1. In the PAC Manager main window, click the Inspect button .

The Inspect window opens.

- If you haven’t used the Inspect window before, no data is displayed in the Status Read pane.
- If you *have* used the Inspect window before, the last device you inspected is shown in the Device Name field, and current Status Read information appears in the window.
- If you have configured other devices, they are listed in alphabetical order in the drop-down list.

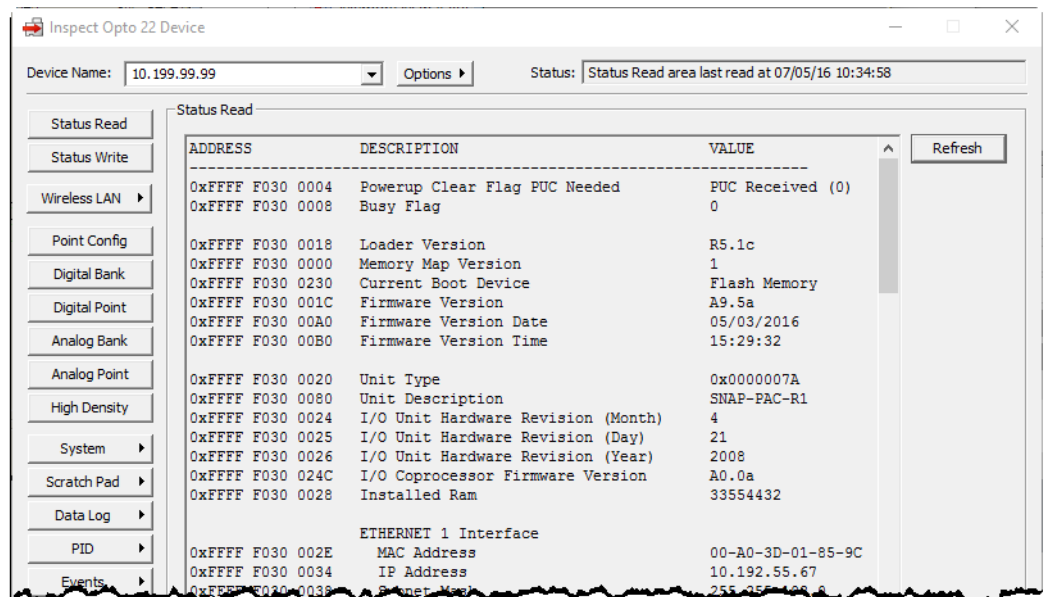

- If you have configured six or more devices, the Inspect window provides two additional time-saving features: Next and Back navigation buttons (to navigate back and forth through the alphabetized list



of devices), and a list of the five most recently inspected devices (displayed at the top of the drop-down list).

Next and Back navigation buttons and Most Recently Used list are displayed when you have six or more devices configured.

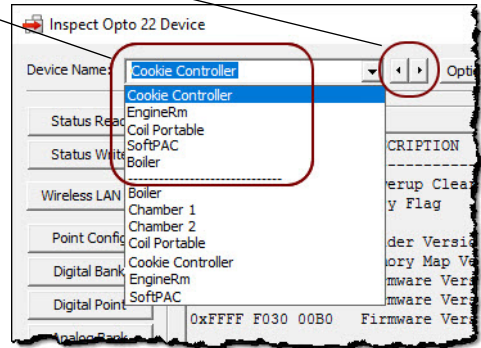

2. In the Device Name field, type the name (or IP address) of the I/O unit (or choose it from the drop-down list). Click PID and choose PID Loops from the submenu.

Information for this PID loop is shown in the window.

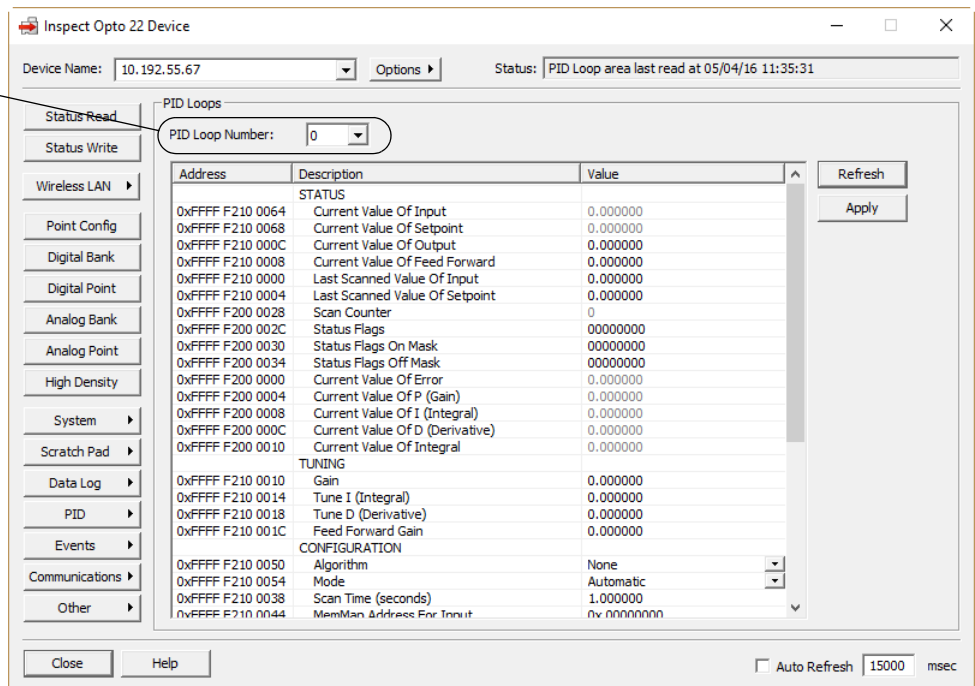

3. From the drop-down list, choose the PID loop number you want to configure, view, or change. Existing PID loops are indicated by an asterisk (\*) next to the number.
4. To configure or change the PID, click inside the cell in the Value column and type the new value or choose it from a drop-down list, if one is available. When you have finished making changes, click Apply to send them to the I/O unit.

*NOTE: If you are using PAC Control, it is easiest to tune PID loops in your PAC Control strategy running in Debug mode. For details, see the [PAC Control User's Guide](#) (form 1700).*

For information on memory map addresses and what they contain, see the [OptoMMP Protocol Guide](#) (form 1465).

## READING AND WRITING TO POINTS

PAC-R  
EB  
SB  
UIO  
EIO  
SIO  
E1  
E2

You can use PAC Manager to read or change I/O point values. **You must configure points before you can read or write to them.**

**CAUTION:** If you are using PAC Control, reading and writing is normally done in the PAC Control strategy logic or in Debug mode. If you use the steps in this section to write to an I/O unit, be very careful you do not interfere with strategy logic.

1. In the PAC Manager main window, click the Inspect button  .

The Inspect window opens.

- If you haven't used the Inspect window before, no data is displayed in the Status Read pane.
- If you *have* used the Inspect window before, the last device you inspected is shown in the Device Name field, and current Status Read information appears in the window.
- If you have configured other devices, they are listed in alphabetical order in the drop-down list.

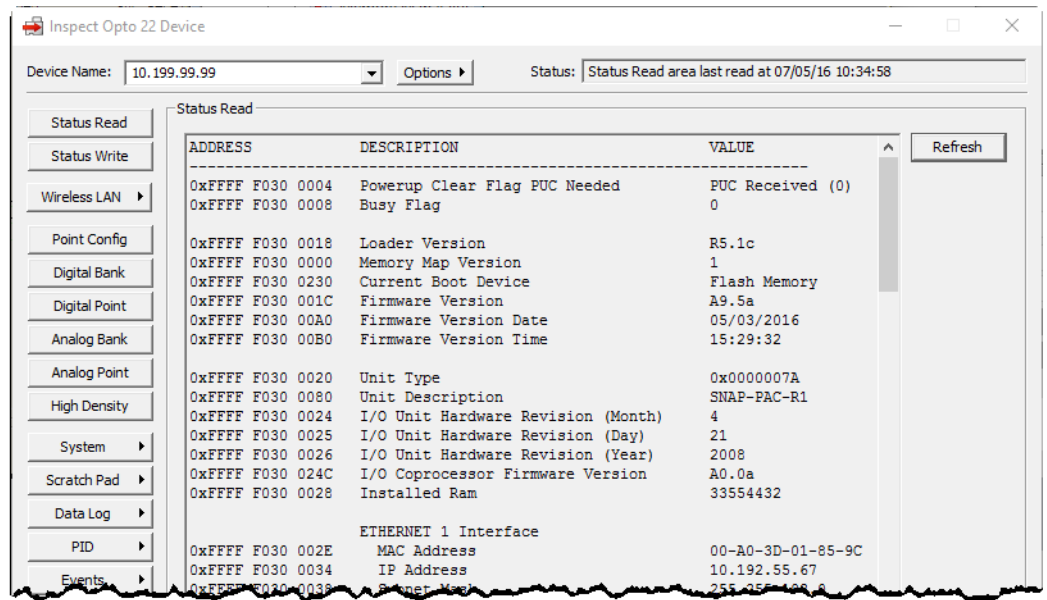

- If you have configured six or more devices, the Inspect window provides two additional time-saving features: Next and Back navigation buttons (to navigate back and forth through the alphabetized list

of devices), and a list of the five most recently inspected devices (displayed at the top of the drop-down list).

Next and Back navigation buttons and Most Recently Used list are displayed when you have six or more devices configured.

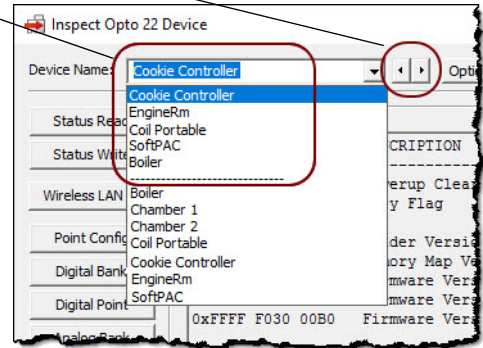

2. In the Device Name field, type the name (or IP address) of the I/O unit (or choose it from the drop-down list).
3. Click Digital Point or Analog Point, depending on the type of point you want to read or write to. For digital points, see ["Reading and Writing to Digital Points."](#) For analog points, see [page 195](#).

PAC-R  
EB  
SB  
UIO  
EIO  
SIO  
E1

### Reading and Writing to Digital Points

*NOTE: For points on high-density digital modules, you can read or write to individual points using the steps in this section. To read or write to all points at one time, see ["Reading and Writing to SNAP High-Density Digital Points"](#) on [page 203](#).*

#### Digital Input Points

Here's an example showing a SNAP digital input point. Module position numbers are shown near the top of the Inspect Opto 22 Device window, with the point numbers for each module listed just below the position number. For more information on locating modules and points, see ["Referencing I/O Points"](#) on [page 173](#).

## READING AND WRITING TO POINTS

Module position number

Point numbers for this module. Point 1 is currently being read here.

To update values, click the Refresh button.

Since point 1 is an input point, you can turn counting on and off or clear counters and latches.

1. Click the point number you want to read or write to.  
The current values for that point number appear in the Read Area. The Status data at the top right corner of the window shows the date and time values were last read. The Read Area and the Write Area change depending upon the point type.
2. To turn counting on or off or to clear counters and latches, click the buttons in the Counter State and Clear areas near the bottom of the window. (For more information on these features, see [page 87](#).)

Your changes are immediately sent to the I/O unit, and the window is updated to reflect your changes.

### Digital Output Points

The following example shows a digital output point.

Current values for point 1 on this digital output module. Click the Refresh button to update values.

Change point state on an output point by clicking a button in the Write Area.

1. Click the point number you want to read or write to.
2. The current values for that point number appear in the Read Area. The Status data at the top right corner of the window shows the date and time values were last read. The Read Area and the Write Area change depending upon the point type.
3. To turn an output point on or off, click a button in the Write Area.

The change is immediately sent to the I/O unit, and the window is updated.

PAC-R  
EB  
SB  
UIO  
EIO  
SIO  
E2

## Reading and Writing to Analog Points

### Analog Input Points

This example shows an analog input point. Module position numbers are shown near the top of the Inspect Opto 22 Device window, with the point numbers for each module listed just below the position number. For more on locating modules and points, see [“Referencing I/O Points” on page 173](#).

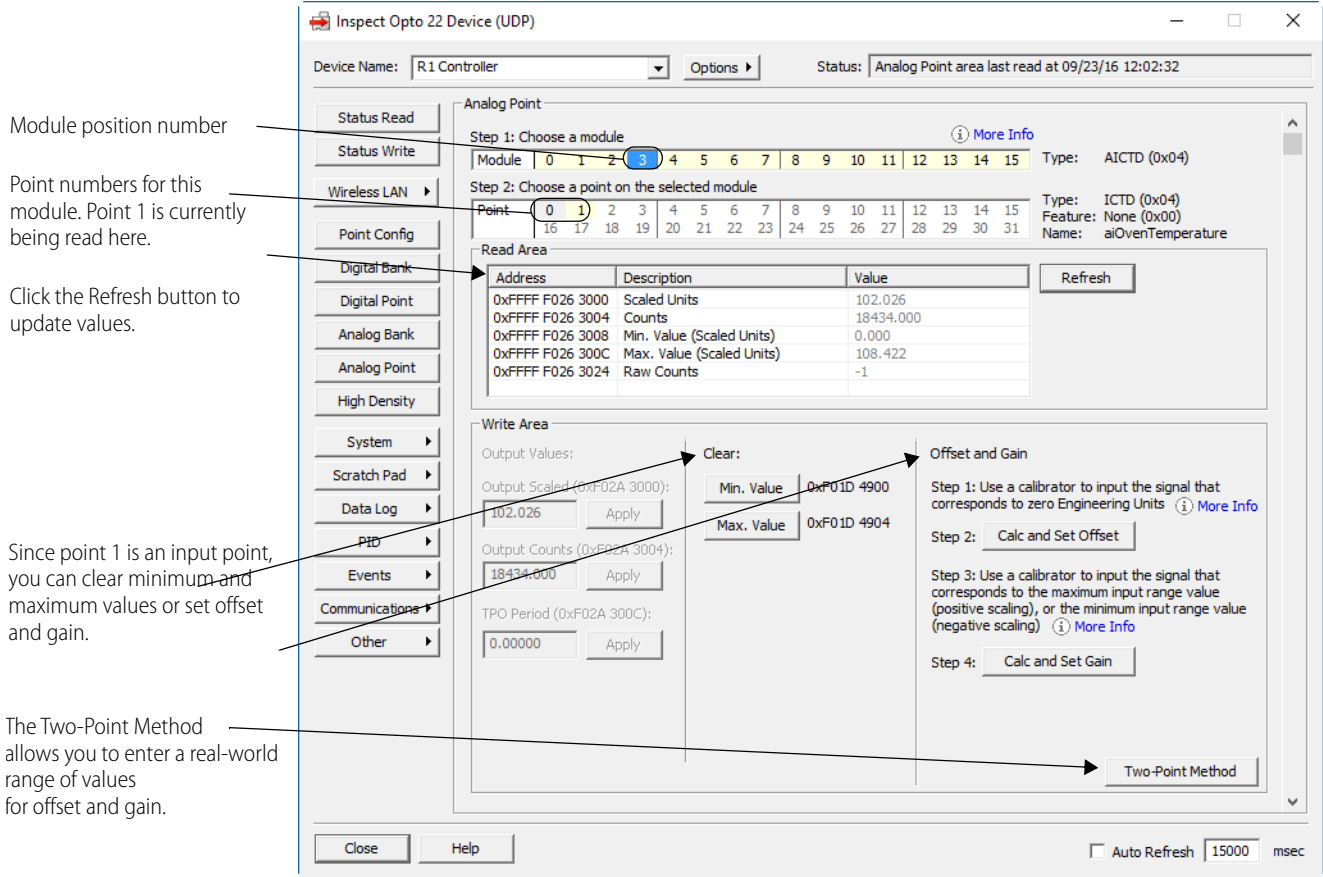

1. Click the point number you want to read or write to.  
The current values for that point number appear in the Read Area.
2. To clear minimum and maximum values, click the buttons in the Clear area (see page 89 for information).
3. To set offset and gain, use the default method (described below), or click the Two-Point Method and follow the steps on page 198.

Your changes are immediately sent to the I/O unit, and the window is updated to reflect your changes.

**PAC-R**  
**EB**  
**SB**  
**UIO**  
**EIO**  
**SIO**

### Calibrating Offset and Gain Using the Default Method

You adjust an analog point's *offset* and *gain* to ensure that the measured values are accurate. This section describes how to have the offset and gain automatically calculated and set for you.

*NOTE:* See "Calculating Offset and Gain Using the Two-Point Method" on page 198 if:

- You don't have access to a calibrator, or
- The point uses inverted scaling and your device has PAC firmware R9.5b or lower. (In inverted scaling, the lower scaled value is greater than the upper scaled value.)

Starting with the introduction of SNAP-B3000-ENET, all SNAP PAC brains (including SBs), SNAP Ethernet I/O units, and E2 brain boards can automatically calculate offset and gain for analog input points. If a -50 mV to +50 mV input receives signals that are slightly off (for example, not exactly -50 mV at the lowest point), the offset and gain can be calculated so that values appear accurately when read.

Offset and gain values affect engineering units (EU). For a temperature input, engineering units are in degrees C or F, depending on how the I/O unit is configured.

**IMPORTANT:** To calibrate the point, the I/O unit must be turned on and attached to the network, and you must have access to the I/O unit in order to use the calibrator. For points on a SNAP PAC SB-series brain, connect directly via serial or through the controller via Ethernet. (See [page 39](#) for details.)

Save the configuration to flash so that it is not lost when power is turned off. Since each calibration is for a specific point on a specific I/O unit, the result cannot be saved to the configuration file and cannot be sent to any other I/O unit.

First, calculate offset, and then calculate gain. The offset must be calculated at the signal corresponding to zero engineering units (EU), and the gain must be calculated at the signal corresponding to the point's maximum input range value (or, for inverted scaling, the point's minimum input range value—in inverted scaling, the lower scaled value is greater than the upper scaled value).

1. In Inspect mode, click the Analog Point button.
2. Click the module and analog input point you want to calibrate.

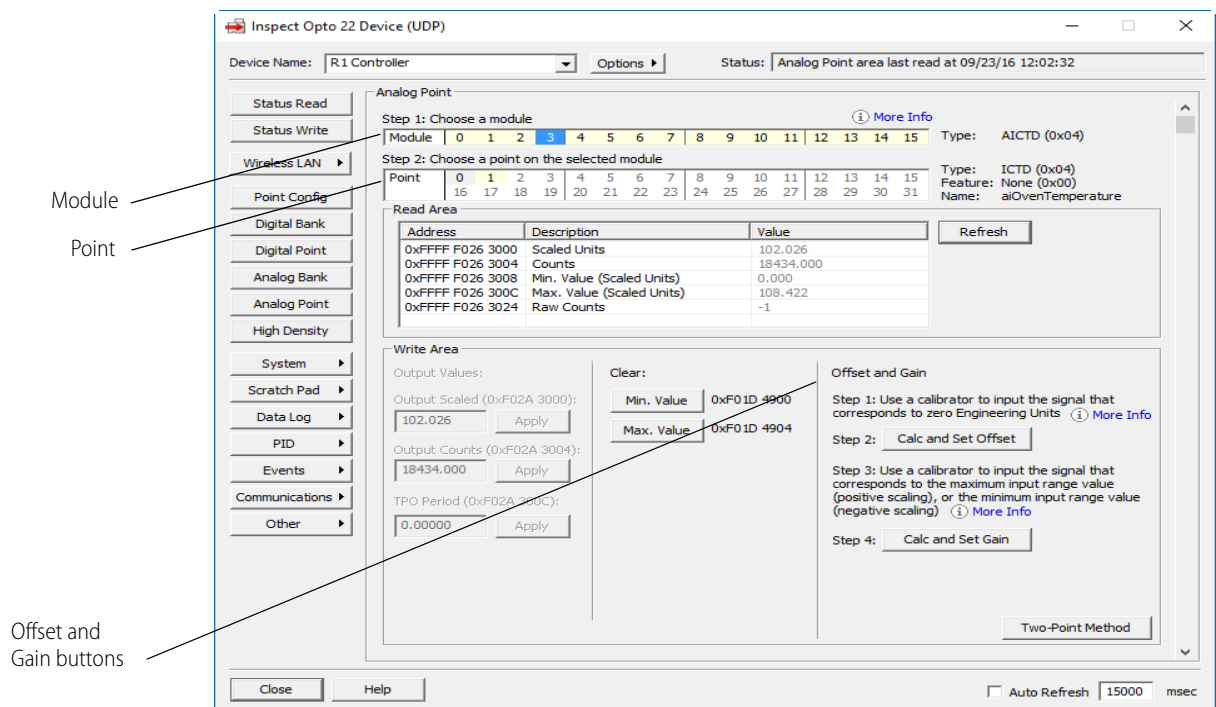

3. On the analog input point, use a calibrator to input the signal that corresponds to zero Engineering Units (EU).

Example 1: SNAP-AIV (-10 to +10 VDC) configured with default scaling  
zero EU = 0 VDC

Example 2: SNAP-AIV (-10 to +10 VDC) configured with custom scaling

	Actual	Scaled
Units	VDC	PSI
Lower	-10	0*
Upper	+10	100

\*Zero EU is 0 PSI, which corresponds to a -10 VDC field signal

4. Click the Calc and Set Offset button.

5. Use the calibrator to input the signal corresponding to the maximum input range value—or for inverted scaling, to the minimum input range value—for the configured point type.

(In inverted scaling, the lower scaled value is greater than the upper scaled value.)

For precise values, refer to the configured Point Type or see the module's data sheet.

Example:

SNAP-AIV module; Point Type of -10 to +10 VDC:

Maximum Input Range Value = +10 VDC

For inverted scaling, Minimum Input Range Value = -10 VDC

6. Click the Calc and Set Gain button.

*NOTE: To store offset and gain values permanently, you must save the change to flash when you send the configuration data to the I/O unit (see page 83).*

### Calculating Offset and Gain Using the Two-Point Method

You adjust an analog point's *offset* and *gain* to ensure that the measured values are accurate.

- Offset represents the low scale offset from the correct value.
- Gain represents the slope of the scaling equation.

The two-point method allows you to use any real-world range of Engineering Units to calculate offset and gain. Use this method when it isn't convenient or possible to input a signal that equates to either the zero-scale or full-scale engineering units for a module's point type. Also, you must use the two-point method if the analog point you're calibrating uses inverted scaling and you're using PAC firmware R9.5b or lower. (PAC firmware R9.5c and higher can automatically calculate offset and gain for analog points that use inverted scaling.)

When using the two-point method, choose two points that are as far apart as possible.

1. If it isn't already open, open the Inspect Opto 22 Device window for the point you want to calibrate (Tools > Inspect | Analog Point button).
2. Click the Two-Point Method button in the Offset and Gain area in the bottom-right corner of the Write Area.

*NOTE: You may have to scroll down to see the button.*

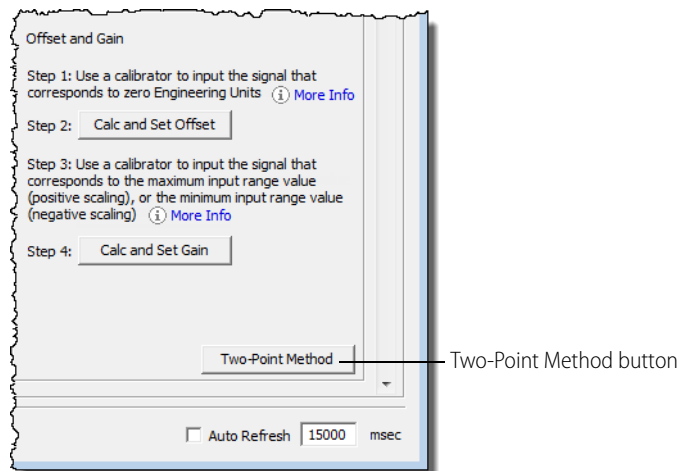

3. Use a calibrator to input a signal corresponding to the low end of the desired range.



For example, a SNAP-AIV module has a range of  $-10$  to  $+10$  VDC, so you might choose a range of 1.0 to 8.0 if it's convenient. In that case, you would use the calibrator to input a low end of 1.0 VDC on the input point.

*NOTE: For best results, choose two points that are as far apart as possible.*

- Note the signal's value on the calibrator and type this value in the Expected Value field.

The screenshot shows the 'Write Area' interface with the following sections:

- Low Values:**
  - Step 1: Use calibrator to input a signal corresponding to the low end of the desired range.
  - Step 2: Enter the value the input should return in response to this signal.
  - Expected Value:
  - Step 3: Read the value the input is currently returning in response to this signal.
  - Actual Value:
- High Values:**
  - Step 4: Use calibrator to input a signal corresponding to the high end of the desired range.
  - Step 5: Enter the value the input should return in response to this signal.
  - Expected Value:
  - Step 6: Read the value the input is currently returning in response to this signal.
  - Actual Value:
- Offset and Gain:**
  - Step 7: Calculate offset and gain required to produce given expected values.
  - Calculated Offset:  Calculated Gain:
  - 
  - Step 8: Send the offset and gain to the device.
  -

Annotations: 'Expected Value' points to the first 'Expected Value' field. 'Read button' points to the 'Read' button in the 'Low Values' section.

- Click the Read button to read the value that the input point is returning in response to this signal. This value appears in the Actual Value field.
- Use the calibrator again to input a signal corresponding to the high end of the desired range. Using the SNAP-AIV example in step 2, for the high end you would use the calibrator to input 8.0 VDC on the input point.
- Type the Expected Value for the high-end value, and then click Read.
- Click the Calculate button to calculate the offset and gain.
- Click Send Values to send the offset and gain to the device.
- Save the settings to flash memory to make sure that the data is not lost when power to the device is turned off. See [“Saving Configuration to a Device’s Flash Memory” on page 212](#).

### Analog Output Points

The following example shows an analog output point.

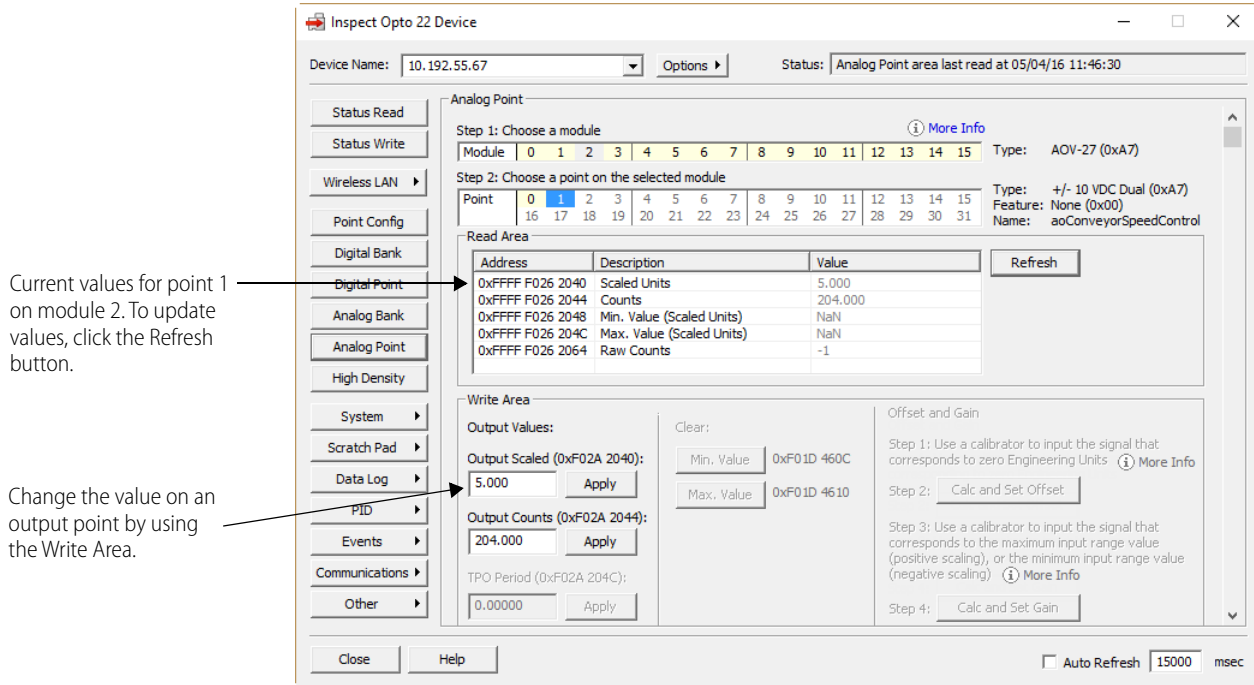

1. Click the point number you want to read or write to.  
The current values for that point number appear in the Read Area.
2. To change the value of an output point, enter the value in the Write Area (either Scaled or Counts) and click Apply.  
The change is immediately sent to the I/O unit, and the window is updated.

PAC-R  
EB  
SB  
UIO  
EIO  
SIO  
E1  
E2

### Reading Analog and Digital Banks

You can use PAC Manager to read a bank of points at one time. (Currently it is not possible to write to a bank of points using PAC Manager.) **You must configure points before you can read them.**

*NOTE: Bank reading cannot be done on digital or analog modules containing more than four points. To read or write to all points on a high-density digital module, see [page 203](#).*

1. In the PAC Manager main window, click the Inspect button .  
The Inspect window opens.
  - If you haven't used the Inspect window before, no data is displayed in the Status Read pane.
  - If you *have* used the Inspect window before, the last device you inspected is shown in the Device Name field, and current Status Read information appears in the window.

- If you have configured other devices, they are listed in alphabetical order in the drop-down list.

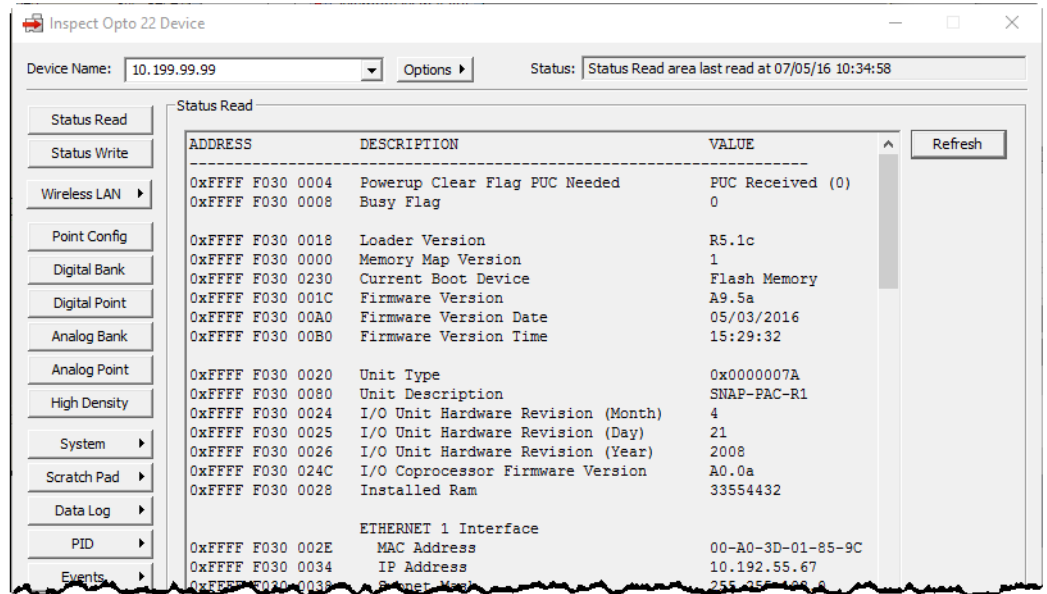

- If you have configured six or more devices, the Inspect window provides two additional time-saving features: Next and Back navigation buttons (to navigate back and forth through the alphabetized list of devices), and a list of the five most recently inspected devices (displayed at the top of the drop-down list).

Next and Back navigation buttons and Most Recently Used list are displayed when you have six or more devices configured.

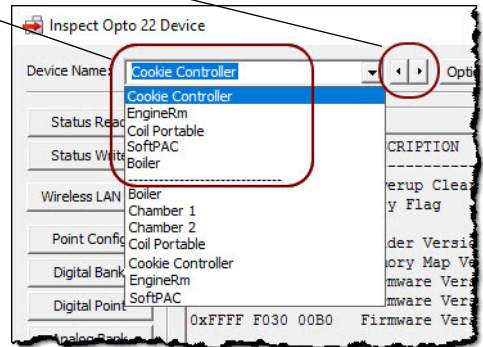

2. In the Device Name field, type the name (or IP address) of the I/O unit (or choose it from the drop-down list). Click Digital Bank or Analog Bank.

See also:

Digital Bank Window

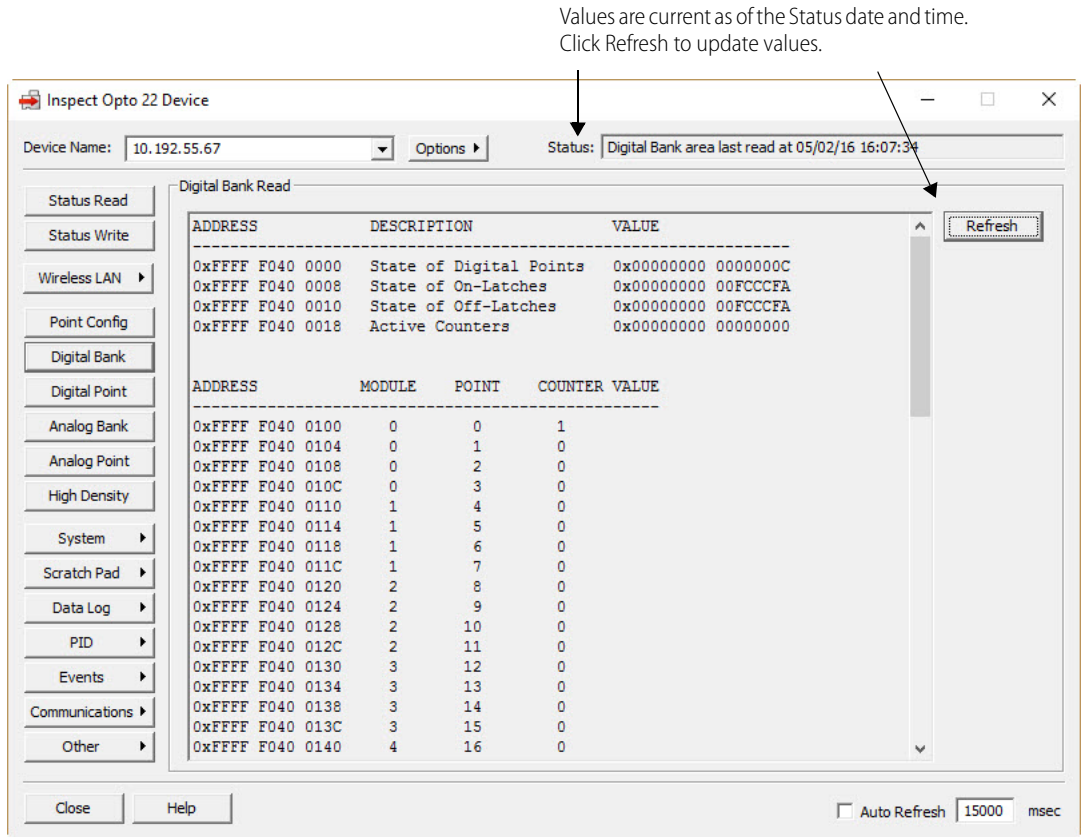

Remember that values for points on high-density digital modules are not included.

You can copy part or all of the data in this window and paste it into another file, such as a text file or email. Just highlight what you want to copy, right-click it, and choose Copy from the pop-up menu (or use Ctrl+C). To highlight all data in the window, right click in the window and choose Select All.

**Data Formats.** Most digital bank data is in the form of a mask. For example, the State of Digital Points value shown in the previous figure is this mask:

0x00000000 0000000C

This mask shows, in hex, the state of all 64 possible points (maximum rack of 16 modules with four points per module). The lowest points are on the right:

Hex:	0	0	0	0	0	0	0	0	0	0	0	0	0	0	0	C
Binary:	0000	0000	0000	0000	0000	0000	0000	0000	0000	0000	0000	0000	0000	0000	0000	1100
Points:	3-0	3-0	3-0	3-0	3-0	3-0	3-0	3-0	3-0	3-0	3-0	3-0	3-0	3-0	3-0	3-0
Modules:	15	14	13	12	11	10	9	8	7	6	5	4	3	2	1	0

In this case, all points are OFF except for points 2 and 3 on the module in position 0, which are ON. For more help in interpreting bank data, see [page 219](#).

Bank *counter* data, however, uses unsigned 32-bit integers; for help in interpreting counter data, see [page 219](#).

Analog Bank Window

Values are current as of the Status date and time.  
Click Refresh to update values.

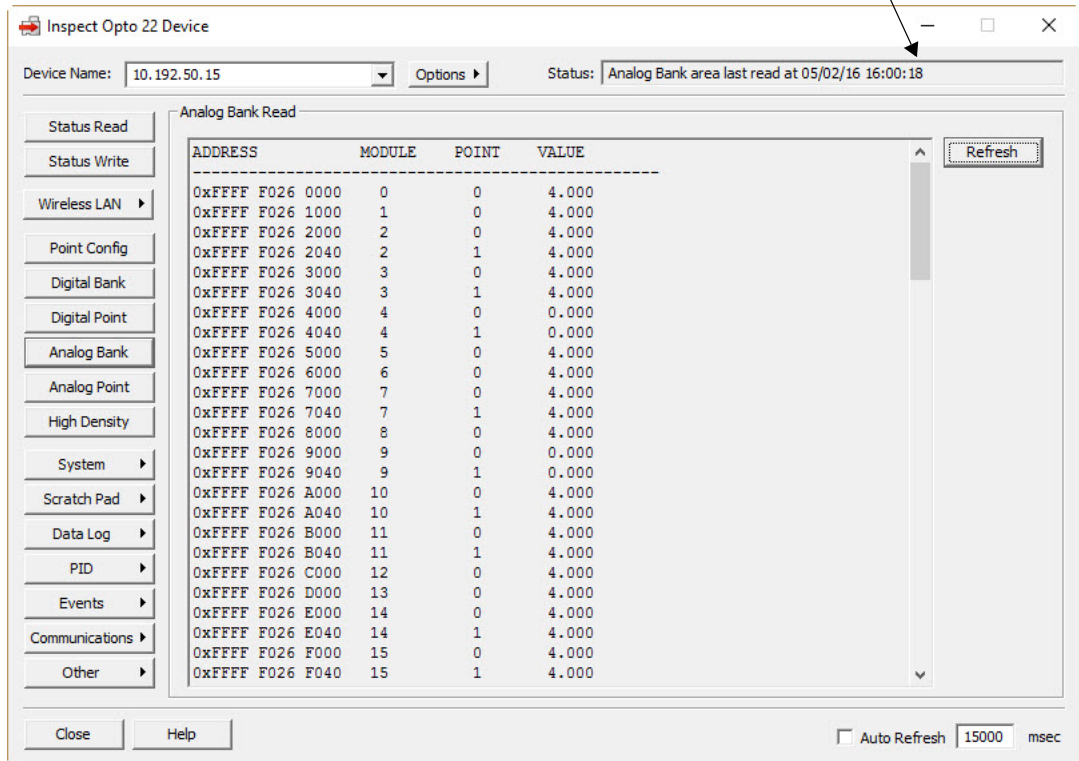

For help in interpreting analog point data, see “IEEE Float Data” on page 221.

PAC-R  
EB  
SB  
UIO  
EIO  
SIO

Reading and Writing to SNAP High-Density Digital Points

In PAC Manager, you can read or write to points on high-density digital modules in two ways: one at a time using the Digital Point button (see page 193), or all at once as shown below.

- To read or write to points on high-density digital modules, click the Inspect button  in the PAC Manager main window.

2. In the Inspect Opto 22 Device window, type the Device Name (or IP address) of the I/O unit (or choose it from the drop-down list). Click High Density.

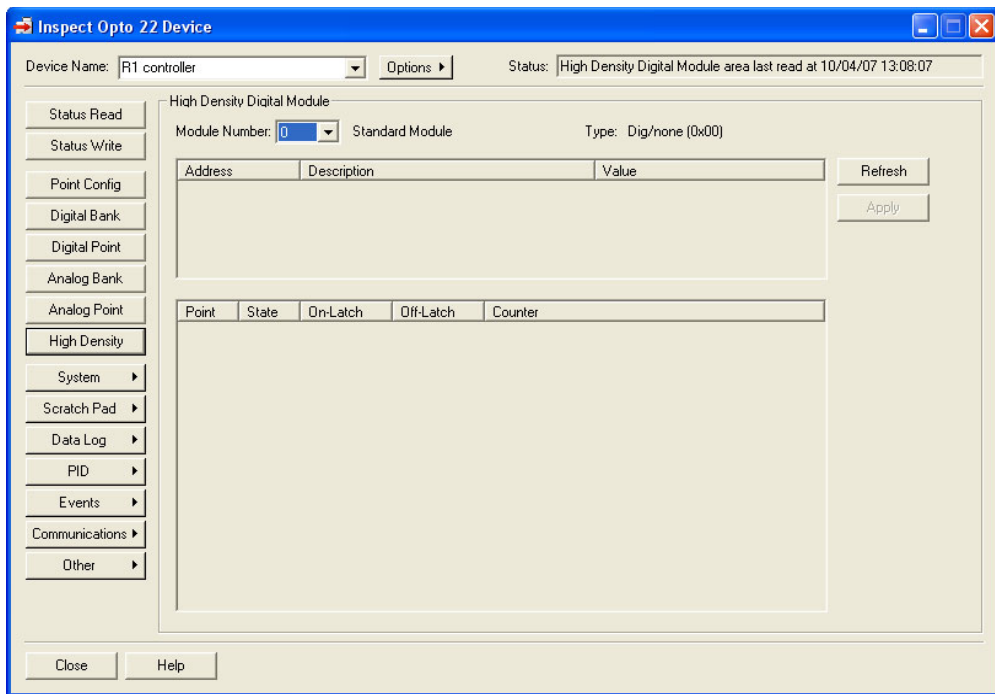

3. Click the module number for the point you want to read or write to.

### SNAP High-Density Digital Input

For an input module, the current states and latches appear, both as bitmasks in hex and individually for each point. Counter values appear in the Counter column.

The screenshot shows the 'Inspect Opto 22 Device' window. The 'Device Name' is 'R1 controller' and the 'Status' is 'High Density Digital Module area last read at 10/04/07 13:14:40'. The 'Module Number' is set to '12', and the 'Type' is 'IDC-32 (0xE0)'. The 'High Density Digital Module' section shows a table of addresses and values:

Address	Description	Value
0xFFFF F180 8300	STATUS	0x 00000000 00000000
0xFFFF F180 8308	Point State Mask	0x 00000000 00000000
0xFFFF F180 8310	LATCHES	0x 00000000 00000000
0xFFFF F180 8308	On-Latch Mask	0x 00000000 00000000
0xFFFF F180 8310	Off-Latch Mask	0x 00000000 00000000

Below this is a table of 16 points with their current states and latches:

Point	State	On-Latch	Off-Latch	Counter
0	Off	Off	On	0
1	Off	Off	On	0
2	Off	Off	Off	0
3	On	On	Off	8
4	On	On	Off	0
5	Off	Off	Off	0
6	Off	On	On	0
7	Off	Off	Off	0
8	Off	Off	Off	0
9	On	Off	Off	11
10	Off	Off	On	0
11	On	Off	Off	6
12	Off	Off	Off	0
13	Off	Off	Off	0
14	Off	Off	Off	0
15	Off	Off	Off	0
16	Off	Off	Off	0

Buttons for 'Status Read', 'Status Write', 'Point Config', 'Digital Bank', 'Digital Point', 'Analog Bank', 'Analog Point', 'High Density', 'System', 'Scratch Pad', 'Data Log', 'PID', 'Events', 'Communications', and 'Other' are visible on the left. Buttons for 'Refresh', 'Apply', 'Clear On-Latch', 'Clear Off-Latch', and 'Clear Counter' are on the right. 'Close' and 'Help' buttons are at the bottom.

To clear latches for a point, highlight the point number and click the Clear On-Latch or Clear Off-Latch button. To clear the counter for a point, highlight the point and click the Clear Counter button.

The change is immediately sent to the I/O unit, and the window is updated.

### SNAP High-Density Digital Output

For an output module, the current states appear, as bitmasks in hex and for each point.

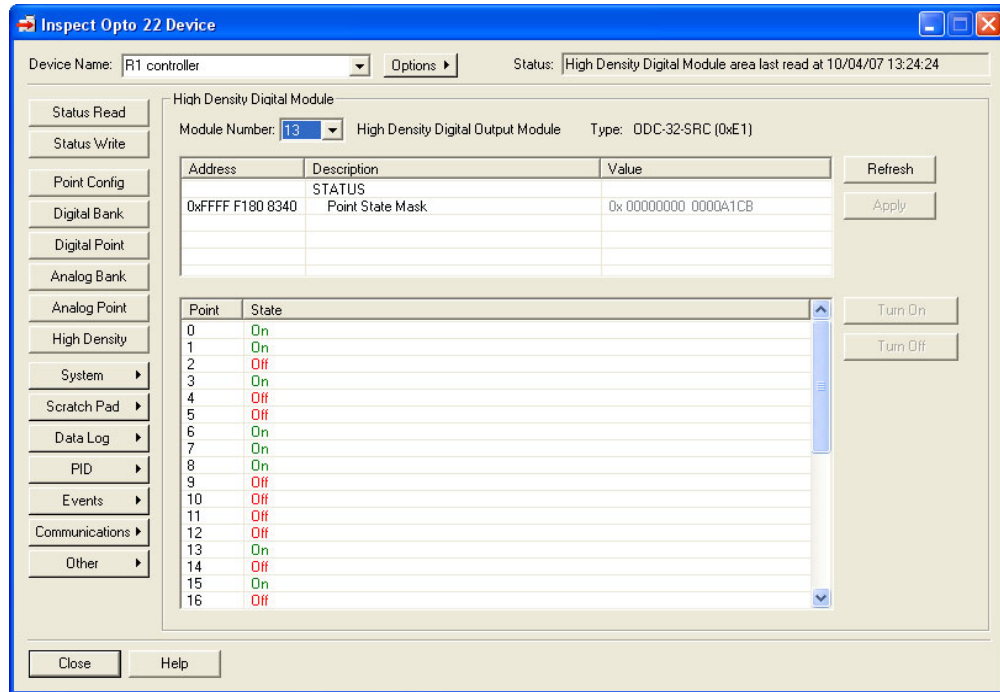

To turn a point on or off, highlight the point number and click the Turn On or Turn Off button.

The change is immediately sent to the I/O unit, and the window is updated.

PAC-S  
PAC-R  
SoftP  
EB  
UIO  
EIO

### Reading System Date and Time

SNAP PAC controllers and SNAP Ultimate and SNAP-ENET-RTC brains have a real-time clock. A SoftPAC controller uses the computer's clock.

1. To read the date and time on the device, click the Inspect button  in the PAC Manager main window.
2. In the Inspect window, type the name of the device (or choose it from the drop-down list). Click System > Date And Time.

The device's date and time appear.

*NOTE: Although you can change the date and time by clicking a cell in the Value column and typing in the new number, then clicking Apply, there is a slight delay before the time is set on the unit. Other ways of setting time may be more accurate, for example, using PAC Control to synchronize system date and time. See also "Setting Up System Date and Time" on page 132 for another method.*

PAC-S  
PAC-R  
SoftP  
EB  
SB  
UIO  
EIO

### Reading and Writing to the Scratch Pad Area

Before using this section, be sure to read "Event/Reaction Concepts" on page 145. Remember that support for these areas varies by processor:

	PAC-R	PAC-S	SoftP	EB1	EB2	SB1	SB2	UIO	EIO	SIO
Scratch Pad Bits:	Yes	Yes	Yes	Yes	Yes	Yes	Yes	Yes	Yes	No



	PAC-R	PAC-S	SoftP	EB1	EB2	SB1	SB2	UIO	EIO	SIO
Scratch Pad Integer 32s, Strings, Floats:	Yes	Yes	Yes	Yes	Yes	Yes	Yes	Yes	No	No
Scratch Pad Integer 64s:	Yes	Yes	Yes	Yes	Yes	Yes	Yes	No	No	No

You can read the current state of Scratch Pad bits and current values in Scratch Pad integers, strings, and floats using PAC Manager. You can also change these values in real time, which can be useful for testing. **If you are running PAC Control, make sure your changes do not conflict with strategy logic.**

1. To read or change the Scratch Pad area, click the Inspect button  in the PAC Manager main window.
2. In the Inspect Opto 22 Device window, type the IP address of the I/O unit (or choose it from the drop-down list). Click Scratch Pad and then choose the area you want from the pop-up menu.

PAC-S  
PAC-R  
SoftP  
EB  
SB  
UIO  
EIO

### Scratch Pad Bits

The Scratch Pad bits window shows you the current state of the Scratch Pad bits (as of the Status date and time) and the current On and Off masks. You can change any of these masks by clicking its cell in the Value column and typing in the new mask, then clicking Apply.

Values are current as of the Status date and time.  
Click Refresh to update values.

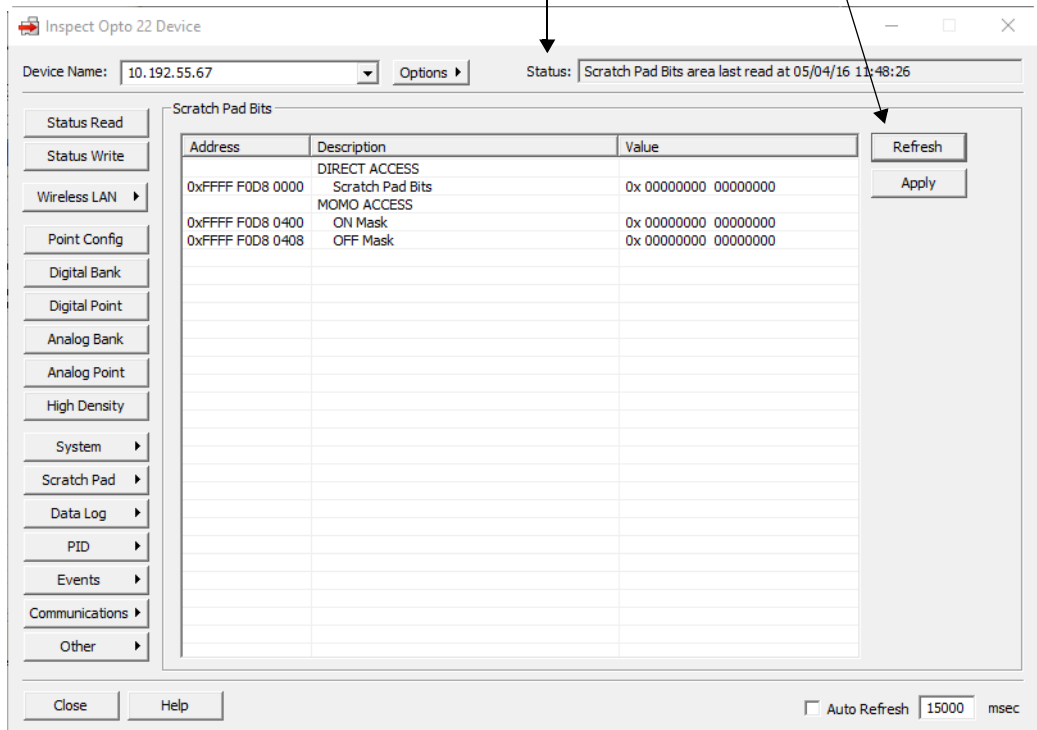

PAC-S  
PAC-R  
SoftP  
EB  
SB  
UIO

Scratch Pad Integers, Floats, and Strings

Scratch Pad Floats are used as the example here, but integers and strings are similar. Current values are shown as of the Status date and time. To update values, click Refresh.

Change the value in the Value column.

When all new values are entered, click Apply.

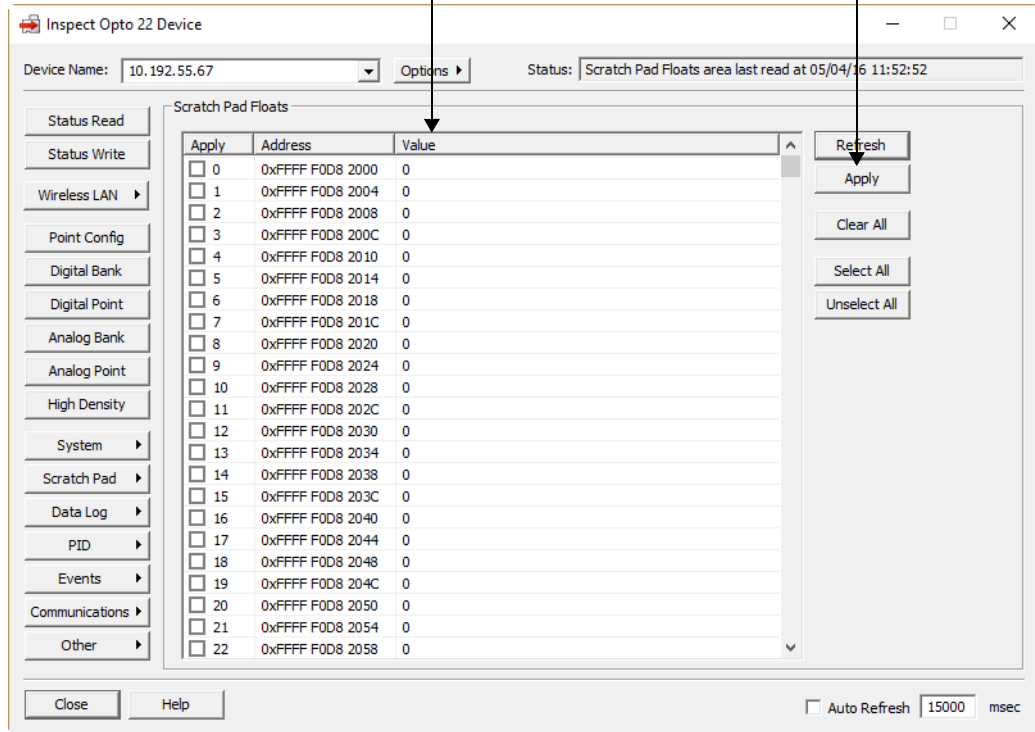

The Select All and Unselect All buttons control the check marks in the Apply column boxes. The Clear All button puts all values at zero.

1. To change a value in Scratch Pad integers, floats, or strings, click the cell in the Value column and type the new value.  
A check mark appears in the Apply column box. If you do not want to send a value, click the box to uncheck it.
2. Click the Apply button to write the new values to the Scratch Pad.  
All the checked items are changed.

PAC-R  
EB  
SB  
UIO  
EIO

## Data Logging

Data logging is normally configured in a configuration file (see [page 103](#)), but you can change it in the Inspect window. Remember that changes made here cannot be saved to a configuration file, however. To change configuration, with the I/O unit's IP address in the Inspect window, click Data Log > Data Logging Configure. For help, see the information in the steps on [page 103](#).

To read the data in a data log you have set up, use PAC Manager's Inspect window. See instructions on [page 105](#). To clear all data from a data log, see [page 106](#).

PAC-R  
EB  
SB  
UIO  
EIO

## Reading or Changing PID Loops

For information about PID loops, see [page 78](#). PIDs are normally configured in a configuration file following the steps on [page 80](#). However, you can also configure, view, or change them using PAC Manager's Inspect window. (Remember that changes made here cannot be saved to a configuration file.)

1. In the PAC Manager main window, click the Inspect button .

The Inspect window opens.

- If you haven't used the Inspect window before, no data is displayed in the Status Read pane.
- If you *have* used the Inspect window before, the last device you inspected is shown in the Device Name field, and current Status Read information appears in the window.
- If you have configured other devices, they are listed in alphabetical order in the drop-down list.

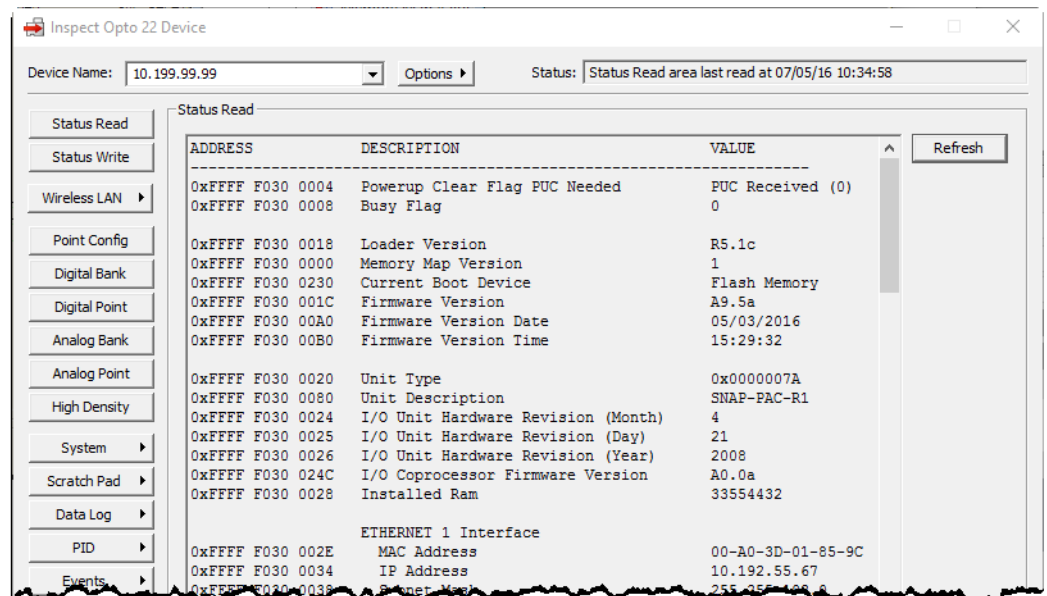

- If you have configured six or more devices, the Inspect window provides two additional time-saving features: Next and Back navigation buttons (to navigate back and forth through the alphabetized list

of devices), and a list of the five most recently inspected devices (displayed at the top of the drop-down list).

Next and Back navigation buttons and Most Recently Used list are displayed when you have six or more devices configured.

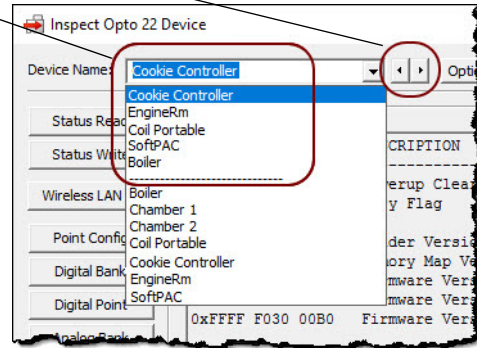

2. In the Device Name field, type the name (or IP address) of the I/O unit (or choose it from the drop-down list). Click PID and choose PID Loops from the submenu.

Information for this PID loop is shown in the window.

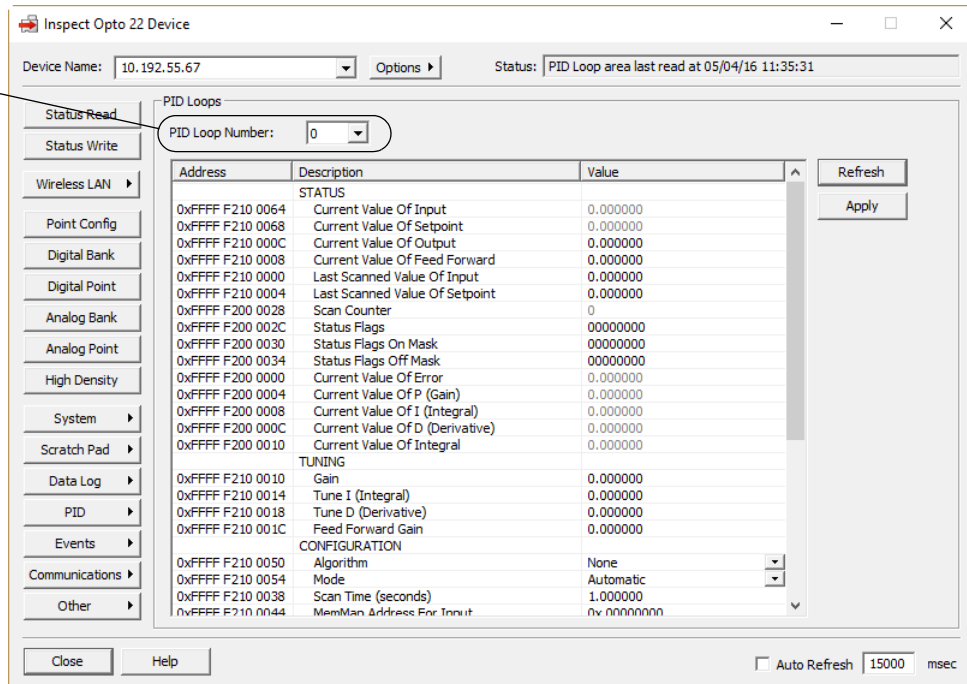

3. From the drop-down list, choose the PID loop number you want to configure, view, or change. Existing PID loops are indicated by an asterisk (\*) next to the number.
4. To configure or change the PID, click inside the cell in the Value column and type the new value or choose it from a drop-down list, if one is available. When you have finished making changes, click Apply to send them to the I/O unit.

*NOTE: If you are using PAC Control, it is easiest to tune PID loops in your PAC Control strategy running in Debug mode. For details, see the [PAC Control User's Guide](#) (form 1700).*

For information on memory map addresses and what they contain, see the *OptoMMP Protocol Guide* (form 1465).

PAC-R  
EB  
UIO  
EIO

### Reading or Changing PID Module Settings

PID module settings are normally configured in a configuration file (see page 67), although you can also change them in the Inspect window.

To read or change settings on a PID module, with the I/O unit's IP address in the PAC Manager Inspect window, click PID > Module. For help in making changes, see the instructions on page 67.

PAC-R  
EB  
SB  
UIO  
EIO

### Reading or Changing Events and Event Messages

Digital, alarm, serial, timer, and Wiegand events are normally configured in a configuration file. Event messages are configured in a configuration file if you are using PAC Control; otherwise, they are configured in the Inspect window. See [Chapter 4: Setting Up Events and Reactions](#) for configuration steps on all events and event messages.

However, you can read current events and also change their configuration in the Inspect window. Digital Events are shown below as an example.

Choose the event number from the drop-down list.

This event's configuration data is shown here.

Current status of the event (as of the Status date and time) is shown here.

Address	Description	Value
EVENT		
0xFFFF F0D4 004C	Event Enable/Disable	Enabled
0xFFFF F0D4 0044	Use which digital data for trigger?	Digital Point State
0xFFFF F0D4 0000	Digital ON	0x 00000000 00000000
0xFFFF F0D4 0008	Digital OFF	0x 00000000 00000000
0xFFFF F0D4 0044	Use which scratch pad data for trigger?	Scratch Pad Bits
0xFFFF F0D4 0010	Scratch Pad ON	0x 00000000 00000000
0xFFFF F0D4 0018	Scratch Pad OFF	0x 00000000 00000000
0xFFFF F0D4 0040	Length of Delay Before Reaction (msec.)	0
REACTION		
0xFFFF F0D4 0044	Reaction Occurs	Continuously
0xFFFF F0D4 0044	Use which digital data for reaction?	Digital Point State
0xFFFF F0D4 0020	Digital ON	0x 00000000 00000000
0xFFFF F0D4 0028	Digital OFF	0x 00000000 00000000
0xFFFF F0D4 0044	Use which scratch pad data for reaction?	Scratch Pad Bits
0xFFFF F0D4 0030	Scratch Pad ON	0x 00000000 00000000
0xFFFF F0D4 0038	Scratch Pad OFF	0x 00000000 00000000
CURRENT STATUS		
0xFFFF F0D4 004C	Event State	Off
0xFFFF F0D4 0048	Time Remaining (msec.)	0
0xFFFF F040 0000	Current Value - Digital Point State	0x 00000000 00000000
0xFFFF F0D8 0000	Current Value - Scratch Pad Bits	0x 00000000 00000000

## Reading or Changing Communications and Other Data

Other data on the I/O unit or standalone controller can also be read and changed using PAC Manager’s Inspect window. The following table shows where to find the data in the Inspect window and references page numbers in this guide for information to help you understand what you are reading or how to change it:

To read or change	Click this in the Inspect window	For help, see
Security	Communications > Network Security	<a href="#">page 94</a>
PPP	Communications > PPP	<a href="#">page 139</a>
Streaming	Communications > Streaming	<a href="#">page 120</a>
Email	Communications > E-mail	<a href="#">page 116</a>
Modbus	Communications > Modbus	<a href="#">page 128</a>
SNMP Agent	Communications > SNMP	<a href="#">page 112</a>
Serial ports on brain or controller	Communications > Communication Port Control	<a href="#">page 134</a>

In addition, you can read or write to any memory map address by clicking Other > Generic Read/Write. See the memory map appendix in the [OptoMMP Protocol Guide](#) (form 1465) to make certain you have the correct address before making any changes.

## WRITING COMMANDS TO THE DEVICE

*NOTE: If you are using the PAC Control Redundancy Kit and redundant controllers, do not use PAC Manager to work with your controllers. Instead, use the PAC Redundancy Manager that comes with PAC Control Professional (version R9.0 or higher).*

### Using OptoMMP Device Commands

*CAUTION: These hardware commands directly affect the operation or configuration of the device. Be careful when you use them, as they cannot be undone.*

PAC-S  
PAC-R  
SoftP  
EB  
SB  
UIO  
EIO  
SIO  
E1  
E2

#### Saving Configuration to a Device’s Flash Memory

Saving configuration data to the controller or I/O unit’s flash memory makes sure that the data is not lost when power to the device is turned off.

If you are using a configuration file (as in most of Chapters 2, 3, and 4), you can choose to save configuration data to flash memory when the file is loaded to the I/O unit. However, if you are writing configuration directly to the device (as in this chapter), you’ll need to follow these steps to save to flash.

Note that this command saves to flash the things you can configure in PAC Manager. It does not affect a PAC Control strategy, which is saved to flash via PAC Control or PAC Terminal.

**CAUTION:** *If you are using PAC Manager R9.0a or higher, PAC firmware R9.0a or higher, and loader version 6.0 or higher, and if a controller has a microSD card installed and the card already contains configuration data, that data will be overwritten. See the controller user’s guide for complete information about microSD.*

1. In the PAC Manager main window, click the Inspect button .
2. In the Device Name field, type the name (or IP address) of the device, or choose it from the drop-down list. Click Status Write.

- In the Operation Command list, highlight Store configuration to flash.

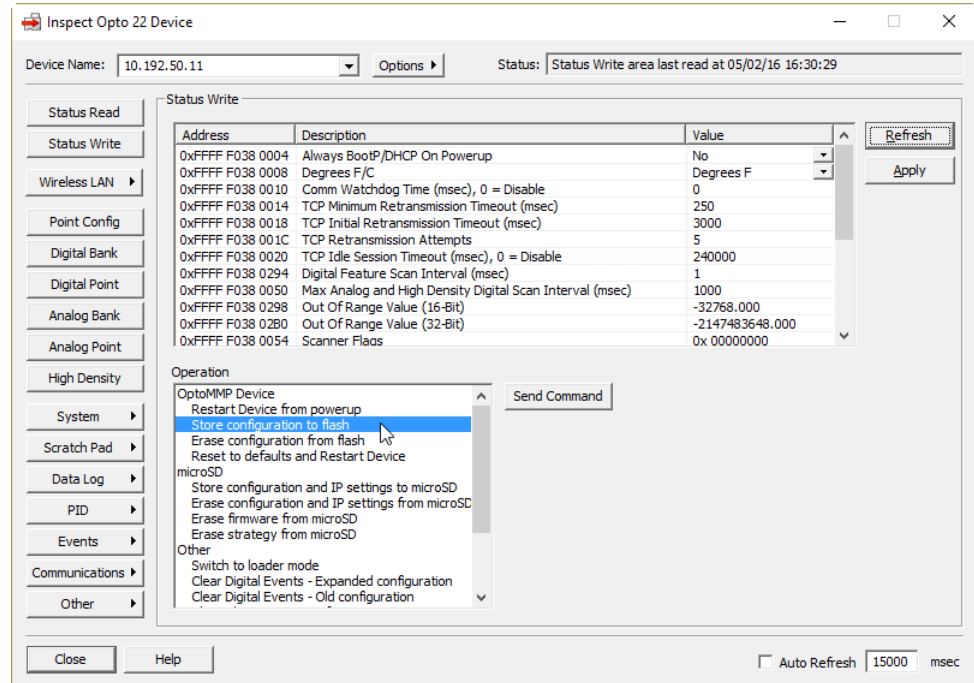

- Click Send Command.

The configuration data is stored to flash memory and a Success message appears.

PAC-S  
PAC-R  
SoftP  
EB  
UIO  
EIO  
SIO  
E1  
E2

### Restarting the Device

Restarting the device is just like turning the power off and then turning it back on again. This command can be used for both I/O units and controllers. For an I/O unit, if configuration data has not been saved to flash memory, restarting resets points to their defaults.

For some configurations to take effect, the device must be restarted. A SNAP PAC controller must be restarted after you configure its secondary IP address, for example. For an I/O unit, if you are using a configuration file (as in most of Chapters 2, 3, and 4), you can choose to restart the unit when the file is loaded to the I/O unit and saved to flash memory. However, if you are writing configuration directly to the I/O unit (as in this chapter), after you store to flash, you need to follow these steps to restart it.

- In the PAC Manager main window, click the Inspect button .
- In the Device Name field, type the name (or IP address) of the device, or choose it from the drop-down list. Click Status Write.

- In the Operation Command list, highlight Restart Device from powerup.

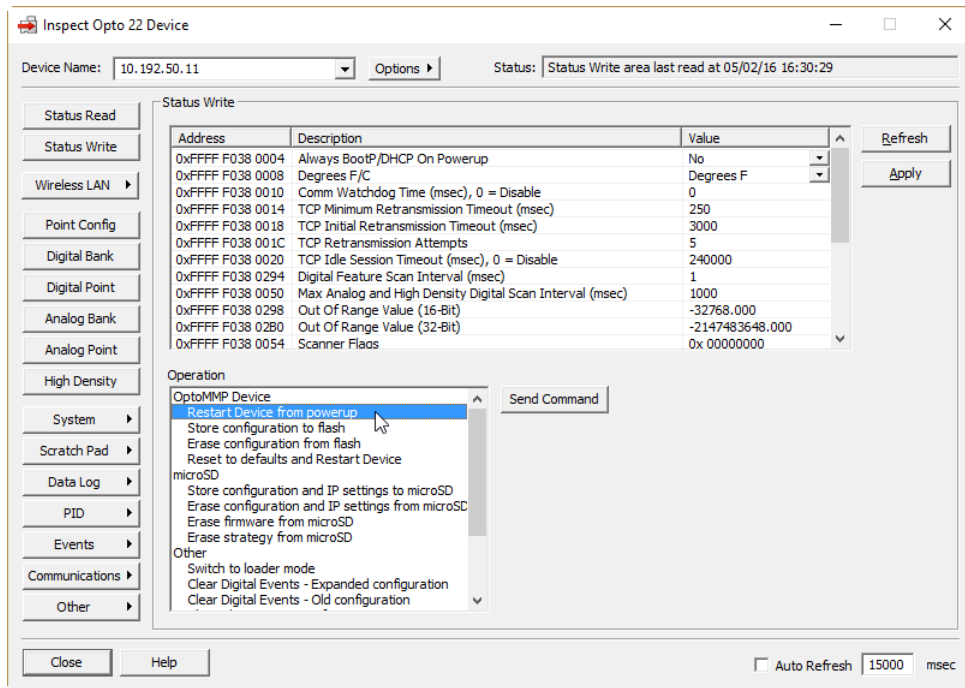

- Click Send Command.  
The device is restarted and a Success message appears.

PAC-S  
PAC-R  
SoftP  
EB  
SB  
UIO  
EIO  
SIO  
E1  
E2

### Resetting to Defaults and Restarting

Resetting the device to defaults erases configuration information from the device's flash memory. (It does not erase IP address settings nor PAC Control strategy files in a controller.) Resetting also does the following:

- If the device has PAC firmware R9.0a or higher *and* loader R6.0 or higher *and* a **microSD card** is present, resetting **erases** PAC firmware, strategy, and IP address and configuration data from the card (does not erase other data files or I/O coprocessor firmware)
- Clears all point configuration and features, such as offsets and gains, custom scaling, latches, counters, and minimum/maximum data
- Turns off digital outputs and defaults all digital points to inputs
- Sets analog outputs to zero scale (0 counts)
- Restarts the device

Follow these steps to reset and restart the device:

- In the PAC Manager main window, click the Inspect button .
- In the Device Name field, type the name (or IP address) of the I/O unit, or choose it from the drop-down list. Click Status Write.



- In the Operation Command list, highlight Reset to defaults and Restart Device.

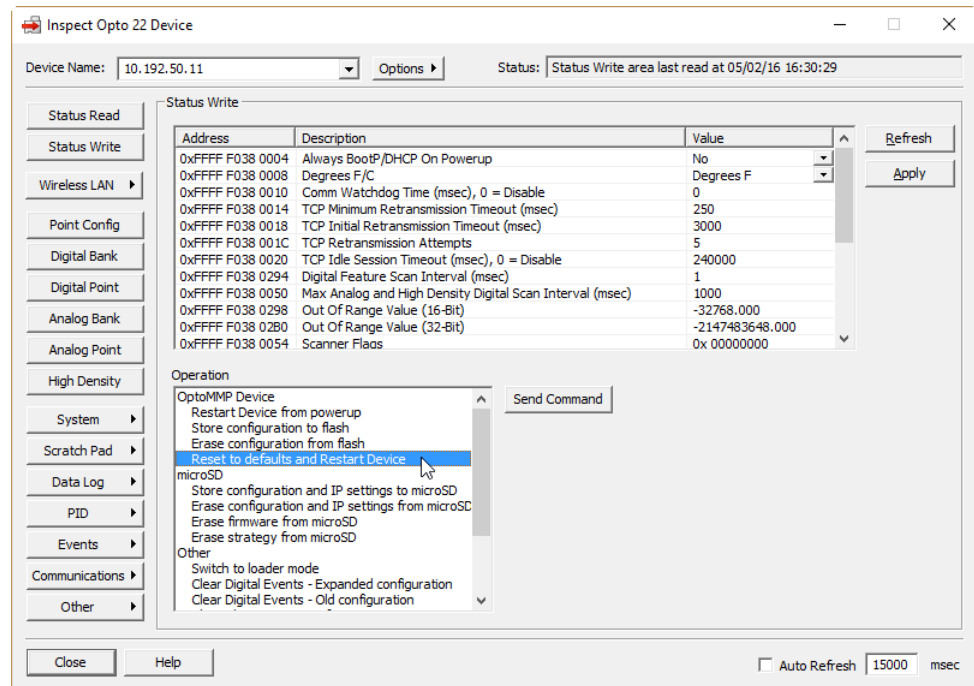

- Click Send Command.  
The I/O unit is set to defaults and restarted. A Success message appears.

PAC-S  
PAC-R  
EB  
SB  
UIO  
EIO  
SIO  
E1  
E2

#### Sending a Powerup Clear

The powerup clear command clears a flag that indicates the I/O unit has lost and then regained power. Normally a powerup clear command is automatically sent, so normally you won't need to use this command. If you receive a powerup clear error message, however, you can use PAC Manager to send the command. Note that a power loss means that any configuration data not stored to the I/O unit's flash memory has been lost.

- In the PAC Manager main window, click the Inspect button .
- In the Device Name field, type the name (or IP address) of the device. Click Status Write.
- In the Operation Command list, highlight Send powerup clear.
- Click Send Command.

The powerup clear is sent, and a Success message appears.

PAC-S  
PAC-R

#### Using microSD Commands

*NOTE: These commands require PAC Manager R9.0a or higher and PAC firmware R9.0a or higher. Use Status Read to see the firmware version (see "Reading Basic Device Information" on page 165).*

SNAP PAC S-series and R-series controllers manufactured from November 2008 to the present have a microSD card slot that accommodates cards up to 2 GB. These cards can be used to log data, of course, but they can also be used as a kind of boot disk for the controller, so that you can replace a failed controller with a new one by simply putting the prepared microSD card into the new controller, turning the controller on, and connecting it to the network. The new controller boots from the card and configures itself; you can then use the controller's Reset button to save the data on the card to flash memory.

Before using the card or any of these commands, be sure to read the section on microSD in the Maintenance chapter of the controller user’s guide. A few steps are repeated here for convenience, but the user’s guide has the complete information.

Three types of information can be put on the card to use it as a boot disk:

- PAC firmware files
- Strategy files
- Configuration data

Configuration data includes all current configurations (those that can be done in PAC Manager) plus the controller’s IP address and IP settings. The steps below show only how to add configuration data; see the controller user’s guide to add firmware and strategy files.

**Putting Configuration Data on the microSD Card**

1. In the PAC Manager main window, click the Inspect button .
2. In the Device Name field, type the name (or IP address) of the device, or choose it from the drop-down list. Click Status Write.
3. In the Operation Command list, highlight Store configuration and IP settings to microSD card.

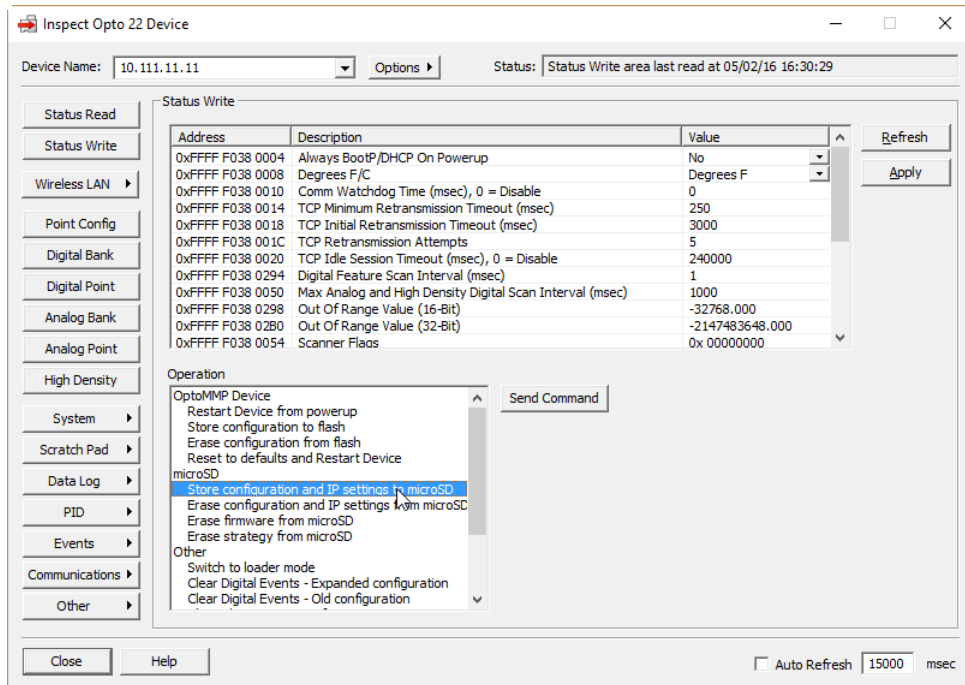

4. Click Send Command.  
The controller’s IP settings and all current configuration data are saved to the card.

After you have replaced a controller with a new one by using the microSD card as a boot disk, you must save the data from the card to the controller’s flash memory, so it will be available in case the microSD card is removed. Cycling power does not do this. Instead, follow the steps in the Maintenance chapter (microSD section) of your controller’s user’s guide.

## Using Other microSD Card Commands

You can also use the following commands with a microSD card in the controller. These commands require PAC Manager R9.0a or higher and PAC firmware R9.0a or higher. Read microSD card information in the controller user's guide before using the card.

- In the Inspect window, type the device's name or IP in the Device Name field, click Status Write, and choose the command you need in the Operation Command list:
  - Erase Configuration from microSD—deletes all configuration and IP address data from the card. Does not delete other data files, firmware, or strategy files on the card.
  - Erase Firmware from microSD—deletes firmware on the card, wherever it is located; also deletes firmware command and response files. Does not delete data files or strategy files.
  - Erase Strategy from microSD—deletes only the strategy from the card. Does not delete data files, IP address and configuration data, or firmware files.
- Click Send Command.

PAC-R  
EB  
UIO  
EIO  
SIO  
E1  
E2

## Clearing Configurations and Data Samples

You can use PAC Manager to clear the following configurations: digital events (both old and expanded), alarm events, email, PID loops, and PPP. You can also clear data in the data log. (Note that some of these features do not apply to some devices. See the comparison chart on [page 9](#).)

- In the PAC Manager main window, click the Inspect button .
- In the Device Name field, type the name (or IP address) of the I/O unit. Click Status Write. In the Operation Command list, scroll down to see commands listed under Other.

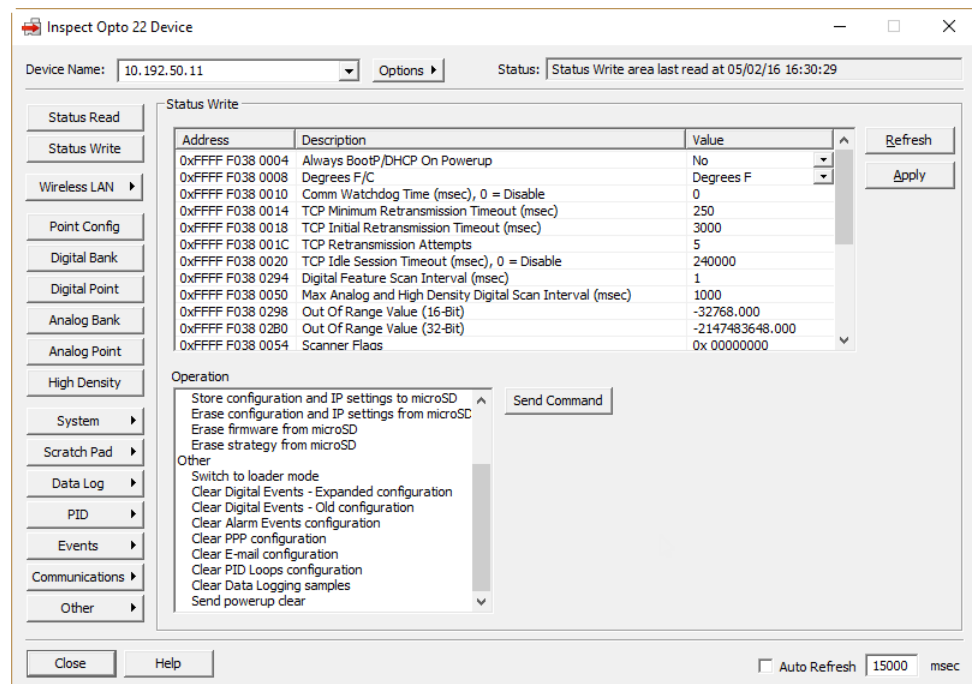

- Click the command you want:
  - Clear "Digital Events - Expanded" configuration (Clears digital events in PAC firmware 8.1 and higher. For PAC firmware 8.0 and older, clears Timers configuration.)
  - Clear "Digital Events - Old" configuration (Clears digital events in PAC firmware 8.0 and older.)
  - Clear Alarm Events configuration

- Clear PPP configuration
  - Clear E-mail configuration
  - Clear PID Loops configuration
  - Clear Data Logging Samples
4. With the command you want highlighted, click Send Command.  
The command is sent immediately to the I/O unit, and you see a Success message.

## FORMATTING AND INTERPRETING DATA

PAC-S  
PAC-R  
SoftP  
EB  
UIO  
EIO  
SIO  
E1  
E2

Data is formatted differently for different addresses in the device’s memory map. Starting memory map addresses are shown in PAC Manager; for a complete list of memory map addresses, see the [OptoMMP Protocol Guide](#) (form 1465).

This section shows how to format and interpret various types of data when you are reading or writing to a memory-mapped device.

### Mask Data

Some data is in the form of a 32-bit or 64-bit mask—four or eight addresses, each holding eight bits. Each bit in the mask contains the data for one thing in a group: one channel, one module, one Scratch Pad bit, etc.

#### Mask Data for *groov* and SNAP I/O units

For example, most high-density digital module data (for both *groov* and SNAP) and most SNAP digital bank data is in this form (*groov* I/O units and *groov* RIO modules do not support banks). For example, to read the state of SNAP digital channels in a bank, you would read the eight bytes starting at FFFF0400000.

Here’s how the data would be returned:

At address:	FFFF0400000								→	FFFF0400007							
These bit numbers:	7	6	5	4	3	2	1	0	→	7	6	5	4	3	2	1	0
Show data for these points:	3	2	1	0	3	2	1	0	→	3	2	1	0	3	2	1	0
On SNAP modules in these positions in the rack:	15				14				→	1				0			

Therefore, at address FFFF0400000:

This hex data:	B				1			
Equals this binary data:	1	0	1	1	0	0	0	1
Showing the states:	On	Off	On	On	Off	Off	Off	On
Of these channels:	3	2	1	0	3	2	1	0
On these modules:	15				14			

Data from other addresses marked as masks is formatted in a similar way.

Mask Data for E1s

The bank area of the memory map is based on a four-channel SNAP module. For I/O units with E1 brain boards, each channel is treated as the first channel on a SNAP module. That means that when you read a bank of digital channels on an E1, data appears only in the first of every four channels, like this:

At address:	FFFFF0400000								→	FFFFF0400007							
These bit numbers:	7	6	5	4	3	2	1	0	→	7	6	5	4	3	2	1	0
Show data for these points:	--	--	--	0	--	--	--	0	→	--	--	--	0	--	--	--	0
On G1 or G4 modules in these positions in the rack:	15				14				→	1				0			

So, at address FFFF04000000:

This hex data:	1				0			
Equals this binary data:	0	0	0	1	0	0	0	0
Showing the states:	--	--	--	On	--	--	--	Off
Of these channels:	--	--	--	0	--	--	--	0
On these modules:				1				0

These memory map addresses apply not only to G1 and G4 modules, but also to integral racks and even to Quad Pak modules. Channels on all E1 I/O units are treated the same way, no matter how they are physically placed on the rack.

Unsigned 32-bit Integer Data

Much of the data in the memory map is in the form of unsigned integers, either one byte, two bytes, or four bytes. With multiple bytes, since the memory-mapped devices use a Big Endian architecture, the high order byte is in the low order address.

For example, SNAP digital bank counter data is in 4-byte unsigned integers. It takes four bytes to contain the data for one channel. To read digital bank counter data for channel 0 on module 0, you would start with address FFFF0400100. The following table shows the pattern of bank counter data for the first few channels on a SNAP rack:

Bytes at these addresses:	FFFF0400100	FFFF0400101	FFFF0400102	FFFF0400103	FFFF0400104	FFFF0400105	FFFF0400106	FFFF0400107	FFFF0400108	FFFF0400109	FFFF040010A	FFFF040010B	FFFF040010C	FFFF040010D	FFFF040010E	FFFF040010F	FFFF0400110	FFFF0400111	FFFF0400112	FFFF0400113	FFFF0400114	FFFF0400115	FFFF0400116	FFFF0400117	→
Show data for this point:	0				1				2				3				0				1				→
On the module in this position on the rack:	0												1												→

The most significant byte is at the lowest address. For module 0, channel 0, for example, you might receive the following data:

At this address	This binary data	Equals this hex data	16	BB	18	87
FFFF F040 0100	0001 0110	16	↑			
FFFF F040 0101	1011 1011	BB		↑		
FFFF F040 0102	0001 1000	18			↑	
FFFF F040 0103	1000 0111	87				↑

The 32-bit integer for this reading would be **16 BB 18 87** (most significant byte at lowest address). This hex figure correlates to the decimal value 381,360,263.

Remember that if you are processing this data using a Little Endian computer (such as an Intel-based PC), you must convert the data from the Big Endian format in order to use it. Little Endian format is the opposite of Big Endian; Little Endian places the most significant byte at the highest address.

### Digital Channel Data (4-Channel Modules)

*NOTE: For high-density digital modules, see "Mask Data" on page 218.*

(Does not apply to *groov* I/O or *groov* RIO modules, which have more than 4 channels.) For consistency in starting addresses, data for individual digital channels has a length of four bytes. However, only the least significant bit contains the data you're looking for.

For example, to read the state of channel 0 on module 0, you would start with address FFFFF0800000. Data would be returned as follows:

To read this information:	Point 0 on Module 0: Point State							
Use these addresses:	FFFFF0800000	FFFFF0800001	FFFFF0800002	FFFFF0800003				
These bits:	7 6 5 4 3 2 1 0	7 6 5 4 3 2 1 0	7 6 5 4 3 2 1 0	7 6 5 4 3 2 1 0				
Contain this data (binary):	0 0 0 0 0 0 0 0	0 0 0 0 0 0 0 0	0 0 0 0 0 0 0 0	0 0 0 0 0 0 0 1				
(hex):	0	0	0	0	0	0	0	1
	Ignore these							Point state is ON.

Digital Channel Data for E1s

If you are using I/O units with E1 brain boards, remember that the memory map is based on a four-channel SNAP module. For an E1, channel data appears in the addresses that correspond to the first of each group of four channels in the memory map, like this:

Addresses for point state:	FFFF0800F00	FFFF0800E00	FFFF0800D00	FFFF0800C00	FFFF0800B00	FFFF0800A00	FFFF0800900	FFFF0800800	FFFF0800700	FFFF0800600	FFFF0800500	FFFF0800400	FFFF0800300	FFFF0800200	FFFF0800100	FFFF0800000
E1 module position:	15	14	13	12	11	10	9	8	7	6	5	4	3	2	1	0
Point number:	0	0	0	0	0	0	0	0	0	0	0	0	0	0	0	0

Channel data appears this way for all module types used with an E1: G1, G4, Quad Pak, and integral racks.

IEEE Float Data

For individual analog channels, values, counts, and minimum and maximum values for one channel are located next to each other in the memory map. All are four bytes and are IEEE 754 floats.

For example, individual analog channel data for channels 0 and 1 on module 0 appears in these addresses:

Module	Channel	Data	Beginning Address	Ending Address
0	0	Scaled units (E.U.*)	FFFF F026 0000	FFFF F026 0003
		Counts	FFFF F026 0004	FFFF F026 0007
		Minimum value (E.U.*)	FFFF F026 0008	FFFF F026 000B
		Maximum value (E.U.*)	FFFF F026 000C	FFFF F026 000F
	1	Scaled units (E.U.*)	FFFF F026 0040	FFFF F026 0043
		Counts	FFFF F026 0044	FFFF F026 0047
		Minimum value (E.U.*)	FFFF F026 0048	FFFF F026 004B
		Maximum value (E.U.*)	FFFF F026 004C	FFFF F026 004F

\* Engineering Units

IEEE 754 float format is as follows:

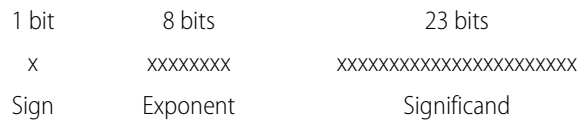

Float calculation:  $(-1)^{\text{Sign}} \times [1 + \text{Significand}/2^{23}] \times 2^{(\text{Exponent}-127)}$

**Example for Opto 22 memory map**

At this address:	base address	base address + 1	base address + 2	base address + 3
This hex data:	41	77	33	33
In binary:	0 100 0001	0 111 0111	0011 0011	0011 0011
In these bits:	31	30 . . . 23	22 . . . 0	
Equals (in decimal):	0	130	7,811,891	
Representing:	Sign	Exponent	Significand	

$$\begin{aligned}
 \text{Decimal} &= (-1)^0 \times [1 + 7,811,891/2^{23}] \times 2^{(130-127)} \\
 &= 1 \times [1.931] \times 8 \\
 &= 15.45 \text{ (rounded to 2 decimal places)}
 \end{aligned}$$

For more information on floats and issues that may arise in their use, see the [Using Floats Technical Note](#) (form 1755) available on our website, [www.opto22.com](http://www.opto22.com).

**Analog Bank Data**

(Does not apply to *groov* I/O units or *groov* RIO modules.) Remember that the bank area of the memory map is set up for four channels per module. Analog modules with more than four channels (points) will show data for channels 0–3 only. If the analog modules you are using have only one or two channels, the addresses for the upper two or three channels in each module will contain the following: for output modules, 0; for input modules, FFFFFFFF.

For example, to read all bank analog channel values in scaled units, you would read 256 bytes starting at address FFFF0600000. Here’s how data for two-channel input modules in positions 0 and 1 would appear:

Beginning Address	Ending Address	Data Format	Module	Channel
FFFF F060 0000	FFFF F060 0003	four bytes—IEEE float	0	0
FFFF F060 0004	FFFF F060 0007	four bytes—IEEE float		1
FFFF F060 0008	FFFF F060 000B	FFFFFFFF		2
FFFF F060 000C	FFFF F060 000F	FFFFFFFF		3
FFFF F060 0010	FFFF F060 0013	four bytes—IEEE float	1	0
FFFF F060 0014	FFFF F060 0017	four bytes—IEEE float		1
FFFF F060 0018	FFFF F060 001B	FFFFFFFF		2
FFFF F060 001C	FFFF F060 001F	FFFFFFFF		3

On an I/O unit with an E2 brain board, all modules have only one channel, so the upper three channels would contain 0 (outputs) or FFFFFFFF (inputs).



# 6: Maintaining Devices

## INTRODUCTION

This chapter includes step-by-step procedures for maintaining controllers and brains, including:

- Viewing and changing IP addresses (below).
- Loading new firmware ([page 225](#)).  
To find out the current brain firmware version, see [“Getting Device and Firmware Information—Individual Device” on page 248.](#)
- Maintaining files ([page 239](#)).

For other maintenance tasks, such as resetting the device to factory defaults or handling a device whose IP address you don't know, see the controller or brain user's guide.

## CHANGING IP ADDRESSES

If you need to change an IP address or subnet mask on an Ethernet-based device, you can do so using PAC Manager. You must know the current IP address in order to change it. The white sticker on the device may show the IP address. If not, see the device's user guide for instructions.

PAC-S  
PAC-R  
EB  
UIO  
EIO  
SIO  
E1  
E2

### Controllers, Brain Boards, and Brains with Firmware R5.0 or Higher

Use the steps in this section to change an IP address on:

- SNAP PAC controllers and brains
  - E1 and E2 brain boards
  - SNAP Simple I/O brains
  - SNAP Ultimate and SNAP Ethernet brains with firmware version R5.0 or higher  
(For SNAP Ultimate and SNAP Ethernet brains with lower firmware, see the [SNAP Ethernet-Based I/O Units User's Guide](#), form 1460)
1. If PAC Manager isn't already open it, start it. (For instructions, see the footnote on [page 16](#).)

- In the menu bar, click Tools > Change IP Settings.

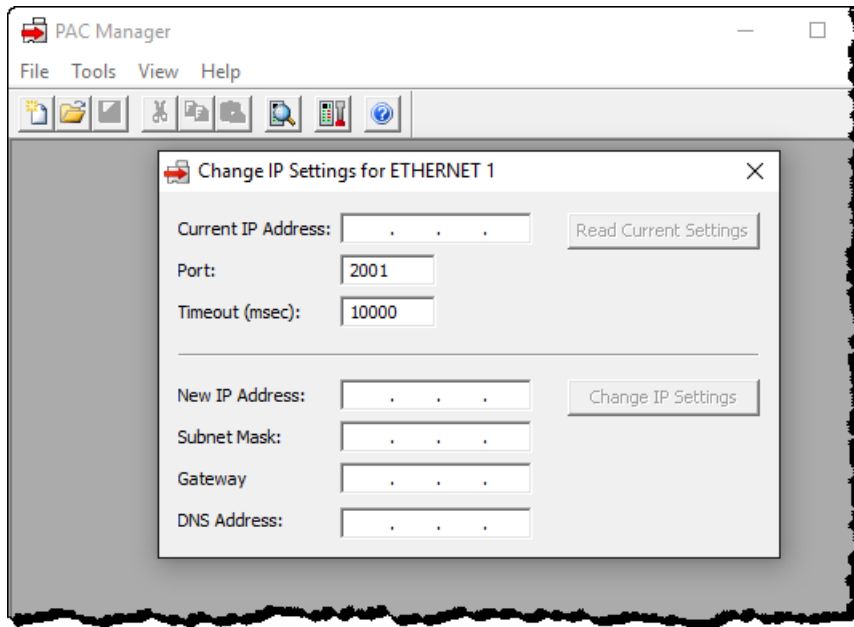

- In the Current IP Address field, type the IP address of the device whose address you want to view or change. Click Read Current Settings to see the current subnet mask, gateway address, and DNS address.

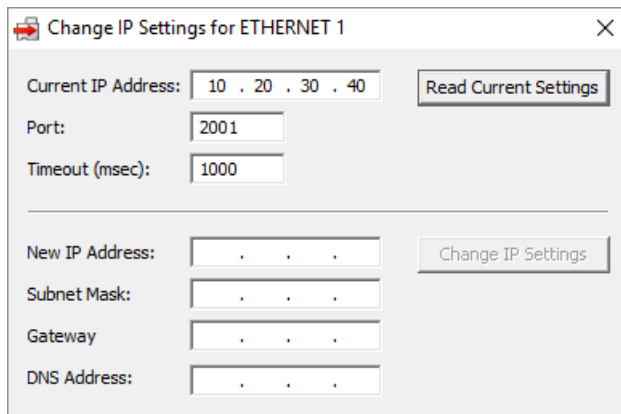

- To change the IP address, subnet mask, or other addresses, enter the new numbers. Make sure you have typed everything correctly. When everything is correct, click Change IP Settings.

After you confirm the change, a message appears stating that the change was successful and that the device will restart. Restarting may take 10 to 20 seconds to complete. When you see the following indicator, the device is ready for use with its new address:

- The SNAP-PAC-S1's, SNAP-PAC-R1's, and SNAP-PAC-R1-B's STAT LED shows solid green or solid orange when viewed from the top (green means a strategy is running; orange means no strategy is running).
- The SNAP-PAC-EB1's or SNAP-PAC-EB2's STAT LED shows solid green.
- The SNAP Ethernet-based brain's STD LED blinks twice.
- The STAT LED on an E1 or E2 stops blinking and stays on.

Remember to write the IP address on the sticker or white area on the device.

## INSTALLING NEW FIRMWARE

*NOTE: To load firmware on an R-series controller secured with a private key using PAC Terminal Secure Strategy Distribution (SSD), see the technical note provided with the purchase of SSD. If you follow the procedures documented here, you'll get an error.*

All SNAP PAC controllers and brains<sup>1</sup>, and SNAP serial communication modules, contain firmware. If a new version of the firmware is released or if the firmware should become damaged, you can use PAC Manager to load new firmware to the device.

Typically, firmware files are created for a specific series of products (for example, firmware for the R1 series, which includes SNAP-PAC-R1, -R1-B, and R1-FM controllers). Firmware files have the file extension “.bin.” Sometimes we package firmware files for multiple series of products in a zip file. If you've downloaded a firmware zip file from our website, you'll need to unzip it to access the individual .bin files.

To get the newest firmware file, you can use the Get Latest Firmware feature in PAC Manager (or any browser like Google Chrome, Mozilla Firefox, and Microsoft Edge) to [download the firmware](#) from Opto 22's website<sup>2</sup>.

If your SNAP PAC controller has a microSD card slot, you can copy the necessary .bin files to the microSD card, and then load the firmware from the card. This method can be easier if your PAC isn't networked. (For instructions to load firmware from a microSD card, see the controller user's guide.)

Typically, PAC software requires a matching (or higher) version number of controller firmware. This is because the firmware must be able to support new features in the software. It's usually OK to have controller firmware that is newer (that is, has a higher version number) than the version of PAC software you have. There can be exceptions, however—such as when a change in the firmware requires a matching change in the software. PAC Control keeps track of the dependencies between different versions of controller firmware and software, and will display a warning when the controller firmware is lower than the minimum version number recommended for your software. (The warning is displayed in PAC Control when you try to go into Debug mode to download a strategy.)

The steps to load new firmware depend on the type of device you have, and whether the device's current firmware is damaged.

- For **legacy brains** (SNAP Ethernet I/O and SNAP Simple I/O brains, and SNAP Ultimate I/O brains with a *firmware version lower than R5.0*), see the instructions in the [SNAP Ethernet-Based I/O Units User's Guide](#) (form 1460).
- To load firmware for **SB brains**, see [page 229](#).
- To load firmware for **serial communication modules**, see [page 232](#).
- For **all other controllers and brains** (including SNAP Ultimate brains with *firmware R5.0 or higher*), see [page 226](#).
- To load **I/O coprocessor** firmware, see [page 233](#).
- To **replace damaged firmware** (indicated by three slow red blinks of the STAT LED after powerup), see [page 236](#).

### Firmware Loading's Effect on Data in the Device

Successfully loading firmware to a controller or brain erases (clears) all data in volatile memory (RAM) and in non-volatile memory (battery-backed RAM).<sup>3</sup> This includes:

<sup>1</sup>In addition, rack-mounted controllers and brains manufactured starting in 2016 may contain an I/O coprocessor, which has its own firmware. For details, see [page 233](#).

<sup>2</sup>To download previous versions of Opto 22 firmware and software, go to our FTP site at [ftp://ftp.opto22.com/Public\\_Folders\\_\(Unsecured\)/Archives\\_\(Software\\_and\\_Firmware\)/](ftp://ftp.opto22.com/Public_Folders_(Unsecured)/Archives_(Software_and_Firmware)/)

<sup>3</sup>I/O coprocessor firmware is *not* cleared when you update controller or brain firmware. For details, see [page 233](#).

- The PAC Control strategy
- All strategy variables, including persistent variables
- The PAC Control strategy's Autorun flag
- I/O point, Event, and PID loop configurations
- Scratch pad values
- User files
- Any other memory map configurations

The following items are cleared from flash memory:

- The PAC Control strategy
- The PAC Control strategy archive

If the following items have been stored to flash memory, they are *not* cleared by a firmware load:

- I/O point, Event, and PID loop configurations.
- Scratch pad values.
- User files.
- Some memory map configuration items. (Note that some memory map configuration items *are* cleared by a firmware load. For details, see the [OptoMMP Protocol Guide](#), form 1465.)

A successful firmware load also restarts the device. Restarting a device causes data in volatile memory and in battery-backed RAM to be lost. This means that accumulated data (such as counts from analog and digital totalizers) is reset. For these reasons, you shouldn't attempt to load firmware to **devices that are running**.

And what happens if you select the wrong IP address?

- If the IP address you select is for an Opto 22 device that doesn't match with the firmware type (for example, your controller is a SNAP-PAC-R1 and you try to load EB2 firmware), nothing on your controller is erased. PAC Manager simply displays an error in the Results area and it won't attempt to install the firmware.
- If you select an IP address that is not an Opto 22 device (for example, the IP address belongs to a network printer), nothing on your controller is erased. PAC Manager displays an error in the Results area and it won't attempt to install the firmware.
- If you mistakenly select an IP address for an Opto 22 device that matches the firmware file (for example, you load R1 firmware to an R1 unit that you *don't* want to update), PAC Manager installs the firmware with the same effects listed [above](#).

For these reasons, you should be careful when selecting the IP addresses of devices to load firmware to.

PAC-S  
PAC-R  
EB  
UIO  
E1  
E2

### Loading Controller and Brain Firmware (Except SB Brains)

*For troubleshooting, see [page 228](#).*

*For SB brains, see [page 229](#).*

*To replace damaged firmware, see [page 236](#).*

Use the steps in this section to load PAC firmware on:

- SNAP PAC controllers
- SNAP PAC EB brains
- E1 and E2 brain boards
- SNAP Ultimate brains with firmware version R5.0 or higher

Before beginning, be sure to have:

- Address information for the controller(s) and/or brain(s) that will receive the new firmware.
- The PAC firmware file for your product, or Internet access to download the firmware from [our website](#).

1. If PAC Manager isn't already open it, start it. (For instructions, see the footnote on [page 16](#).)
2. Click the Maintenance button .

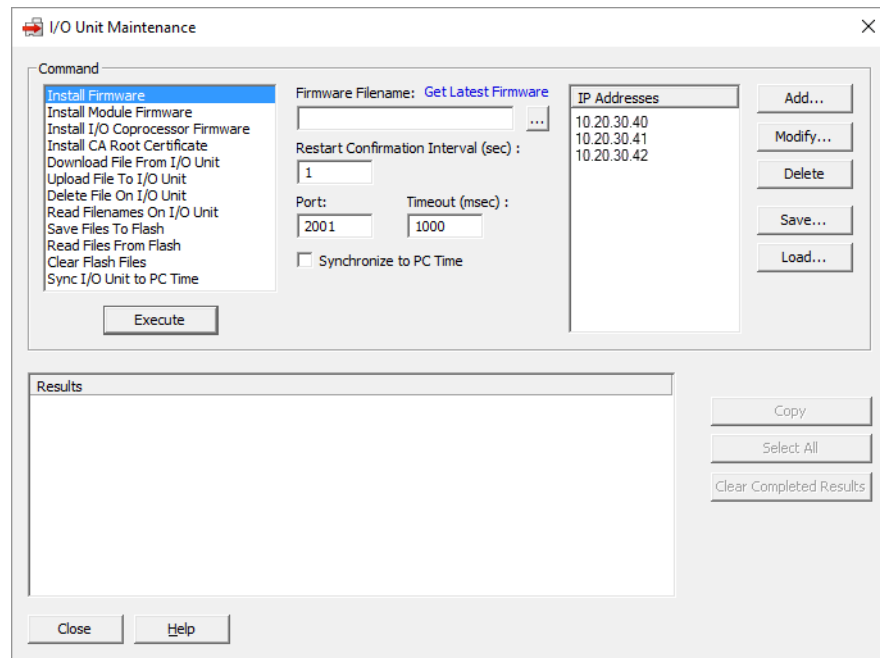

3. Make sure Install Firmware is highlighted in the Command list.
4. If you already have the firmware file on your computer, network, or microSD card, skip to [step 5](#).  
If you need to get the new firmware file:
  - a. Click the blue Get Latest Firmware link.  
The link opens your browser and takes you to the Downloads section of our website, [www.opto22.com](http://www.opto22.com).
  - b. On the Downloads webpage, choose the firmware for your part number, and then download it to your PC. Firmware files have the file extension ".bin." Sometimes we package firmware files for multiple series of products in a zip file. If you've downloaded a firmware zip file from our website, you'll need to unzip it to access the individual .bin files.
5. In PAC Manager's I/O Unit Maintenance dialog box, click the browse button , and then navigate to the firmware (.bin) file for your product.  
Double-click the file to select it. The dialog box closes, and the path and filename appear in the Firmware Filename field.
6. If the SNAP devices you want to update are displayed in the IP Addresses list, skip to [step 7](#).  
If you have previously saved a list of IP addresses and want to use the list, click Load to select and load the saved list, and then skip to [step 7](#).

## INSTALLING NEW FIRMWARE

If the IP address you want isn't displayed, click Add, and then enter a device's IP address or host name, or a range of consecutive IP addresses.

Choose one of these options to add IP addresses:  
Type a single IP address here.

Enter a host name here.

To enter a range of IP addresses, click here, and then enter the From and To addresses.

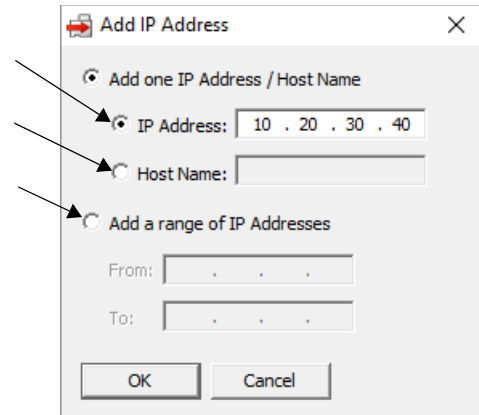

When you've finished adding IP addresses, click OK.

7. In the IP Addresses list, highlight the IP addresses to send firmware to. To select multiple devices, hold down the Ctrl key as you click the devices.

*NOTE: Do not multi-select daisy-chained or multi-dropped -EB series Ethernet brains. You must update their firmware **one device at a time**.*

In this example, these devices will receive the firmware update.

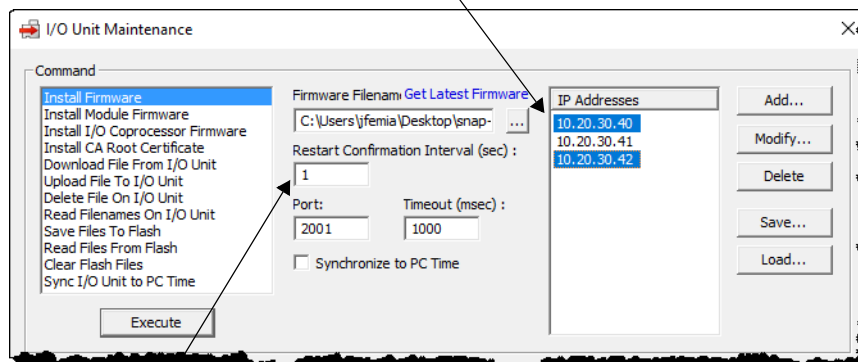

You can change the amount of seconds PAC Manager waits before verifying the devices have restarted.

8. If you have changed the OptoMMP port (see [page 94](#)), enter the correct port number in the Port field.
9. **CAUTION:** Loading firmware erases the current firmware in the selected device. **You cannot undo the erase.** Make sure you've highlighted the IP addresses you want to update, and not others by accident. For details, see "[Firmware Loading's Effect on Data in the Device](#)" on [page 225](#).

To load the firmware, click Execute.

The file is loaded to the SNAP devices, and progress is shown in the Results area.

When the file has completed loading and the devices are restarted, a "Success" message is displayed in the Results area.

### Troubleshooting

- If, during the firmware update process, a Timeout error message appears in the Results area, you can try temporarily disabling any firewalls on the computer running PAC Manager.

Firewalls, such as the ones that come with some anti-virus software programs and the built-in firewall in Windows, can prevent PAC Manager from receiving FTP communications from the controller, which will result in a timeout error. (Firewalls in a router shouldn't be a problem.)

You can reenable the firewalls after loading the firmware.

- **If disabling firewalls is not an option**, you can try
  - Connecting the PC directly to the controller or brain.
  - Configuring a firewall exception for PAC Manager.  
To configure a firewall exception in your system's anti-virus software, see the manufacturer's instructions.  
To configure a firewall exception in Windows, see [page 16](#).
- If you're using EB brains in a daisy-chain or multi-dropped configuration, you must update their firmware *one device at a time*. This is because, after the firmware update, network communication is disrupted when each brain in the chain is restarted.
- You may encounter an issue if you're updating an R-series controller that has PAC firmware R9.2c or lower. This issue is resolved, and details are available on our website, OptoKnowledgeBase article KB82101 [http://www.opto22.com/site/knowledgebase/kb\\_view\\_article.aspx?aid=2059](http://www.opto22.com/site/knowledgebase/kb_view_article.aspx?aid=2059)
- You may encounter an issue in either of these situations:
  - You're updating an R-series controller with a microSD card slot and PAC firmware R9.5a or lower. (Wireless controllers are not affected.)
  - A microSDHC card is inserted in your R-series controller when you're updating PAC firmware R9.5a or lower. (Wireless controllers are not affected.)
 These issues have been resolved. For details, see our website:
  - OptoKnowledgeBase article KB86172 [http://www.opto22.com/site/knowledgebase/kb\\_view\\_article.aspx?aid=2962](http://www.opto22.com/site/knowledgebase/kb_view_article.aspx?aid=2962)
  - OptoKnowledgeBase article KB86180 [http://www.opto22.com/site/knowledgebase/kb\\_view\\_article.aspx?aid=2945](http://www.opto22.com/site/knowledgebase/kb_view_article.aspx?aid=2945)

**SB**

### Loading SB Brain Firmware

These instructions apply to SNAP PAC SB brains. For other brains and controllers, see [page 226](#).

*NOTE: For an SB brain that has damaged firmware (indicated by three slow red blinks of the STAT LED after powerup), see [page 236](#).*

**Before beginning**, make sure you have an Internet connection to obtain the firmware. Also, choose how you will connect to the SB brain (for more information, see the brain user's guide):

- Through the S-series controller—see steps in “[Installing SB Firmware Through the Controller](#),” below.
- Directly from the PC to the brain (requires a PCI-AC48 adapter card in the PC)—see “[Installing SB Firmware Directly from PC to Brain](#)” on [page 231](#).

#### Installing SB Firmware Through the Controller

1. If PAC Manager isn't already open, start it. (For instructions, see the footnote on [page 16](#).)

- In the PAC Manager menu bar, click Tools > Install Firmware via Ethernet.

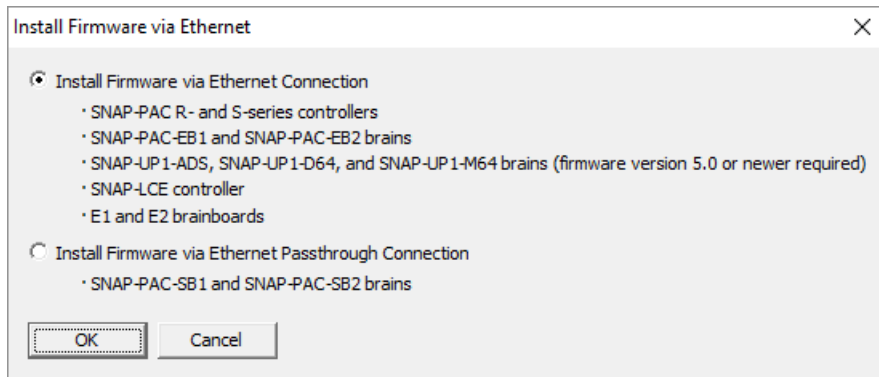

- Click Install Firmware Through Ethernet Passthrough Connection, and then click OK.

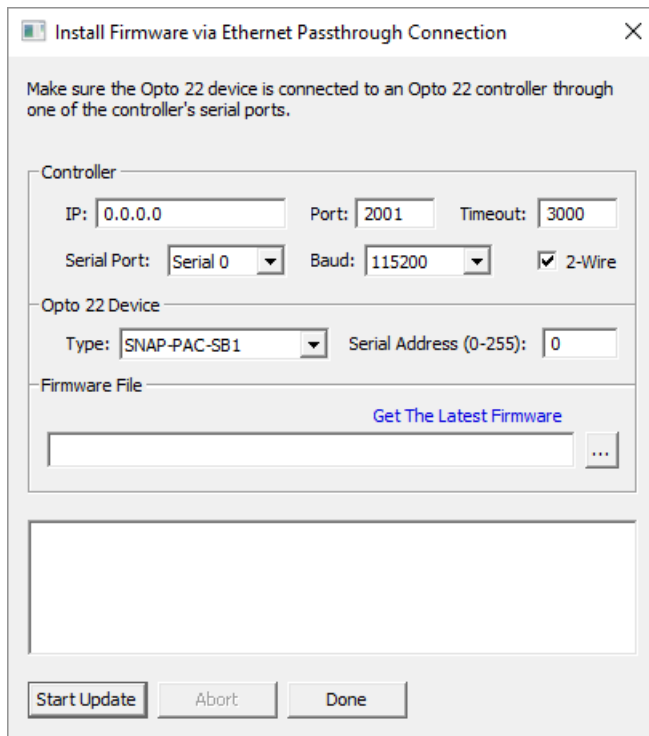

- In the Controller section, enter the IP address of the controller. Leave the Port at 2001 unless you have changed it. Choose the serial port on the controller that the brain is connected to, and make sure the baud rate matches that on the brain. Change Timeout and 2-Wire if necessary.
- In the Opto 22 device section, choose the type of SB brain and enter its serial address.
- Click the blue Get Latest Firmware link.  
The link opens your browser and takes you to the Firmware Downloads section of our website, [www.opto22.com](http://www.opto22.com).
- Choose the firmware for your part number from the list and download it to your PC.  
If you have any difficulty obtaining or loading new firmware, contact Opto 22 Product Support.
- Click the browse button and locate the firmware file you just downloaded. Double-click the filename.



The path and filename appear in the Filename field.

9. When all the fields are correct, click Start Update.

Progress is shown in the lower part of the window. When the process is complete, the device is ready to use.

### Installing SB Firmware Directly from PC to Brain

This method requires a serial connection from the brain to the PC, via an RS-485 converter such as an Opto 22 PCI-AC48 adapter card.

1. If PAC Manager isn't already open it, start it. (For instructions, see the footnote on [page 16](#).)
2. In the PAC Manager menu bar, click Tools > Install Firmware via Serial Connection.

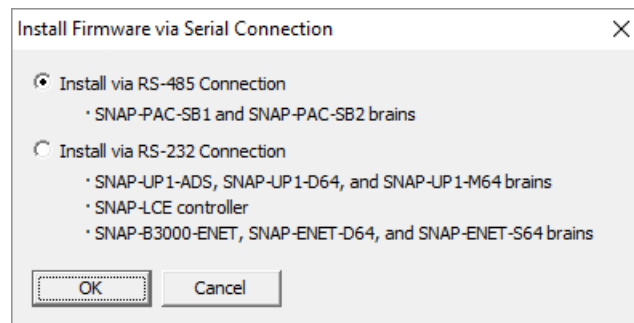

3. Click Install via RS-485 Connection.

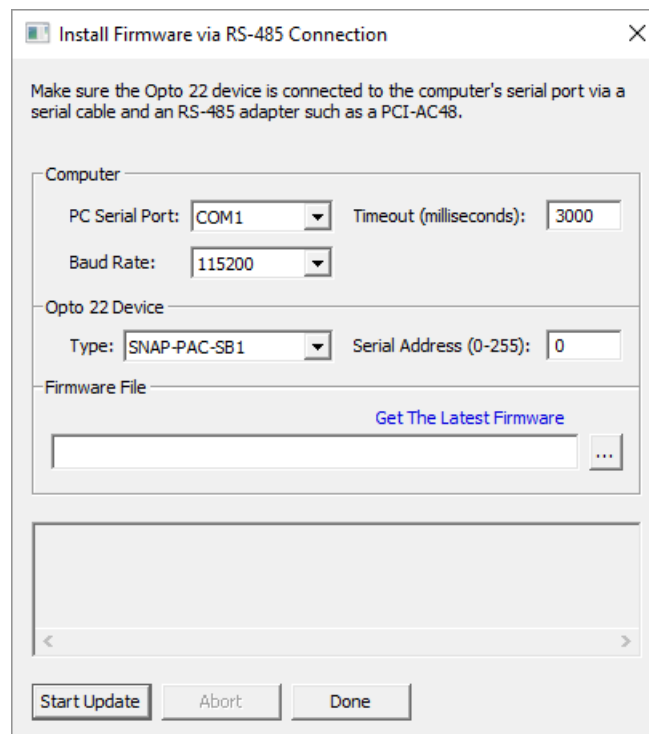

4. In the Computer section, choose the COM port the brain is connected to. Make sure the baud rate matches that on the brain. Change the Timeout if necessary.
5. In the Opto 22 Device section, choose the type of SB brain and enter its serial address.

6. Click the blue Get The Latest Firmware link.  
The link opens your browser and takes you to the Firmware Downloads section of our website, [www.opto22.com](http://www.opto22.com).
7. Choose the firmware for your part number from the list and download it to your PC.  
If you have any difficulty obtaining or loading new firmware, contact Opto 22 Product Support.
8. Click the browse button  and locate the firmware file you just downloaded. Double-click the filename.  
The path and filename appear in the Filename field.
9. When all the fields are correct, click Start Update.  
Progress is shown in the lower part of the window. When the process is complete, the device is ready to use.

**PAC-R  
EB  
UIO**

### Loading Serial Module Firmware

If you have a SNAP PAC I/O unit, or a SNAP Ultimate I/O unit with firmware version 5.0 or higher, you can load new serial module firmware to a SNAP serial communication module on the I/O unit. (If you want to update the SNAP Ultimate I/O unit to newer firmware so you can use this procedure, follow the steps in the [SNAP Ethernet-Based I/O Units User's Guide](#)

*NOTE: If the serial module is on a SNAP Ethernet or SNAP Simple I/O unit, contact Opto 22 Product Support for assistance. Contact information is on [page 4](#).*

1. Make sure you have an Internet connection so you can download the new serial module firmware file.
2. If PAC Manager isn't already open it, start it. (For instructions, see the footnote on [page 16](#).)
3. In the PAC Manager main window, click the Maintenance button .
4. In the Command list, highlight Install Module Firmware.

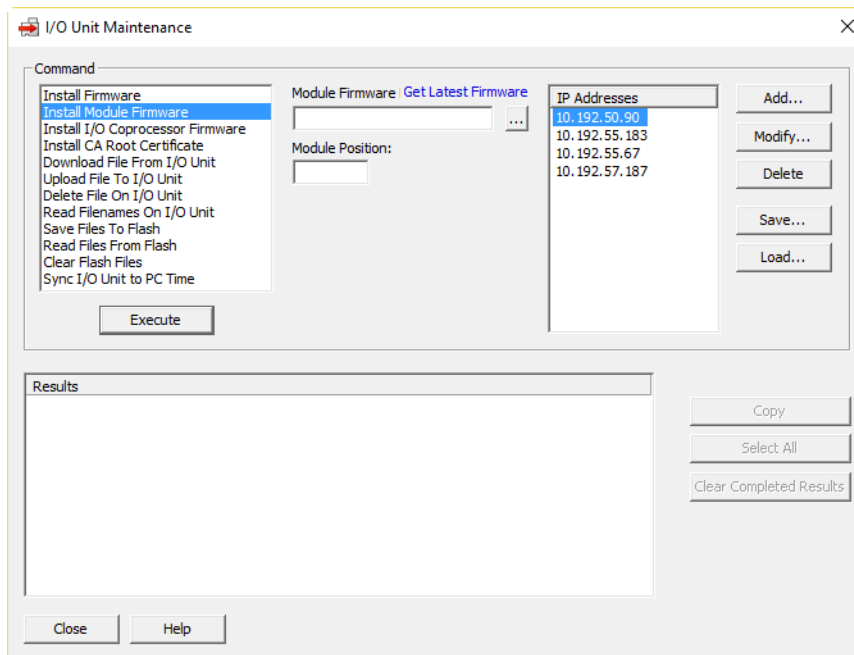

5. Click the blue Get Latest Firmware link.  
The link opens your browser and takes you to the Firmware Downloads section of our website, [www.opto22.com](http://www.opto22.com).

6. Choose the firmware for your part number from the list and download it to your PC.  
If you have any difficulty obtaining or loading new firmware, contact Opto 22 Product Support.
7. Click the browse button  and locate the serial module firmware file you just downloaded.  
Double-click the filename.  
The path and filename appear in the Filename field.
8. In the Module Position field, type the serial module's position on the rack (0–15).
9. In the IP Addresses list, highlight the IP address of the I/O unit the serial module is on. (If the correct IP address is not shown, click Add to add it.)  
You can load serial module firmware to multiple I/O units at the same time, but only if the modules are in identical positions on all I/O units.
10. Click Execute.  
The serial module firmware file is loaded to the I/O unit and then loaded to the serial module, and a Success message appears in the Results area.

PAC-R  
EB  
SB

### Loading I/O Coprocessor Firmware

For information about loading PAC firmware, see [“Installing New Firmware” on page 225](#).

The SNAP PAC I/O coprocessor is a programmable chip that can be updated in newer Opto 22 rack-mounted controllers and brains. It replaces an older, obsolete chip. The change has no effect on function or performance.

The new programmable chip is included in Opto 22 rack-mounted controllers and brains, starting with the date codes listed below.

*NOTE: For devices manufactured **during** the month and year listed, use PAC Manager to find out if your device has an I/O coprocessor. (For details, see [page 234](#).)*

Product	Manufacturing Date Code (MM/YY)
SNAP-PAC-R1, -R1-FM, R1-W	06/16
SNAP-PAC-R1-B	01/16
SNAP-PAC-R2, -R2-FM, R2-W	02/16
SNAP-PAC-EB1, -EB1-FM, EB1-W	03/17 (See <a href="#">Note</a> )
SNAP-PAC-EB2, -EB2-FM	08/16
SNAP-PAC-EB2-W	03/17
SNAP-PAC-SB1	05/17 (See <a href="#">Note</a> )
SNAP-PAC-SB2	06/17 (See <a href="#">Note</a> )

#### Special Note about EB1s, SB1s, and SB2s

As of November 14, 2017, the following products manufactured with I/O coprocessors have firmware R3.0a. At this time, you do not need to update the firmware in these products.

- SNAP-PAC-EB1
- SNAP-PAC-EB1-FM
- SNAP-PAC-EB1-W
- SNAP-PAC-SB1
- SNAP-PAC-SB2

#### Does My Product Have an I/O Coprocessor?

A device's manufacturing date code can rule out whether the device has an I/O coprocessor, but to know for certain, you can inspect the device in PAC Manager.

**Using the Manufacturing Date Code**

If your device is easily accessible, you can visually check its manufacturing date code to see when it was manufactured. If it was manufactured before the dates listed in the table on [page 233](#), it doesn't have a chip that can be updated.

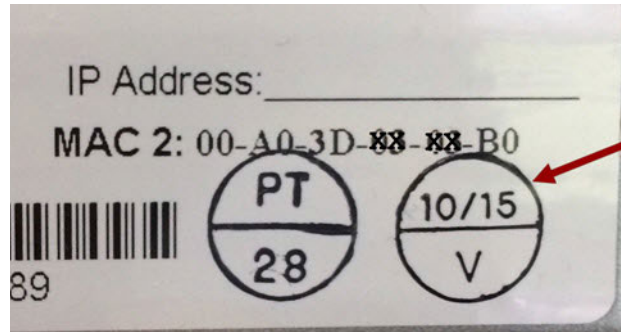

The manufacturing date code (month and year in MM/YY format) appears in the top half of a bisected circle, printed on a white label attached to the device.

**Using PAC Manager R9.5a or higher**

1. In PAC Manager, click Tools > Inspect to open the Inspect Opto 22 Device window.
2. In the Device Name field, select or enter your device.
3. Look at the Value for I/O Coprocessor Firmware Version.

If the Value is A0.0a or 0 (zero), your device *does not* have an I/O coprocessor.

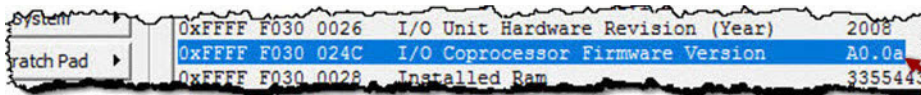

These devices don't have an I/O coprocessor.

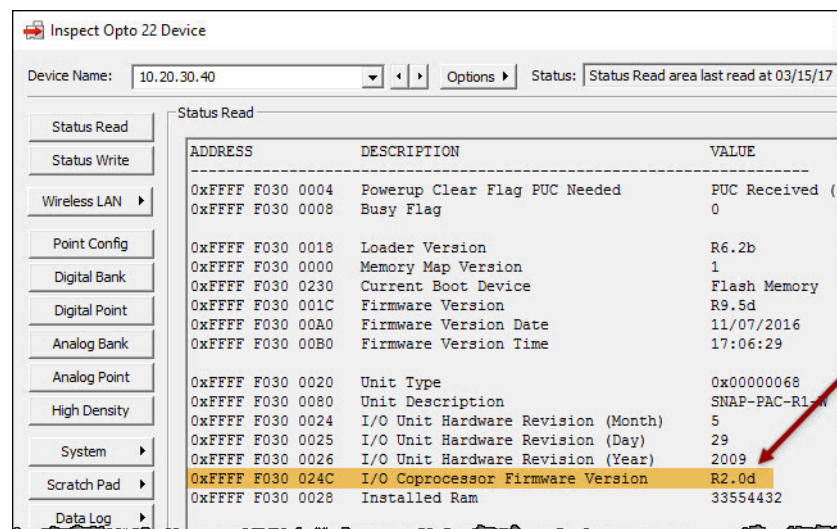
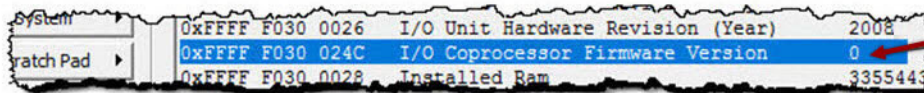

This device has an I/O coprocessor. You should update its firmware.

**Using PAC Manager R9.4c or lower**

1. To verify you can connect to your controller or brain, click Tools > Inspect. Then, in the Device Name field, select or enter your device, and press Enter (or click Refresh).

2. If you're connected, click Other > Generic Read/Write.
  - a. In the Address: 0x FFFF field, type: F030024C
  - b. In the Type field, select: 32-Bit Integer
3. Click Refresh.

If the Value is not 0 (zero), your device *has* an I/O coprocessor, and you should update its firmware.

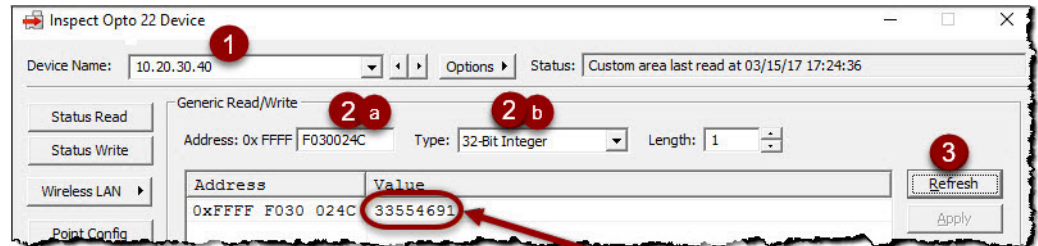

A number in the Value field means the device has an I/O coprocessor. Your device's number may be different.

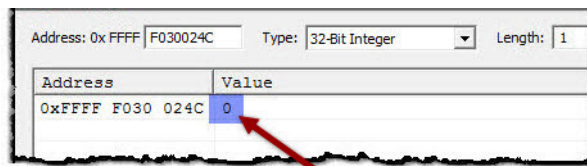

This device doesn't have an I/O coprocessor.

### Getting and Loading the I/O Coprocessor Firmware

I/O coprocessor firmware updates are posted on the [Opto 22 website](#). To successfully load the I/O coprocessor firmware, you must have both:

- PAC Manager R9.5a or higher
- PAC Firmware R9.5a or higher in the device that you're updating

If your device has PAC firmware R9.4c or lower and you aren't ready to upgrade to a newer version of PAC firmware, follow these steps:

1. Temporarily load PAC firmware R9.5a (or higher).
2. Follow the instructions [below](#) to load the I/O coprocessor firmware.
3. Load your previous version of PAC firmware (to overwrite the higher version you installed in step 1).

*Previous versions of software and firmware are available from our FTP site:*

[ftp://ftp.opto22.com/Public\\_Folders\\_\(Unsecured\)/Archives\\_\(Software\\_and\\_Firmware\)/](ftp://ftp.opto22.com/Public_Folders_(Unsecured)/Archives_(Software_and_Firmware)/)

#### To get the I/O coprocessor firmware update file:

Go to the Downloads section of the [Opto 22 website](#), choose the firmware for your part number, and then download it to your PC. Firmware files have the file extension ".bin."

*NOTE: If your device is wireless, select the file for the comparable controller or brain. For example, if you have a SNAP-PAC-R1-W, select the file for the R1 controller, SNAP-PAC-R1-IO-Coprocessor-R3.0a.bin.*

Sometimes we provide firmware files for multiple series of products in a zip file. If you've downloaded a firmware zip file from our website, you'll need to unzip it to access the individual .bin files.

#### To load the I/O coprocessor firmware:

**CAUTION:** Updating the I/O coprocessor firmware will reboot your controller or brain. It will not overwrite your configuration data, but the reboot will cause accumulated data (such as counts from analog and digital totalizers) to be reset.

1. In PAC Manager, open the I/O Unit Maintenance window (Tools > Maintenance).
2. In the Command list, select Install I/O Coprocessor Firmware.
3. Click the Browse button, and then navigate to the folder containing the firmware files.
4. Select the firmware file for your controller or brain, and then click Open.

*NOTE: If your device is wireless, select the file for the comparable controller or brain. For example, if you have a SNAP-PAC-R1-W, select the file for the R1 controller, SNAP-PAC-R1-IO-Coprocessor-R3.0a.bin.*

5. In the IP Addresses list, click the device you want to update.  
Use the Add button to add devices to the list.  
To select multiple devices, hold down the Ctrl key as you click the devices.

*NOTE: Do not multi-select daisy-chained or multi-dropped -EB series Ethernet brains. You must update their firmware **one device at a time**.*

6. Click Execute to load the firmware.

After the file is loaded and the devices are restarted, a "Success" message appears in the Results area.

If the load fails (for example, if the file you selected isn't compatible with your device), the device's I/O coprocessor firmware is not changed or overwritten. However, the **device will restart**, and a "Fail" message appears in the Results area.

If you select a device that does not have an I/O coprocessor, or if the device has SNAP PAC firmware R9.4c or lower, the Results area displays "Command not supported in the build," and the device does not automatically restart.

PAC-S  
PAC-R  
EB  
SB

### Replacing Damaged Firmware

If the STAT LED on a controller or brain blinks red slowly three times after powerup, the firmware in the device is damaged. For details, see the Blink Codes section in the device's user guide.

Follow these steps to replace damaged firmware.

1. Make sure you have the following before beginning:
  - Address information for the controller(s) and/or brain(s) that will receive the new firmware.
  - Internet access to obtain new firmware from our website.
2. Follow instructions in the device's user guide to restart the device in failsafe bootloader mode. Watch for the blink code to make sure the device is in this mode.
3. Attach the PC with PAC Manager to the controller or brain using a crossover cable or "straight-through" Ethernet cable as required:
  - EB-series brains can be connected with either type of cable.
  - Computers with a Gigabit Ethernet network interface controller (NIC) card can use either type of cable (because the NIC card has the ability to adapt.)
  - For R-series and S-series controllers that:
    - Have an SD card slot, use a straight-through Ethernet cable.
    - Do not have an SD card slot, use a crossover cable.
  - For SB-series brains:
    - Connect through the S-series controller;
    - Or connect directly from the PC using a serial cable and a PCI-AC48 adapter card.

For more information on connections, see the device's user's guide.

4. If PAC Manager isn't already open it, start it. (For instructions, see the footnote on [page 16](#).)
5. In the PAC Manager menu bar, click Tools > Install Firmware via Failsafe Bootloader Mode. Click OK at the message about products it can be used with.

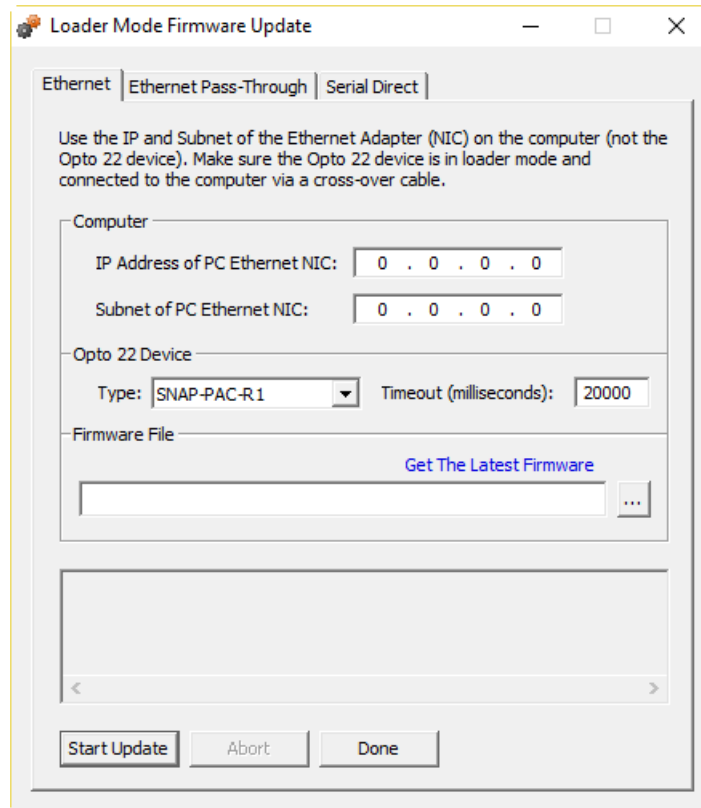

6. Choose one:
  - For a SNAP PAC controller or EB brain, click the Ethernet tab and continue with [step 7](#).
  - For an SB brain, if you're connecting to the brain through the S-series controller, click the Ethernet Pass-Through tab and skip to [step 8](#).
  - For an SB brain, if you're connecting serially from the PC to the brain, click the Serial Direct tab and skip to [step 9](#).
7. For a controller or EB brain, enter the IP address and subnet of *the PC* (not the controller or brain). Choose the controller's or brain's device type from the drop-down list. Skip to [step 10](#).
8. For an SB brain using Ethernet Pass-Through, do the following:
  - In the Controller section, enter the IP address of the controller. Leave the Port at 2001 unless you have changed it. Choose the serial port on the controller that the brain is connected to, and make sure the baud rate matches that on the brain.
  - In the Opto 22 device section, choose the type of SB brain and enter its serial address. Skip to [step 10](#).
9. For an SB brain using Serial Direct, do the following:
  - In the Computer section, choose the COM port the brain is connected to. Make sure the baud rate matches that on the brain.
  - In the Opto 22 device section, choose the type of SB brain and enter its serial address. Go on to [step 10](#).
10. Click the blue Get Latest Firmware link.

## INSTALLING CA ROOT CERTIFICATES



The link opens your browser and takes you to the Firmware Downloads section of our website, [www.opto22.com](http://www.opto22.com).

11. Choose the firmware for your part number from the list and download it to your PC.  
If you have any difficulty obtaining or loading new firmware, contact Opto 22 Product Support.
12. Click the browse button  and locate the firmware file you just downloaded. Double-click the filename.  
The path and filename appear in the Filename field.
13. When all the fields are correct, click Start Update.  
Progress is shown in the lower part of the window. When the process is complete, either repeat from [step 7](#) for another device, or click Done.  
The device is now ready to use.

## INSTALLING CA ROOT CERTIFICATES

*NOTE: As part of the process of installing the certificate on the controller, **the controller will be restarted** to activate the certificate. You may need to schedule a system shutdown to coordinate putting the certificate on the controller and rebooting the controller.*

To place a root certificate in the /pki/root-certs folder on your controller:

1. In the PAC Manager menu bar, click Maintenance .
2. In the Command list, select Upload File To I/O Unit.
3. Click the Browse button  and browse to the location of the certificate. Select the certificate, and then click OK.
4. In the Destination field, type /pki/root-certs/ and the name you want the certificate to have on the controller; for example:  
`/pki/root-certs/Equifax_Secure_Certificate_Authority.cer`
5. Select the IP address of the SNAP PAC device that you want to install the certificate on.

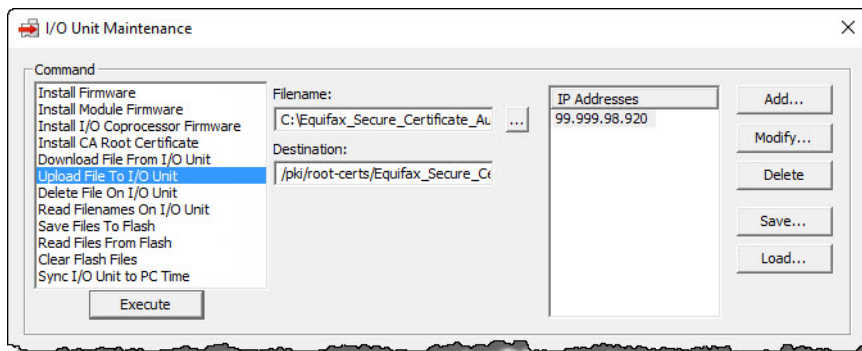

6. Click Execute.
7. (Optional) Repeat steps 2–6 if you have additional certificates to install.
8. Select the Save Files To Flash command, and then click Execute.
9. Restart the SNAP PAC device to activate the certificates.



## MAINTAINING FILES

**PAC-S  
PAC-R  
SoftP  
EB  
UIO**

This section applies to SNAP PAC EB brains, PAC R, PAC S, and SoftPAC controllers, and to SNAP Ultimate controller/brains with firmware version 5.0 or higher. SNAP Ethernet brains, SNAP Simple brains, E1 and E2 brain boards with E1/E2 firmware R1.1f and lower, and Ultimate brains with older firmware do not have file capability. To update a SNAP Ultimate controller/brain to the newer firmware, see the brain user's guide.

*NOTE: The [E1 and E2 User's Guide](#) (form 1563) describes the limited use of PAC Manager to FTP-specific files to an E1 or E2 I/O unit.*

The memory in a SNAP PAC or SNAP Ultimate controller (firmware version 5.0 and higher) includes a substantial area available for file storage:

SNAP-PAC-S1 SNAP-PAC-S1-FM SNAP-PAC-S1-W	SNAP-PAC-S2 SNAP-PAC-S2-W	2.5 MB
SNAP-PAC-R1 SNAP-PAC-R1-B SNAP-PAC-R1-FM SNAP-PAC-R1-W	SNAP-PAC-R2 SNAP-PAC-R2-FM SNAP-PAC-R2-W	2.0 MB
SoftPAC		Limited only by the size of the hard drive on the computer the software runs on.
SNAP-PAC-EB1 SNAP-PAC-EB1-FM SNAP-PAC-EB1-W	SNAP-PAC-EB2 SNAP-PAC-EB2-FM SNAP-PAC-EB2-W	2.0 MB
SNAP Ultimate		2.0 MB

In addition, beginning in early 2009, microSD slots were added to S-series and R-series PACs for removable storage up to 2 GB.

In the file storage area or on a suitable removable disk, you can store any types of files. These files can be sorted into directories or folders just as they can on a PC, and they are available for use within a PAC Control strategy or an application you develop. For example, the SNAP device can read the files, add data to them, and even send data from them via FTP to another device on the network.

**For managing general data files on a microSD card**, see instructions in the Maintenance chapter of the controller user's guide. Do not use PAC Manager for general microSD file management. However, you can use PAC Manager for some functions related to firmware, strategy, and configuration files on the card. See ["Using microSD Commands"](#) on page 215.

**To use PAC Control strategy logic to create and manage files**, see "Communication Commands" in Chapter 10 of the [PAC Control User's Guide](#).

### Tools for Managing Files

There are several tools you can use to manage files. You can use FTP software or even Windows Explorer to move files to and from the device via FTP, and you can use PAC Manager to move and manage files on the device. Here are some additional details:

- **PAC Control** lets you programmatically work with the SNAP controller or I/O unit's file system, within your control strategy. You can create files and folders on the device and write to, add data to, or read them; receive file data via FTP; send all or part of the data in a file via FTP, and more. PAC Control works with one I/O unit at a time. A PAC Control strategy can also FTP files to one or more other I/O units or controllers.

- **PAC Manager**'s main advantage for file management over other commercially available FTP client software is that it can work with multiple Ethernet devices at once, for example sending data via FTP to ten I/O units at the same time, or deleting the same file from multiple I/O units simultaneously. However, PAC Manager can see only the folders and files at the root of the device's file system (not the names of files within folders). For this reason, do not use PAC Manager for working with files on a microSD card in the controller, as all of its files are in a directory.
- Newer versions of **Windows Explorer** can be used for FTP operations with a single controller or I/O unit. It's easy to drag and drop files and folders to the device, and you can see the complete file structure. You may find that data isn't always refreshed correctly.
- **Other FTP software** products you can download may be more reliable than Windows Explorer; they also may give you extra features like communication details, which are useful for debugging. Some may not support filenames with spaces or other specific characters. They work with one device at a time.
- You can also use a **command prompt** for FTP, again with one device at a time.
- Note that FTP cannot be used through a firewall in the PC. Make sure any firewall in the computer is disabled before you try to work with files. Firewalls in a router should not be a problem, however.

Keep the following limitations in mind as you work with files on controllers and I/O units:

Maximum length for filenames and directory names	127 characters
Filename characters allowed	All ASCII characters except *, ?, null, and / <i>NOTE: Some FTP client software may not allow spaces or specific characters.</i>
Path name component separator	/
Maximum number of files and directories that can be open simultaneously	16
Maximum directory depth	Limited only by available memory <i>NOTE: PAC Manager reads only the root names; files within folders are not listed.</i>
Maximum number of files	Limited only by available memory. Each file uses 516 bytes of overhead plus its number of bytes rounded up to the nearest multiple of 516 bytes.
Maximum number of directories	Limited only by available memory. Each directory uses 516 bytes.
Maximum amount of memory available in the device's file system	Approximately 2.5 MB on a SNAP PAC S-series, 2 MB on a SNAP PAC R-series or EB brain or Ultimate brain (varies slightly depending on the device's firmware version). Data storage on a SoftPAC controller is limited only by the size of the hard drive on the computer the software runs on.
Maximum amount of memory available in removable storage (per microSD card)	2 GB (available on S-series and R-series PACs)

When using the SNAP device as an FTP server, for example with an FTP client such as CuteFTP, you can use an anonymous login. The device ignores any user ID or password.

*CAUTION: Make sure you save files to flash memory if needed. If power to the controller or I/O unit is turned off, files are destroyed unless they have been saved to flash. (Does not apply to files in removable storage.)*

PAC-S  
PAC-R  
EB  
UIO

## Moving Files to the SNAP Controller or I/O Unit

To move files to the SNAP controller or I/O unit, use any standard FTP client software or PAC Manager. (Do not use PAC Manager for files on a microSD card.) A maximum of five devices can FTP files to a SNAP controller or I/O unit simultaneously.

Follow these steps to move files to the SNAP device using PAC Manager:

1. If PAC Manager isn't already open it, start it. (For instructions, see the footnote on [page 16](#).)
2. Click the Maintenance button .

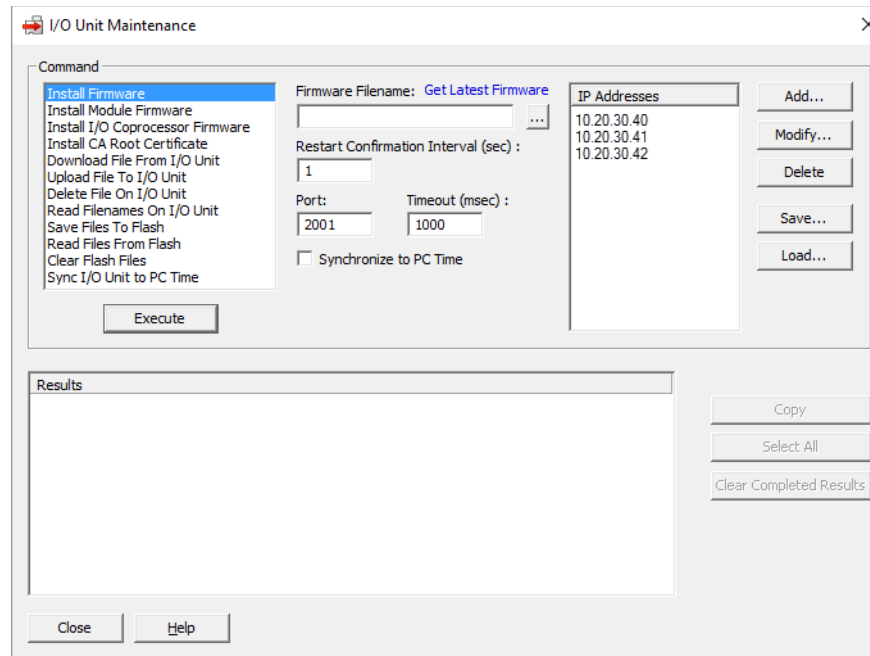

3. In the Command list, highlight Upload File To I/O Unit. Click the browse button  and locate the source file you want to load.
4. In the Destination field, type the filename as you want it to appear on the SNAP device. The filename can be the same or different from the source filename. You can specify a path on the device using the separator / For example, to place the file Product Categories.txt into the folder Products, you would type: Products/Product Categories.txt If the folder does not exist, it is created.

- If the IP address(es) of the device(s) you want to load the file to appear in the IP Addresses list, skip to [step 7](#). (Or, if you have previously saved a list of IP addresses, click Load to load the saved list.) If the address(es) you need don't appear in the list, click Add.

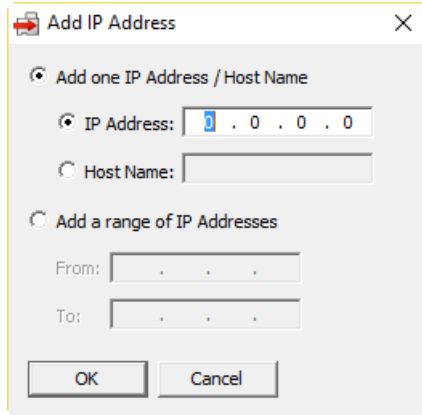

- Enter the address or a range of consecutive addresses, then click OK. The address(es) you entered appear in the I/O Unit Maintenance dialog box.
- Highlight the IP addresses to load the file to.
- Click Execute. The file is loaded to the I/O units, and a Success message appears in the Results area.

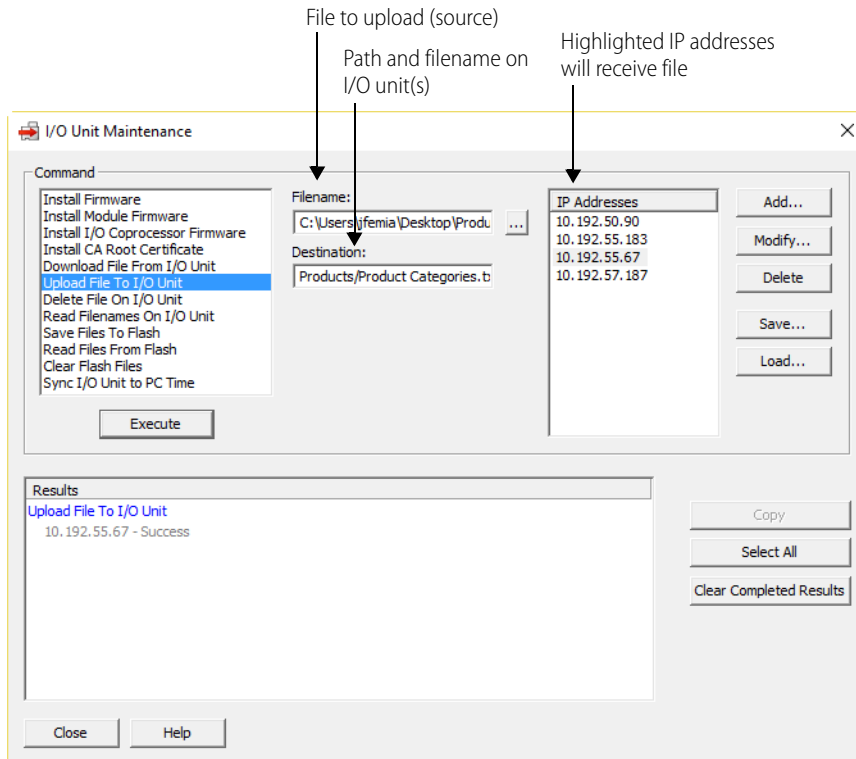

PAC-S  
PAC-R  
EB  
UIO

## Moving Files from the SNAP Controller or I/O Unit

To move files from the SNAPPAC controller or I/O unit, use any standard FTP client software or PAC Manager (do not use PAC Manager for files on a microSD card), or use the FTP communication handle in a PAC Control strategy. (In PAC Control, a maximum of 16 communication handles can be used simultaneously to FTP files. For details, see “Communication Commands” in the *PAC Control User’s Guide* (form 1700).

Here’s how to move files from the device using PAC Manager:

1. In the PAC Manager main window, click the Maintenance button .
2. In the Command list, highlight Download File From I/O Unit.

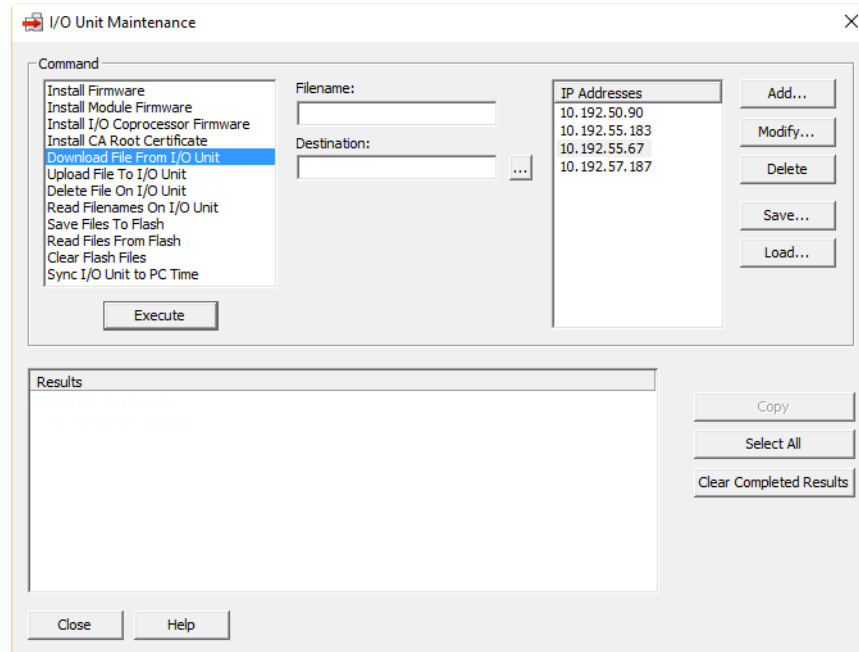

3. In the Filename field, enter the filename (and path, if any) of the file on the controller or I/O unit.  
For example: `Products/Product Categories.txt`
4. In the Destination field, enter the path and filename where you want the file to go (or click the browse button  to locate the path, then type in the filename).  
The filename can be the same or different from the source filename.
5. In the IP Addresses list, highlight the IP address of the SNAP device you are downloading the file from. (If it does not appear, click Add to add it to the list.)
6. Click Execute.  
The file is loaded from the device, and a Success message appears in the Results area.

PAC-S  
PAC-R  
EB  
UIO

## Reading Filenames

You can use PAC Manager to read and list the names of all files and folders in the *root* of the controller or I/O unit. Note that files located inside folders (or folders inside folders) are not listed, even though they are there. PAC Manager will not show any files on a microSD card. You can use a standard FTP software program to see them.

1. In the PAC Manager main window, click the Maintenance button .
2. In the Command list, highlight Read Filenames On I/O Unit.

3. In the IP Addresses list, highlight the IP address of the SNAP device you are reading. (If it does not appear, click Add to add it to the list.)
4. Click Execute.  
The list of root file and folder names appears in the Results area.

All root-level files and folders on the device with the IP address 10.192.55.67.

Folders are designated as <DIR>.

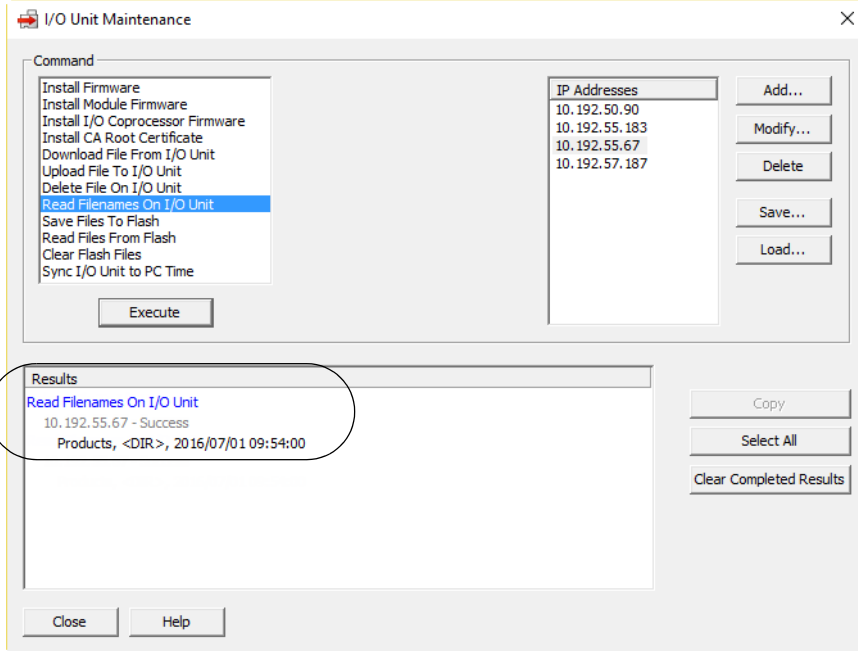

The listing shows the file or folder name, the file's size in bytes (or <DIR> for folders), and the date and time it was placed there (in the format YYYY/MM/DD hh:mm:ss).

PAC-S  
PAC-R  
EB  
UIO

### Deleting a File from a SNAP Controller or I/O Unit

You can also use PAC Manager to delete a file from one device or from several devices at once. (You cannot use it to delete files on a microSD card.)

1. In the PAC Manager main window, click the Maintenance button .
2. In the Command list, highlight Delete File On I/O Unit.
3. In the Filename field, type the filename (and path, if any) of the file you want to delete.  
For example: `Products/Product Categories.txt`
4. In the IP Addresses list, highlight the IP address(es) of the SNAP device(s) you are deleting the file from. (If the correct IP addresses are not shown, click Add to add an address or group of addresses, or if you have saved a list of IP addresses, click Load to load the saved list.)
5. Click Execute.

The file is deleted and a Success message appears in the Results area.

PAC-S  
PAC-R  
EB  
UIO

### Using Flash Memory with the File System

You can use PAC Manager to move files between the controller or I/O unit's file system and its flash memory, which stores files so they are not lost if the device loses power. Remember that flash memory is smaller than the memory available for file storage; check the controller's or I/O unit's data sheet for details. (You cannot use PAC Manager with files on a microSD card.)

You can do any of the following on one or multiple devices:

- Save all files in the file system to flash memory
- Clear all file system files from flash memory (does not affect firmware, strategy files, or point configuration data)
- Load files from flash memory into the device's file system, replacing all files in the file system

Follow these steps:

1. In the PAC Manager main window, click the Maintenance button .
2. In the Command list, highlight the command you want to use.  
In the following example, Save Files To Flash is highlighted.

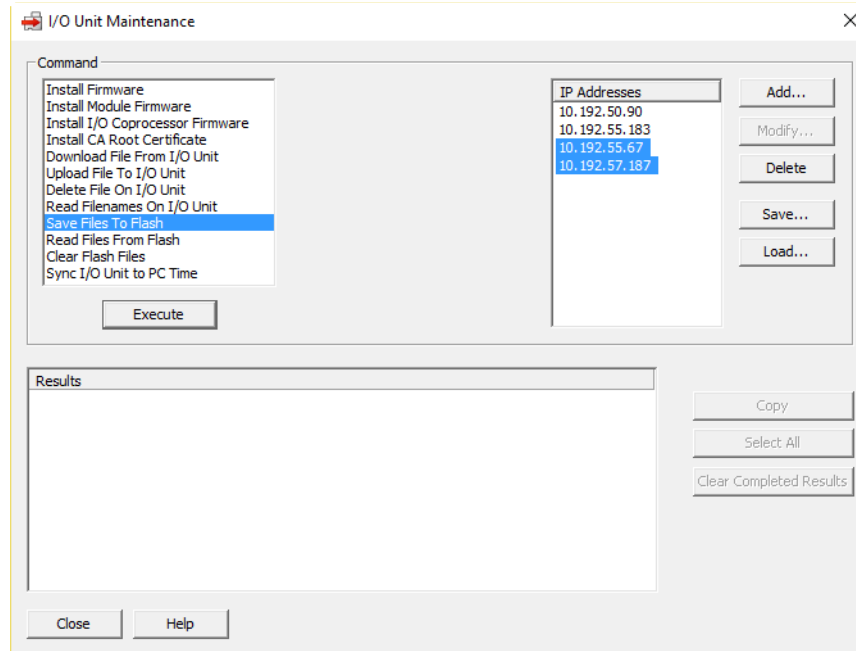

3. In the IP Addresses list, highlight the IP address(es) of the device(s) you want the command to apply to. (If the correct IP addresses are not shown, click Add to add an address or group of addresses, or if you have saved a list of IP addresses, click Load to load the saved list.)

*CAUTION: Make sure you have chosen the correct command and the devices you want to affect. You cannot undo these commands.*

4. Click Execute.  
The command is executed and a Success message appears in the Results area.





# 7: Troubleshooting

## INTRODUCTION

If you are having difficulty using PAC Manager, here are some suggestions that may help. In addition, make sure to check the Troubleshooting section in the device's user's guide. If you cannot find the answers you need in these guides, contact Opto 22 Product Support. For contact information, see [page 4](#).

## PAC MANAGER ERROR MESSAGES

When you send configurations to I/O units in PAC Manager, you may see the following messages in the lower part of the Send Configuration to I/O Unit dialog box:

Message	Notes
Could not open I/O unit: [IP address] or An error occurred while connecting to I/O Unit [IP address].	Timeout error. Check basic communication with the device (See the Troubleshooting appendix in the device's user guide for help).
[number] points successfully configured.	Success message.
Could not configure digital module [number], point [number].	Check the point to make sure it's correct for the module type installed.
Could not configure analog module [number], point [number].	
Module [name] exists at position [number] but was not configured	Check configuration; an analog module is at this position but no points have been configured on it yet.
Could not configure temperature.	These configurations apply to the I/O unit as a whole, not to individual points. Contact Product Support for help. (See <a href="#">page 4</a> .)
Could not configure watchdog.	
Save to Flash—Operation Failed.	Contact Product Support. (See <a href="#">page 4</a> .)
Clear Flash on I/O Unit: [name of unit]—Operation Failed.	
Communication could not be established with the restarted I/O Unit	PAC Manager successfully connected to the device but could not send it a PUC. Check cables and communication.

## TROUBLE CONNECTING TO THE I/O UNIT OR CONTROLLER

See the Troubleshooting section in the user's guide for your device:

- SNAP PAC S-series—the [SNAP PAC S-Series Controller User's Guide](#) (form 1592)
- SNAP-PAC R-series—the [SNAP PAC R-Series Controller User's Guide](#) (form 1595)
- SNAP PAC EB and SB brains—the [SNAP PAC Brains User's Guide](#) (form 1690)
- E1 or E2 I/O units—the [E1 and E2 User's Guide](#) (form 1563)

- SNAP Ultimate, SNAP Ethernet, or SNAP Simple I/O units—the [SNAP Ethernet-Based I/O Units User’s Guide](#) (form 1460)

## USING PAC MANAGER TO TROUBLESHOOT PROBLEMS



PAC Manager can be useful in troubleshooting problems with I/O units and controllers. Before calling Opto 22 Product Support, you can use PAC Manager to get device and firmware information and view diagnostic messages. To help with communication problems, you can change TCP settings. You can also check for Ethernet errors, which indicate network problems.

PAC-S  
PAC-R  
SoftP  
EB  
SB  
UIO  
EIO  
SIO  
E1  
E2

### Getting Device and Firmware Information—Individual Device

These steps provide information for one device at a time. To get information on all devices on the Ethernet network at once, see [page 250](#).

If you need to contact Opto 22 Product Support for assistance in using an I/O unit or controller, it is helpful to have device and firmware information at hand before you call us.

1. Start PAC Manager as follows:
  - In Windows 7, press the Windows Start key , and then click All Programs > Opto 22 > PAC Project > PAC Manager 10.4.
  - In Windows 10, press the Windows Start key , type PAC Manager 10.4 and then press the Enter key.
2. In the PAC Manager main window, click the Inspect button .
3. In the Device Name field, type the name (or IP address) of the device. Click Status Read.

This example shows a SNAP-PAC-S1; other devices are similar.

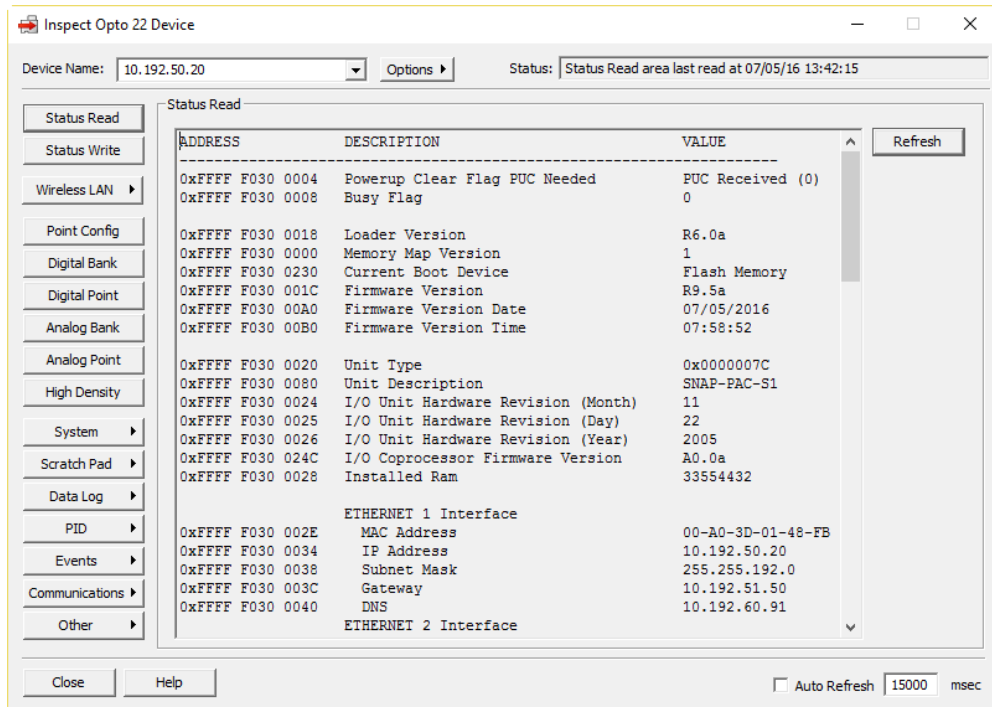

Keep this window open on your screen when you call Product Support.

*NOTE: Because the Status Read area is used for both standalone controllers and I/O units, some items apply to some devices and not others. The following items do not apply to standalone controllers:*

<i>Degrees F/C</i>	<i>PID Loops Supported</i>
<i>Comm Watchdog Time (msec.)</i>	<i>Digital Modules Supported</i>
<i>Scanner Flags</i>	<i>Arcnet data</i>
<i>4-Channel Digital Scan Count</i>	<i>Digital resets and interrupt failures since powerup</i>
<i>Analog &amp; High Density Dig Scan Count</i>	<i>Analog and Digital Scanners (msec per scan)</i>
<i>Smart Modules Present</i>	<i>Module X - Times Discovered</i>

*The following items do not apply to E1 and E2 brain boards:*

<i>Scanner Flags</i>	<i>Ethernet Errors</i>
<i>Digital Scan Counter</i>	<i>Smart Modules Present</i>
<i>Analog Scan Counter</i>	<i>PID Loops</i>
<i>Milliseconds Since Powerup</i>	<i>Arcnet data</i>
<i>TCP Settings</i>	<i>Ethernet/Digital Resets/Failures since Powerup</i>

For help in interpreting Status Read data, see [page 167](#).

### Viewing Diagnostic Messages

PAC Manager displays a Diagnostic Messages button (yellow exclamation mark) on the Status Read page when any of the following conditions are detected:

- The OptoMMP port is not set to the default value of 2001.
- The Modbus port is not set to the default value of 502.
- The SNMP port is not set to the default value of 161.
- The FTP server port is not set to the default value of 21.
- The Control Engine port is not set to the default value of 22001.
- This device is set to Always BootP on Powerup.
- The I/O coprocessor firmware in this device needs to be updated.
- The analog and high density digital scanner is turned off.<sup>1</sup>
- The digital 4-channel scanner is turned off.<sup>1</sup>
- The control engine is turned off.<sup>1</sup>

<sup>1</sup>For more information about scanners, see “Scanner Flags” in “[Changing Status Data](#)” on [page 170](#).

*NOTE: If your SNAP-PAC R-series controller cannot communicate via the host port after attempting to update firmware, see [KB82101, Updating to firmware 9.2c or higher may fail on SNAP-PAC-R controllers, on the Opto 22 website](#).*

If you see the button, click it and read the diagnostic messages. They may help you solve problems or provide useful information when you call Product Support.

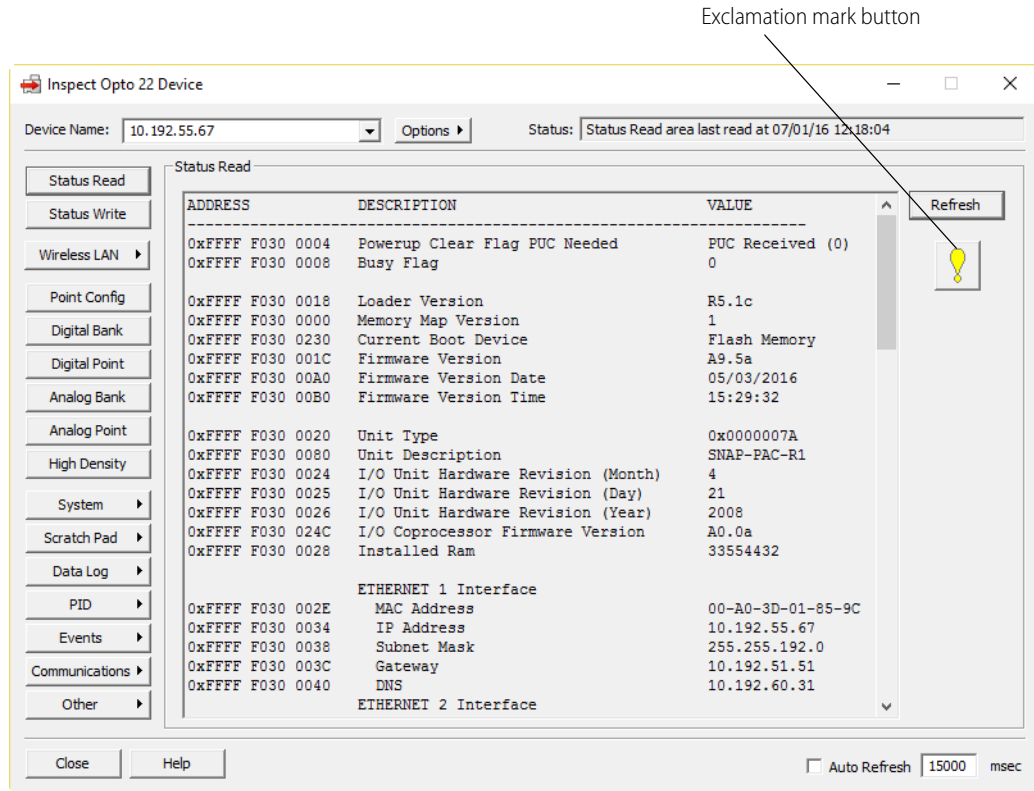

PAC-S  
PAC-R  
SoftP  
EB  
UIO  
EIO  
SIO  
E1  
E2

### Getting Device and Firmware Information—Multiple Devices

You can get device type, IP address, and firmware information for all Opto 22 Ethernet-based devices on one network, all at one time. This method is especially useful for making sure firmware is up to date on all devices. Note that SNAP PAC SB brains are not included, since they are on a serial, not an Ethernet, network.

1. If PAC Manager isn't already open, start it. (For instructions, see the footnote on [page 16](#).)

- In the PAC Manager menu bar, click Tools > Find Opto 22 MMP Devices.

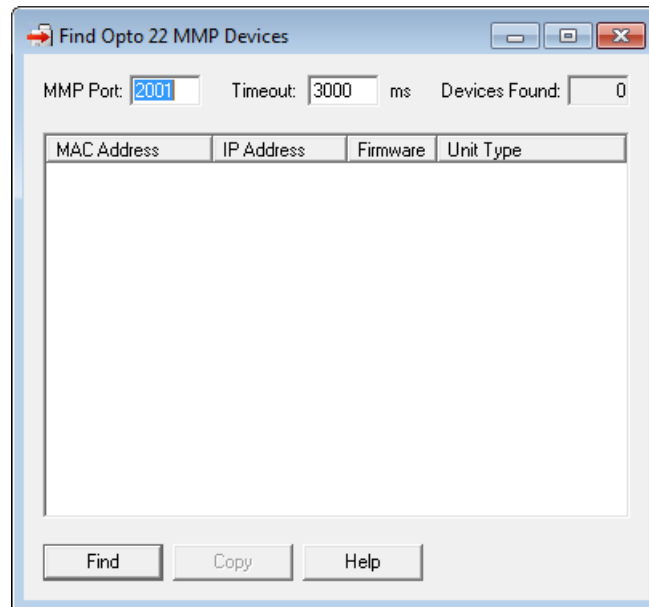

- Click Find.

PAC Manager discovers all Ethernet-based Opto 22 memory-mapped devices on the network and lists their MAC addresses, IP addresses, firmware versions, and unit types.

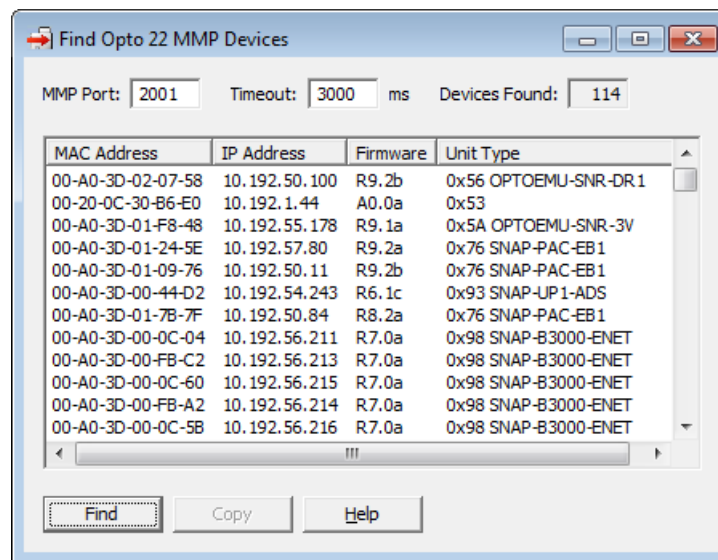

PAC-S  
PAC-R  
SoftP  
EB  
UIO  
EIO  
SIO

### TCP Settings

(Does not apply to SB brains. Does not apply to E1 I/O or E2 I/O units with E1/E2 firmware R1.1f or lower.)

Retransmit timeout (RTO) refers to the length of time the controller or brain waits while communicating before timing out. The RTO is determined by the controller or brain's TCP/IP stack, and the stack continually recalculates the RTO based on recent network traffic. If the network becomes busier, for example, the stack automatically adjusts the RTO to a higher value.

If the TCP/IP stack times out while trying to transmit data, it doubles the current RTO and tries again. This process continues for five retries; after that, the device stops trying and sends a timeout message.

If you are receiving frequent timeout messages from the device, you can change the TCP parameters in PAC Manager.

1. Start PAC Manager:
  - In Windows 7, click the Windows Start button, and then click All Programs > Opto 22 > PAC Project 10.4 > PAC Manager 10.4.
  - In Windows 10, click the Windows Start button and type Opto 22 > PAC Manager 10.4.
2. In the PAC Manager main window, click the Inspect icon .
3. In the Device Name field, type the name or IP address of the controller or I/O unit. Then, click Status Write.

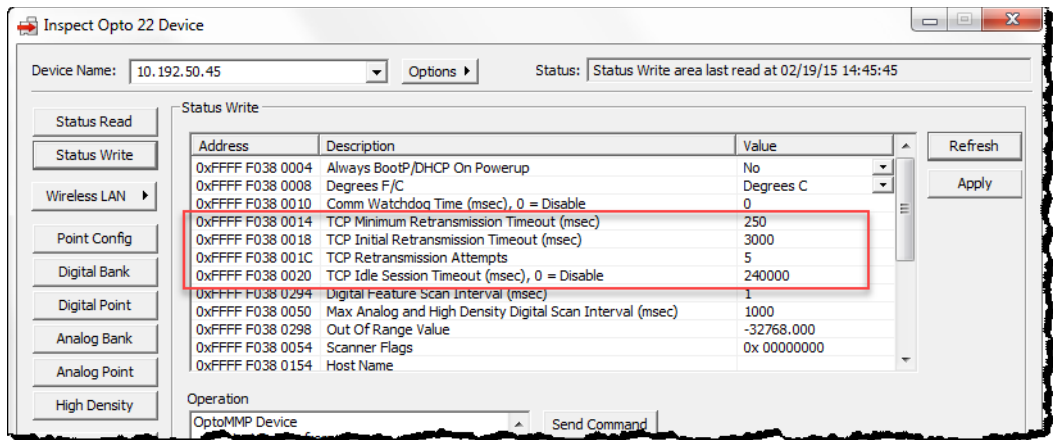

**CAUTION:** Note the following recommended settings:

TCP Minimum Retransmission Timeout (msec):	250
TCP Initial Retransmission Timeout (msec):	3000
TCP Retransmission Attempts:	5
TCP Idle Session Timeout (msec):	240,000

If you set these fields too low, you may not be able to communicate with the device at all—even through PAC Manager—to fix the settings. Then you would have to reset the controller or I/O unit to factory defaults.

4. Change these four fields as necessary:
  - Minimum RTO** sets an absolute minimum value for the RTO. The device’s calculated RTO will never go below this value.
  - Initial RTO** sets the RTO for the first communication try. Be careful: since all future tries are based on this value, if you set it too low for network conditions, a connection will never be made.
  - TCP Retransmits** sets the number of times the device retries communication. Larger, busier networks need a higher number of retransmits than smaller networks with less traffic.
  - TCP idle session timeout** sets how long (in milliseconds) the device allows a session to remain open without any activity. After this time, the device checks the session to make sure it is still good, and closes it if it is not. The default is 240,000 milliseconds, or four minutes.
5. Click the Apply button to write your changes to the controller or I/O unit.
6. In the Operation Commands list, highlight Store configuration to flash. Click Send Command.
7. In the Operation Commands list, highlight Restart brain from powerup. Click Send Command.

The new TCP parameters are set.

PAC-S  
PAC-R  
EB  
UIO  
EIO  
SIO

## Checking Ethernet Errors

*NOTE: Does not apply to E1 and E2 I/O units with E1/E2 firmware R1.1f or lower.*

If you are having problems communicating with the controller or I/O unit, follow troubleshooting suggestions in the user's guide for the device.

You can use PAC Manager to check Ethernet errors reported by the SNAP PAC device. These errors indicate network problems. You will need to know the device's IP address.

1. If PAC Manager isn't already open, start it. (For instructions, see the footnote on [page 16](#).)
2. In the PAC Manager main window, click the Inspect button .
3. In the Device Name field, type the name (or IP address) of the controller or I/O unit. Click Status Read.
4. Scroll down until you see these items:

Ethernet Errors: Late Collisions  
Ethernet Errors: Excessive Collisions  
Ethernet Errors: Others

Ethernet Errors

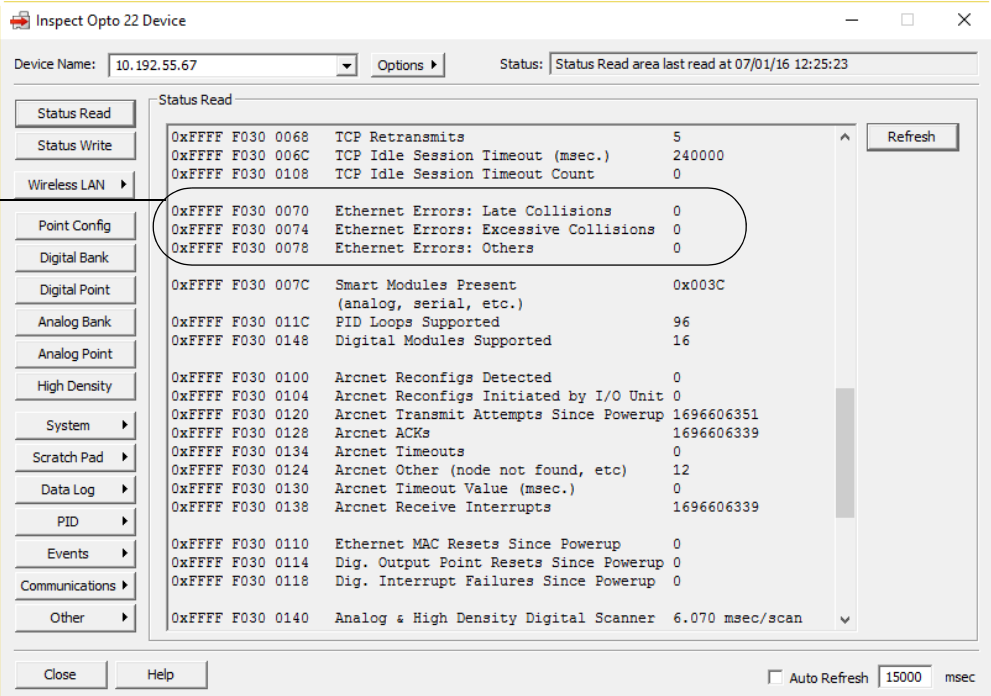

Address	Parameter Name	Value
0xFFFF F030 0068	TCP Retransmits	5
0xFFFF F030 006C	TCP Idle Session Timeout (msec.)	240000
0xFFFF F030 0108	TCP Idle Session Timeout Count	0
0xFFFF F030 0070	Ethernet Errors: Late Collisions	0
0xFFFF F030 0074	Ethernet Errors: Excessive Collisions	0
0xFFFF F030 0078	Ethernet Errors: Others	0
0xFFFF F030 007C	Smart Modules Present (analog, serial, etc.)	0x003C
0xFFFF F030 011C	PID Loops Supported	96
0xFFFF F030 0148	Digital Modules Supported	16
0xFFFF F030 0100	Arcnet Reconfigs Detected	0
0xFFFF F030 0104	Arcnet Reconfigs Initiated by I/O Unit	0
0xFFFF F030 0120	Arcnet Transmit Attempts Since Powerup	1696606351
0xFFFF F030 0128	Arcnet ACKs	1696606339
0xFFFF F030 0134	Arcnet Timeouts	0
0xFFFF F030 0124	Arcnet Other (node not found, etc)	12
0xFFFF F030 0130	Arcnet Timeout Value (msec.)	0
0xFFFF F030 0138	Arcnet Receive Interrupts	1696606339
0xFFFF F030 0110	Ethernet MAC Resets Since Powerup	0
0xFFFF F030 0114	Dig. Output Point Resets Since Powerup	0
0xFFFF F030 0118	Dig. Interrupt Failures Since Powerup	0
0xFFFF F030 0140	Analog & High Density Digital Scanner	6.070 msec/scan

All three of these items should have a value of zero. If any of these items has a value other than zero, you may have a network problem.

PAC-S  
PAC-R

## Troubleshooting Serial Communication

If you need to troubleshoot serial communication over PPP, you can turn on logging for the port the modem uses. Any data received or transmitted on the port is logged to a file on the controller, which you can retrieve using FTP and analyze for problems.

You can also log communication with a serial device or I/O unit for troubleshooting, but since the log file logs serial data sent only between PAC Control and the serial device or I/O unit, it is easier to log communication in your PAC Control strategy in these cases.

*CAUTION: Logging adds significant overhead to serial communication. Do not enable logging unless you are troubleshooting.*

**Creating the Log File**

1. In the PAC Manager main window, click the Inspect button .
  2. In the Device Name field, type the name (or IP address) of the controller (or choose it from the drop-down list).
  3. Click Communications and choose Communication Port Control from the submenu.
- The Inspect window shows the ports and features that apply to the controller you’re inspecting.

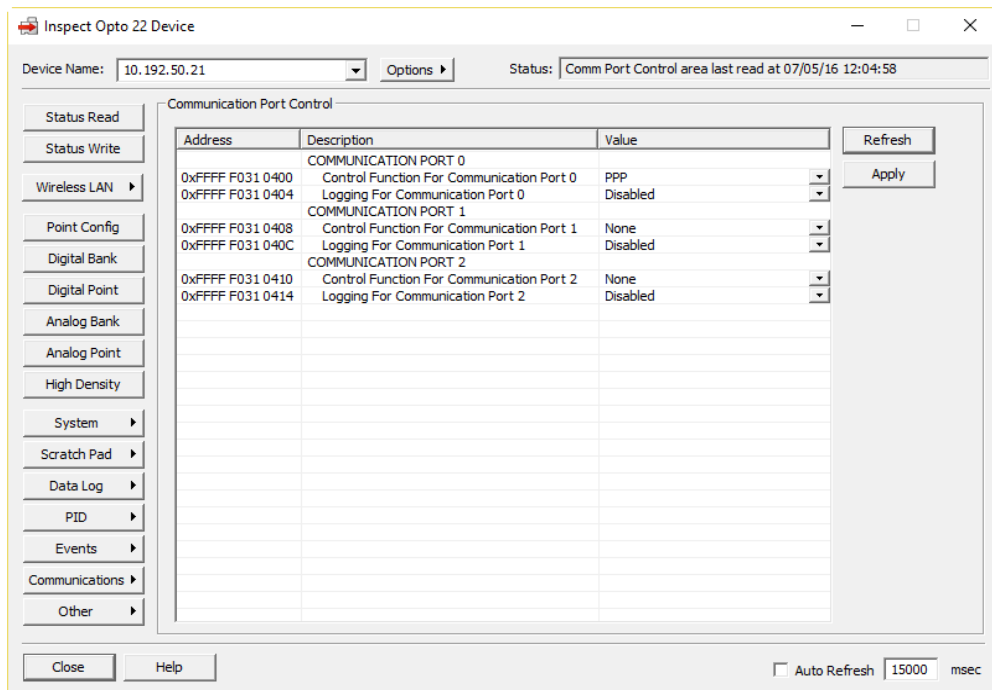

4. Find the port you’re troubleshooting. In its Logging For Communication Port # field, click Disabled and change it to Enabled.  
Logging begins immediately.

**Retrieving the Log File**

1. Before retrieving the log file, go back to the PAC Manager Inspect window and set Logging For Communication Port # back to Disabled (see steps in the previous section).  
When you disable logging, all data is flushed to the file.
2. Use an FTP client to retrieve the log file, which is located in the root directory of the controller’s file system and named Comm<x>.log (where <x> is the physical serial port number).  
See [“Maintaining Files” on page 239](#) for information on FTP clients, and [“Moving Files from the SNAP Controller or I/O Unit” on page 243](#) for how to retrieve the file.

**Reading the Log File**

In the log file, full duplex serial communication is transformed into a single stream using these rules:



- Data bytes are not transformed in any way. The binary data byte is logged.
- A direction byte is prepended to every data byte: 0 = outgoing, 1 = incoming.
- The data stream is terminated by a null character (ASCII 0x00).

The maximum log file size is 16 kb. When it reaches the end, the log stream wraps to the beginning of the file. To locate the oldest data in a wrapped file, search for a null character in place of a 1 or 0; since the null terminates the log data stream, the next logged data byte is the oldest data byte in the file. If the null character is at the end of the file, the file has not wrapped.

## Troubleshooting Wireless LAN Communication

If you are having difficulty with wireless LAN communication on a Wired+Wireless controller or brain (part number ending in -W), Opto 22 Product Support may ask you to log WLAN data.

1. (SNAP PAC controllers only) Make sure there is a microSD card to receive the log file.  
If no card is in the microSD slot, no log file is created. (A card is not required for a SNAP PAC EB-W brain, which has no card slot.)
2. In the PAC Manager main window, click the Inspect button .
3. In the Inspect window's Device Name field, type the name (or IP address) of the controller (or choose it from the drop-down list).
4. Click Wireless LAN and choose Wireless LAN Configure.
5. Change the WLAN Logging value as Product Support directs.
6. Enter the Network Key.
7. Click Apply. When asked to restart the device, click Yes.

The log is always written to the same file; path and filename on both controllers and brains is:  
/sdcard0/ATH0.LOG

If the file already exists, new data is appended to the end of it.

The log file looks similar to this:

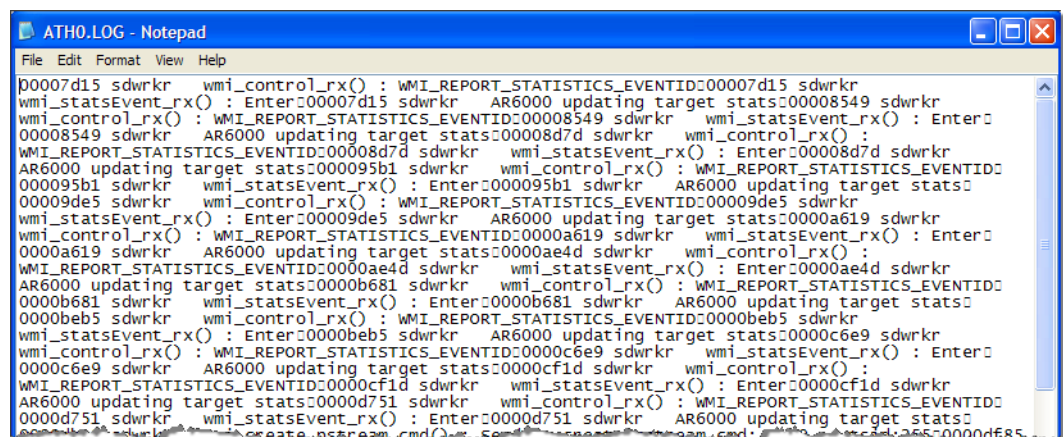

```

00007d15 sdwrkr wmi_control_rx() : WMI_REPORT_STATISTICS_EVENTID=00007d15 sdwrkr
wmi_statsEvent_rx() : Enter=00007d15 sdwrkr AR6000 updating target stats=00008549 sdwrkr
wmi_control_rx() : WMI_REPORT_STATISTICS_EVENTID=00008549 sdwrkr wmi_statsEvent_rx() : Enter=
00008549 sdwrkr AR6000 updating target stats=00008d7d sdwrkr wmi_control_rx() :
WMI_REPORT_STATISTICS_EVENTID=00008d7d sdwrkr wmi_statsEvent_rx() : Enter=00008d7d sdwrkr
AR6000 updating target stats=000095b1 sdwrkr wmi_control_rx() : WMI_REPORT_STATISTICS_EVENTID=
000095b1 sdwrkr wmi_statsEvent_rx() : Enter=000095b1 sdwrkr AR6000 updating target stats=
00009de5 sdwrkr wmi_control_rx() : WMI_REPORT_STATISTICS_EVENTID=00009de5 sdwrkr
wmi_statsEvent_rx() : Enter=00009de5 sdwrkr AR6000 updating target stats=0000a619 sdwrkr
wmi_control_rx() : WMI_REPORT_STATISTICS_EVENTID=0000a619 sdwrkr wmi_statsEvent_rx() : Enter=
0000a619 sdwrkr AR6000 updating target stats=0000ae4d sdwrkr wmi_control_rx() :
WMI_REPORT_STATISTICS_EVENTID=0000ae4d sdwrkr wmi_statsEvent_rx() : Enter=0000ae4d sdwrkr
AR6000 updating target stats=0000b681 sdwrkr wmi_control_rx() : WMI_REPORT_STATISTICS_EVENTID=
0000b681 sdwrkr wmi_statsEvent_rx() : Enter=0000b681 sdwrkr AR6000 updating target stats=
0000beb5 sdwrkr wmi_control_rx() : WMI_REPORT_STATISTICS_EVENTID=0000beb5 sdwrkr
wmi_statsEvent_rx() : Enter=0000beb5 sdwrkr AR6000 updating target stats=0000c6e9 sdwrkr
wmi_control_rx() : WMI_REPORT_STATISTICS_EVENTID=0000c6e9 sdwrkr wmi_statsEvent_rx() : Enter=
0000c6e9 sdwrkr AR6000 updating target stats=0000cf1d sdwrkr wmi_control_rx() :
WMI_REPORT_STATISTICS_EVENTID=0000cf1d sdwrkr wmi_statsEvent_rx() : Enter=0000cf1d sdwrkr
AR6000 updating target stats=0000d751 sdwrkr wmi_control_rx() : WMI_REPORT_STATISTICS_EVENTID=
0000d751 sdwrkr wmi_statsEvent_rx() : Enter=0000d751 sdwrkr AR6000 updating target stats=
0000d751 sdwrkr wmi_statsEvent_rx() : Enter=0000d751 sdwrkr AR6000 updating target stats=
0000d751 sdwrkr create_psrfram_cmd() : Enter=0000d751 sdwrkr AR6000 updating target stats=
0000d751 sdwrkr

```

Product Support will interpret the log file.



# A: Menus

## FILE MENU

**New.** Displays the Create New Tag Database dialog, allowing you to specify the name and location of a new tag database. If changes to the current configuration have not been saved, you will be asked if you wish to save those changes before proceeding. Only one configuration may be open at a time.

**Open.** Displays the Open Tag Database dialog, allowing you to open a previously created tag database. If changes to the current configuration have not been saved, you will be asked if you wish to save those changes before proceeding. Note that only one configuration may be open at a time.

**Close.** Closes the current configuration. If changes to the configuration have not been saved, you will be asked if you wish to save those changes.

**Save.** Displays the Save Tag Database dialog, allowing you to save your configuration to disk.

**Save As.** Displays the Save Tag Database As dialog, allowing you to define a new name and/or location for the current configuration.

**(Recent Tag Databases).** The four most recently opened Tag Databases are listed below Save As on the File menu. Selecting any of them is equivalent to choosing Open Tag Database from the File menu and entering the tag database name.

**Exit.** Closes the current configuration file and exits PAC Manager. If changes to the current configuration have not been saved, you will be asked if you wish to save those changes before exiting PAC Manager.

## EDIT MENU

**Cut.** Has no current functionality.

**Copy.** Available when an I/O Unit is highlighted in the tree view. When selected, the highlighted I/O Unit will be copied to the clipboard.

**Paste.** Pastes an I/O Unit from the clipboard into the strategy tree. This item is enabled only when an I/O Unit has been previously copied to the clipboard.

## TOOLS MENU

Select menu items in the Tools menu to inspect and manage SNAP PAC controllers and brains, including configuring IP addresses, installing firmware, and exchanging files.

**Send Configuration to I/O Unit.** After you have finished configuring I/O units and saved the configuration file, you must load the configuration file into the I/O unit's memory. This menu item opens the [Send Configuration To I/O Unit](#) dialog box.

**Inspect.** Opens the [Inspect Opto 22 Device](#) window. Select this menu item to view and change I/O and other configuration settings for a specific SNAP PAC controller or brain.

*IMPORTANT: Configuration changes made to the I/O Unit in the Inspect window are not saved in the PAC Manager configuration file.*

**Maintenance.** Displays the I/O Unit Maintenance window. Select this menu item to upgrade firmware, exchange files, and manage items in flash memory.

**Assign IP Address.** Displays the [Assign IP Address](#) dialog. Select this menu item to see all Opto 22 Ethernet devices that are broadcasting DHCP or BootP requests. You can then assign IP addresses to these devices and test the addresses to confirm proper communication.

**Change IP Settings.** Displays the Change IP Settings dialog box. Select this menu item to change the IP address and related network settings on a SNAP PAC controller or brain.

**Install Firmware via Ethernet.** Opens the Maintenance dialog box, which is used to download new firmware to SNAP PAC controllers and brains.

**Install Firmware via Serial Connection.** Launches the application OptoFlash-ENET, which is used to download new firmware to SNAP Ethernet and SNAP Simple brains via a serial connection. See the online help included with OptoFlash-ENET for more information.

**Install Firmware via Failsafe Bootloader Mode.** Provides a way to install firmware when the firmware in the device is damaged. See ["Replacing Damaged Firmware" on page 236](#).

**Import/Copy I/O Unit.** Displays the [Inspect Opto 22 Device](#) window. This dialog enables you to save an I/O unit's flash memory image to a file on your hard disk. This image file can then be used to configure another I/O unit. Configuration information can also be read directly from an I/O unit and sent directly to another I/O unit, or imported into PAC Manager to create a new I/O unit configuration that can be expanded upon.

**Modbus Calculator.** Converts an I/O unit memory map address to a Modbus Unit ID and Register Address. See ["Determining Modbus Unit ID and Register Address" on page 130](#).

**Find Opto 22 MMP Devices.** Displays a dialog box you can use to find the MAC and IP addresses (see ["Find Opto 22 MMP Devices" on page 282](#)) of all Opto 22 memory-mapped devices on the Ethernet network.

## VIEW MENU

**Toolbar.** Toggles the display of the toolbar.

**Status Bar.** Toggles the display of the Status Bar.

## HELP MENU

**Help Topics.** Opens the PAC Manager Help file's index of topics.

**Manuals.** Provides the PAC Manager User's Guides in PDF format.

**Opto 22 on the Web.** Provides links to downloads, product support, and the Opto 22 website.

**About PAC Manager.** Provides general information about PAC Manager, including the version number and copyright information.



# B: Dialog Boxes

## ADD/EDIT ANALOG POINT

Use this dialog box to add analog points or edit the configuration of existing analog points.

**Name.** Type in a name for the I/O point. The name must start with a letter and may contain letters, numbers, and underscores (spaces are converted to underscores).

**Description (optional).** Enter a description of the point.

**Type.** When the channel can be configured as either an input or an output, select the type from the drop-down list.

**Module.** Select the I/O module or point type from the drop-down list. All available modules of the type specified will be included.

**Units.** Each analog module has a default set of units. These units are displayed in this field. If you assign custom units to the module (by clicking the Custom button), the custom units will appear here instead.

**Zero Scale.** The module's default zero-scale value appears here. This can be changed to a custom value (by clicking the Custom button).

**Full Scale.** The module's default full-scale value appears here. This can be changed to a custom value (by clicking the Custom button).

**Default button.** Click here to return the units, zero-scale value, and full-scale value to the defaults for the module. This is useful if you have assigned custom units and values through the Custom button that you now wish to ignore.

**Custom button.** Click here to display the [Scale Analog Readings](#) to assign custom units, zero-scale, and/or full-scale values to the module. For example, you could change the voltage range of a 0–10 VDC module to be interpreted instead as a pressure range of 20–200 psia.

**Watchdog.** Click No (the default) to disable a watchdog on this point, or click Yes to enable the watchdog (available for outputs only). If you select Yes, a new field will appear to allow you to define the value to be assigned to the output should the watchdog be triggered. Enter a value between the zero-scale and full-scale values (described above).

A watchdog is triggered if no communication activity is detected on the bus for the amount of time specified in the Watchdog field of this point's I/O unit.

## ADD/EDIT DIGITAL POINT

Use this dialog box to configure a digital point for an I/O unit.

**Name.** Type in a name for the I/O point. The name must start with a letter and may contain letters, numbers, and underscores (spaces are converted to underscores).

**Description (optional).** Enter a description of the point.

**Type.** When the channel can be configured as either an input or an output, select the type from the drop-down list.

**Module.** Select the I/O module or point type from the drop-down list. All available modules of the type specified will be included.

**Features.** Click here to view and select from the available features for the I/O point you are configuring. Features are available only if you are adding a point to a multifunction I/O unit. By default no feature is selected.

For inputs, depending on the module *and* I/O unit, you may be able to configure the module as a counter, on-pulse, off-pulse, frequency, period, on-time totalizer, off-time totalizer, or quadrature counter feature. You may be able to configure an output module as a time-proportional output (TPO).

**Watchdog.** This field, which appears only if you enable the watchdog, also has only two values. Click the field and select On or Off from the drop-down list. Remember, watchdogs are available only for output modules.

## ADD/EDIT EVENT MESSAGE

Use this dialog box to add a new event message or edit an existing event message.

**Message Name.** Type in a descriptive name for this event message. The message name is not sent to the I/O Unit. It is used only within PAC Manager to differentiate event messages from one another.

**Message Text.** For e-mail, serial, and SNMP event messages, type in the text to be sent as the message. For MemMap Copying, this field holds the Source Memory Map address or the Source Data. Plugins can be used in the message text. The text limit is 127 characters.

**Streaming.** To have the I/O Unit periodically stream data back to a PC, select Enabled from the drop-down list. You must first use [Configure Streaming](#) to set the host(s) to receive the streamed data.

**Period (sec).** Enter the interval in seconds at which streaming should take place. A value of 0 means that data will be streamed only once.

**E-mail.** To have the I/O Unit send the Message Text using e-mail, select Enabled from the drop-down list. You must first use [Configure E-mail](#) to set the e-mail address that will receive the Message Text.

**Period (sec).** Enter the interval in seconds at which the e-mail should be sent. A value of 0 means that the e-mail message will be sent only once.

**Serial Module.** To have the I/O Unit send the Message Text as a string through a serial communication module, select Enabled or Disabled from the drop-down list and enter the string to send in the Message Text area. You must first use [Configure Serial Modules](#) to set serial modules and their ports.

**Serial Ports Mask.** Enter a mask representing the serial modules and ports to send the message through. Bits 0-31 correspond to ports 0-31.



**SNMP Trap.** To have the I/O Unit send the Message Text as an SNMP trap, select Enabled from the drop-down list. You must first use Configure SNMP Agent to set up SNMP system variables, community groups, and management hosts.

**Period (sec).** Enter the interval in seconds at which to send the SNMP trap. A value of 0 means that the trap will be sent only once.

**Trap Type.** Enter the trap type required by your SNMP management software. Refer to the documentation for your SNMP management software for information on determining the required SNMP trap type.

**Priority.** If you are using SNMP with an outgoing PPP (modem) connection and want the SNMP trap stored in the I/O Unit until the next communication, set Priority to Low. If you want the I/O Unit to immediately dial out and send the trap, set Priority to High.

**MemMap Copy Destination.** To change the state of a digital point on a different I/O Unit, or to copy data from one memory map address to another, select Enabled from the drop-down list and complete the MemMap Address, IP Address, Period (msec), and IP Port fields for the location the data is being copied *to*. In the Message Text area, enter the source data or memory map location data is being copied *from*.

**MemMap Address.** Enter the destination memory map address in hexadecimal. You do not have to include the leading FFFF.

**Period (msec).** Enter the interval in milliseconds at which the MemMap copy should take place. A value of 0 means that the copy will be done only once.

**IP Address.** Enter the IP address of the destination I/O Unit. Use 0.0.0.0 if copying to an address on the same I/O Unit.

**IP Port.** Enter the IP port of the destination I/O Unit. This field is ignored if copying to the same I/O Unit.

## ADD/EDIT I/O UNIT

Use this dialog box to add a new I/O Unit or edit an existing I/O Unit.

1. Enter a **name** for the I/O unit. The name must start with a letter and may contain letters, numbers, and underscores. Spaces are converted to underscores.
2. (Optional) Enter a **description** of the unit.
3. Select the **type** of I/O unit from the drop-down list.
4. Choose whether **temperatures** will be handled in Fahrenheit or Celsius.
5. Specify the communication **port** to use (2001, unless you have changed it for security purposes).
6. Enter the I/O unit's **IP address**.
7. The **Address List** area shows IP addresses of the I/O units that should receive this configuration. If you have I/O units that are exactly alike, list all of them here. That way you can download the configuration file to all the I/O units at once. To list them, click Add and enter a single IP address or a range of addresses.
8. Select whether you want a **Watchdog** on the unit. The default is No (disabled). If you select Yes, a new field appears; enter the Watchdog timeout value in seconds. The default timeout is 0.5 seconds.

When a watchdog is enabled, the I/O unit monitors activity on the port. If no communication is received for the specified interval, the unit automatically sets designated digital and analog I/O points to values you have set in the Watchdog field of the [Add/Edit Analog Point](#) or [Add/Edit Digital Point](#).

## ADD/EDIT IP ADDRESS

Use this dialog box to add an IP Address or a range of IP Addresses that will all receive this I/O unit configuration. Usually these are I/O units that are exactly alike. Also use this dialog box to modify a single IP address.

## ADD/EDIT MEMORY MAP VALUES

1. Click either Add one IP Address or Add a range of IP Addresses.
2. For a single IP address, enter or change the address and click OK.
3. To add a range of IP addresses, enter the first address in the range in the From field. Enter the last IP address in the To field. Then click OK.

## ADD/EDIT MEMORY MAP VALUES

Use this dialog box to add a new Memory Map Value or edit an existing Memory Map Value.

**Address.** Type in a valid Memory Map Address. The address must be in hexadecimal and correspond to a valid write area in the device's Memory Map. Use the [OptoMMP Protocol Guide](#) (form 1465) as a reference.

**Value.** Type in the value to send to the above address. The value may be in hexadecimal (integer types only) or decimal. For hex, precede the value with 0x. (Based on this convention, PAC Manager will remember if your value is in hex or decimal.)

**Type.** Select the type of Memory Map Value.

## ADD/EDIT PID LOOPS

Use this dialog box to add or change PID loops on SNAP PAC brains, and R-series controllers. You can configure up to 96 PID loops. Four algorithms are available to choose from.

See also ["Configuring PID Loops" on page 78](#).

1. Enter a unique, descriptive **name** for the PID.
2. (Optional) Enter a **description** of the PID.
3. Select the type of **input**: I/O Point, Host, or PID Output.
  - If the PID's process variable comes from an I/O point on the same unit, select I/O Point. Choose the point from the drop-down list or type a point name to configure a new point.
  - If the PID's process variable comes from a PAC Control strategy, select Host. Enter an initial value for the input.
  - If the PID's process variable is the output of another PID on this brain (a cascading control loop), select PID Output. Choose the PID from the drop-down list.
4. (Optional) If you chose I/O Point or PID, check the **Square Root** box if the error should be calculated based on the square root of the process variable (applies to flow control systems where volumetric flow is proportional to the square root of a signal from a flow transducer).
5. Set the valid range of the process variable by entering the **low range** and the **high range**. (See below for optional responses to out-of-range input.)
6. Choose the source for the **setpoint**: I/O Point, Host, or PID Output.
  - To control the setpoint using a device such as a potentiometer, select I/O Point; choose an I/O point from the drop-down list or type a new point name.
  - To control setpoint using PAC Control or PAC Display, select Host and enter an initial value.
  - If another PID loop will control the setpoint, select PID Output and choose the PID from the drop-down list.
7. Choose the destination for the PID **output**: I/O Point or Host. (To use the output for controlling the setpoint or input of another PID, choose Host.)
8. Enter upper and lower clamp values to prevent the output from exceeding a desirable range. These values should equal the range of the output point, if used. Or choose values to make sure that the output device doesn't shut off (for example, keeping a circulation pump running regardless of the PID output) or

that the output never reaches a destructively high setting (for example, keeping a motor below maximum).

9. (Optional) Enter **minimum and maximum change** values. The output won't respond until the minimum change is reached (for example, you may not want a heater to turn on to correct a 1 degree error). Maximum change prevents too drastic a change in output (for example, you could limit the increase in a pump's output to prevent pipe breakage). The default for both minimum and maximum is zero, which disables the feature.
10. Choose how the PID should respond (**output options**) if the input goes out of range. If no boxes are checked, the PID will freeze output at the current value. To have PAC Control logic or an operator respond, check Switch to manual mode. To force the output to a specific value, check Force output and type the output values. *NOTE: If both boxes are checked (forced output and manual mode), the output will be forced and the PID put into manual mode; but if the PID is already in manual mode, the output will not be forced.*
11. Choose **algorithm**: Velocity, ISA, Parallel, Interacting. See also "[Algorithm Choices](#)" on page 79.
12. Choose **mode**. Auto activates the PID. Manual requires that PAC Control logic or an operator control the PID output.
13. Enter a **scan rate** to determine how often the input is scanned and the controller output is calculated. Minimum value is 0.001 (1 millisecond). Scan time should be greater than system lag (the time it takes for the controller output to have a measurable effect on the system). Also consider other PIDs and tasks on the brain competing for processing power.
14. Enter a positive or negative value for **Gain**. Heating systems usually require a negative value and cooling systems a positive value. *NOTE: Gain is usually refined during the tuning process.*
15. (Optional) Enter **Feed Forward Initial** and **Feed Forward Gain** values if you need to offset the controller output in your application. These values are constants that are multiplied and added to the controller output; often they are not used in PIDs.
16. (Optional) Enter Integral (**Tune I**) and Derivative (**Tune D**) settings if you know the desirable settings. However, Integral and Derivative are not essential to basic configuration and are better determined in the tuning process.
17. Click **OK**.

## ADD/MODIFY NEW DEVICE

To add a new I/O Unit Name, click Options to open the Add New Device dialog box.

**Device Name:** Enter a name for the I/O unit. You can use the IP address or any unique name. Change the timeout if necessary.

**Direct Connection to Ethernet Device:** Use this option if there is a direct connection to the brain via an Ethernet cable.

- *IP Address or Hostname:* Enter the IP address or hostname of an Ethernet I/O unit, such as a PAC EB-series or PAC R-series device.
- *Ethernet Port:* Use the default of 2001 for Ethernet Port unless you have changed the port.

**Direct Connection to Serial Device:** Use this option if the I/O unit is connected directly to the PC using a serial cable and a PCI-AC48 adapter card.

- *PC Serial Port:* Enter the serial port on the PC where the brain is connected.
- *PC Baud Rate:* The baud rate on the PC must match the rate set on the brain.
- *Serial Device Address:* Enter the serial address of the brain.

**Pass-Through Ethernet Controller to Serial Device:** Use this option for SNAP-PAC-SB1 and SB2 brains connected to a SNAP-PAC-S1 or S2 controller.

- *IP Address or Hostname:* Enter the IP address or hostname of the S-series controller.

## ASSIGN IP ADDRESS

- *Ethernet Port:* Use the default of 2001 for Ethernet Port unless you have changed it.
- *Controller Serial Port:* Enter the controller's serial port where the brain is connected. On a SNAP-PAC-S1, it's Serial 2. On a SNAP-PAC-S2, it could be any port.
- *Controller Baud Rate:* The baud rate on the controller must match the rate set on the brain.
- *Serial Device Address:* Enter the serial address of the brain.
- *2-Wire RS-485:* Check this box for a 2-wire RS-485 connection. SNAP-PAC-S1 controllers support only 2-wire RS-485. SNAP-PAC-S2 controllers support 2-wire or 4-wire RS-485.

## ASSIGN IP ADDRESS

Use this dialog box to assign IP addresses to Opto 22 devices, either by listening for devices sending DHCP or BootP broadcasts, or by first creating a list of mappings.

*NOTE: In order to assign IP addresses, you must be logged in with administrative rights.*

See also ["Assigning an IP Address" on page 15](#).

Each device ships from the factory with a unique MAC address (printed on a label on the device) and a default IP address of 0.0.0.0, which is invalid. SNAP PAC, SNAP-LCE, SNAP Ultimate, SNAP Ethernet, and SNAP Simple I/O send out a BootP broadcast when first turned on. E1s and E2s send out a DHCP broadcast. In most cases, you must give each of these devices a fixed, static IP address. See also ["Assigning IP Addresses to SNAP PAC, UIO, EIO, and SIO" on page 15](#) and ["Assigning IP Addresses to E1 and E2 I/O Units" on page 21](#).

### Assigning IP Addresses to SNAP PAC, UIO, EIO, SIO, and LCE

If your network has a DHCP server, either assign a static IP address before connecting the device to the network (preferred), or disable the server. Note the MAC address of each device that needs an IP address, and turn on the device(s).

*NOTE: SNAP PACs each have two separate Ethernet network interfaces. Each interface has a separate MAC address and therefore takes a separate IP address. Only ENET1 sends a BootP request. Once you have assigned this primary IP address, you can assign the secondary address using the [Inspect Opto 22 Device](#) window.*

1. Double-click the MAC address of the device in the upper list.
2. In the Mapping dialog box, enter the IP Address and Subnet Mask for the device. If it will be talking to a device on another subnet, enter the Gateway (router) address. If it will talk only on the local subnet, leave the gateway address all zeros (0.0.0.0). Leave the DNS address at 0.0.0.0 and the Host Name field blank. Click OK.
3. The new IP address information appears in the upper list in the dialog box, and the device's status changes to Mapped. The address information also appears in the lower list to show that this device has been mapped to this address.
4. With the device still highlighted, click Assign. The address is saved to flash memory and the status changes to Static IP. To verify that the IP address has been successfully assigned, highlight the device in the upper list and click Test. A DOS window opens and the IP address is pinged.
5. For future reference, write the IP address next to the MAC address on the white sticker provided on the device.
6. To save the list of IP address and MAC address mappings (the lower list in the dialog box), click Save List.

*NOTE: If you have a large number of devices or are on a separate network, you can create the mappings list first, save it, and then load it into PAC Manager later. Devices that match the mappings receive their IP addresses as soon as they appear in the upper list. Click Assign All to save them.*

### Assigning IP Addresses to E1 and E2 I/O Units

1. Note the MAC address of the E1 or E2, and turn on the E1 or E2 I/O unit. The I/O unit sends a DHCP broadcast. The broadcast is usually answered by a DHCP server on the network, and the server assigns a dynamic IP address.
2. On a PC on the same network, open a Command Prompt. Type ping and the host name of the I/O unit. The default host name for any E1 or E2 is OPTO- followed by the last six digits of the brain board's MAC address. For example, for an E1 with a MAC address of 00-a0-3d-00-09-35, you would type: `ping OPTO-00-09-35`
3. If the ping command worked, write down the IP address from the ping reply. Continue with the next step.

*CAUTION: You may have problems continuing with the next step if your network includes old Opto 22 SNAP Ethernet brains with firmware version R1.3m or earlier, or controllers with M4SENET-100 adapter cards at firmware version R1.3k or earlier. These brains and adapter cards may have to be rebooted if you use the discovery feature in the next steps.*

*To avoid this problem, either update the older devices to newer firmware before continuing, or ask your network administrator to provide you with the dynamic IP address currently assigned to the E1 or E2, and then skip to ["Changing the IP Address to a Static IP"](#) on page 23.*

4. If the ping command did not return a reply: Choose Tools-->Find Opto 22 MMP Devices. In the dialog box, click Find. PAC Manager discovers all Opto 22 memory-mapped devices on the network. Write down the device's IP address. Close the dialog box.

*NOTE: If the E1 or E2 is not in the list, there is no active DHCP server on the network and therefore the device does not have an IP address. Follow the steps outlined above for Assigning IP Addresses to SNAP PAC, UIO, EIO, SIO and LCE, except before pinging the device, click Set Static IP to save the IP address to flash memory.*

## ASSIGN SECONDARY IP ADDRESS

SNAP PAC controllers each have two, independent Ethernet network interfaces. With PAC Project Professional, you can use these interfaces to segment the control network from the company network or for Ethernet link redundancy. For more information, see the [PAC Control User's Guide](#) (form 1700), the [PAC Display User's Guide](#) (form 1702) and the [OptoOPCServer User's Guide](#) (form 1439, available with the purchase of PAC Project Professional or OptoOPCServer).

*IMPORTANT: The two Ethernet interfaces will work only if they are on separate network segments, so the control engine can clearly determine where to direct communication. For example:*

	ENET1	ENET2
IP Address:	192.168.0.12	10.0.0.5
Subnet Mask:	255.255.255.0	255.255.255.0

The first Ethernet interface, ENET1, sends a BootP broadcast and is assigned an IP address just like other Opto 22 devices (see ["Assign IP Address"](#) on page 266).

**To assign an IP address to ENET2**, follow these steps:

1. Make sure that ENET1 has already received an IP address.
2. In the PAC Manager main window, click the Inspect button.
3. In the Inspect window, enter the IP address for ENET1 and click Status Read. Status information for the controller appears in the window. If the secondary IP address has not been assigned yet, the secondary IP address information will show all zeros.
4. Click Status Write. Enter the IP address information for ENET2 in the Value column in the Secondary IP Address, Secondary Subnet Mask, and (if necessary) Secondary Default Gateway fields. Click Apply. The

## CONFIGURE E-MAIL

information is sent to the SNAP PAC, but it cannot communicate on the secondary interface until it is restarted.

5. In the Operation Commands section, highlight Restart Device from powerup. Then click Send Command.

The SNAP PAC controller is restarted. You can check to make sure the controller is back on line by clicking Status Read again and making sure the secondary IP address information is shown. To verify communication, open PAC Manager on a PC that is on the same network segment as the secondary IP address, and use the Inspect window to check status.

## CONFIGURE E-MAIL

You can send an email message or page someone in response to an event. Use this dialog box to set up email parameters. See [“Configure Event Messages” on page 268](#) to set up the message itself.

**IP Address and Port.** Enter the IP address and port number of the Simple Mail Transfer Protocol (SMTP) server the I/O unit will use to send email. You should be able to get this information from your network administrator.

**Timeout.** Enter the length of time in milliseconds the I/O unit should wait for a response from the email server. The default is 30,000.

**From.** Enter a valid email address that will identify the I/O unit to the person who receives the email.

**To.** Enter the email address of the person who will receive the email.

**Subject.** Enter a phrase that will indicate the purpose of the email to the person receiving it. Note that this subject line applies to all email messages sent by this I/O unit. Plugins can be used in this field. For example, if a similar email will be sent at intervals (such as an email of the data log), you can use the seqid plugin to put a sequence number at the end of each subject line. This plugin is in the format:

\$!\_seqid\_

So, for example, if you enter Ultimate Data Log \$!\_seqid\_ in the subject field, the first email message will have a subject line of Ultimate Data Log 0, the next message will have a subject line of Ultimate Data Log 1, and so on. For information on other plugins, see [“Using Plugins” on page 111](#).

*IMPORTANT: For the configuration to take effect, you must upload the configuration file to the brain, save it to flash memory, and restart the brain.*

## CONFIGURE EVENT MESSAGES

PAC-R  
EB  
UIO  
EIO

**If you are using PAC Control or PAC Manager 9.0 or higher,** configure event messages in the configuration file as shown on [page 108](#).

**If you are not using PAC Control or are using a PAC Manager version less than 9.0,** you cannot configure event messages in a configuration file. Instead, use PAC Manager’s Inspect mode and follow the steps below. Note that event messages are not available on SB brains, since messaging requires an Ethernet connection.

1. In the PAC Manager main window, click the Inspect button .
  - If you have not used the Inspect window before, the window will not show any data. Select your controller from the drop-down list.

- If you *have* used the Inspect window before, the last device you inspected is shown in the Device Name field, and current Status Read information appears in the window.

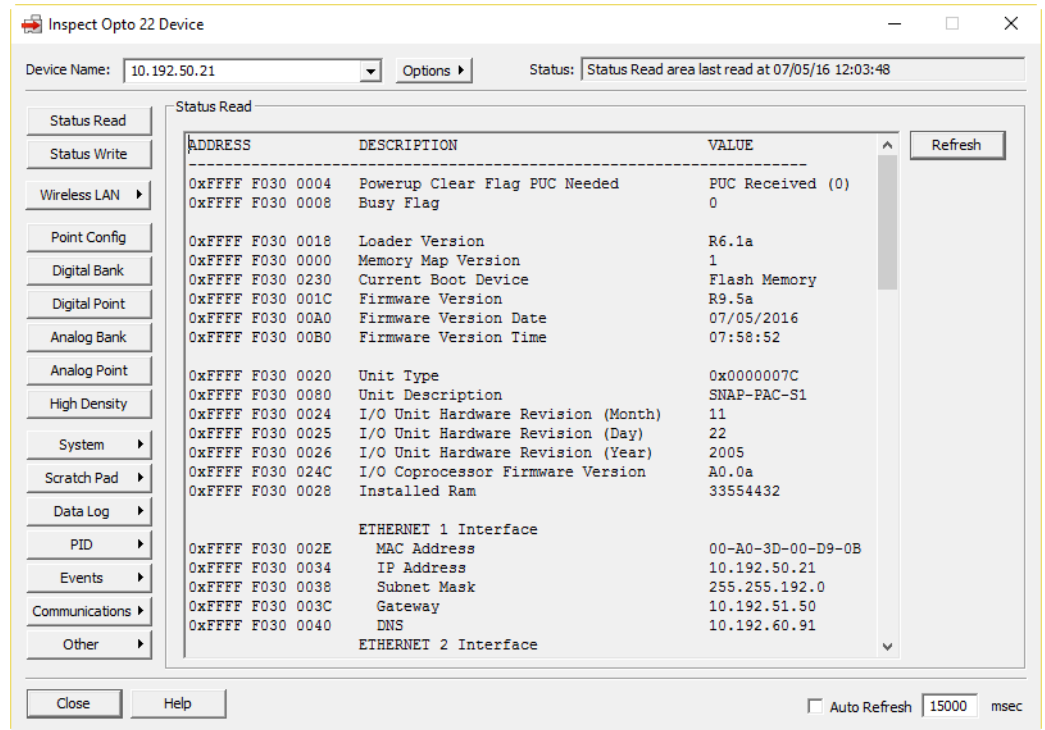

- If you have configured other devices, they are listed in alphabetical order in the drop-down list.
- If you have configured six or more devices, the Inspect window provides two additional time-saving features: Next and Back navigation buttons (to navigate back and forth through the alphabetized list of devices), and a list of the five most recently inspected devices (displayed at the top of the drop-down list).

Next and Back navigation buttons and Most Recently Used list are displayed when you have six or more devices configured.

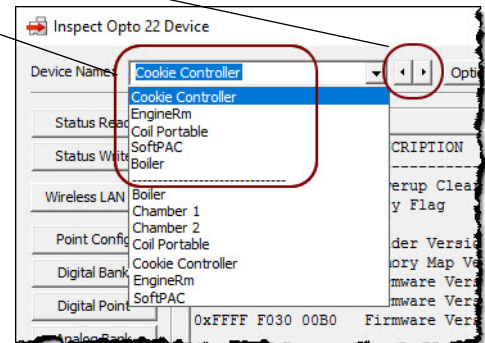

2. In the Device Name field, type the name (or IP address) of the I/O unit (or choose it from the drop-down list).

- Click Events and choose Event Messages from the submenu.

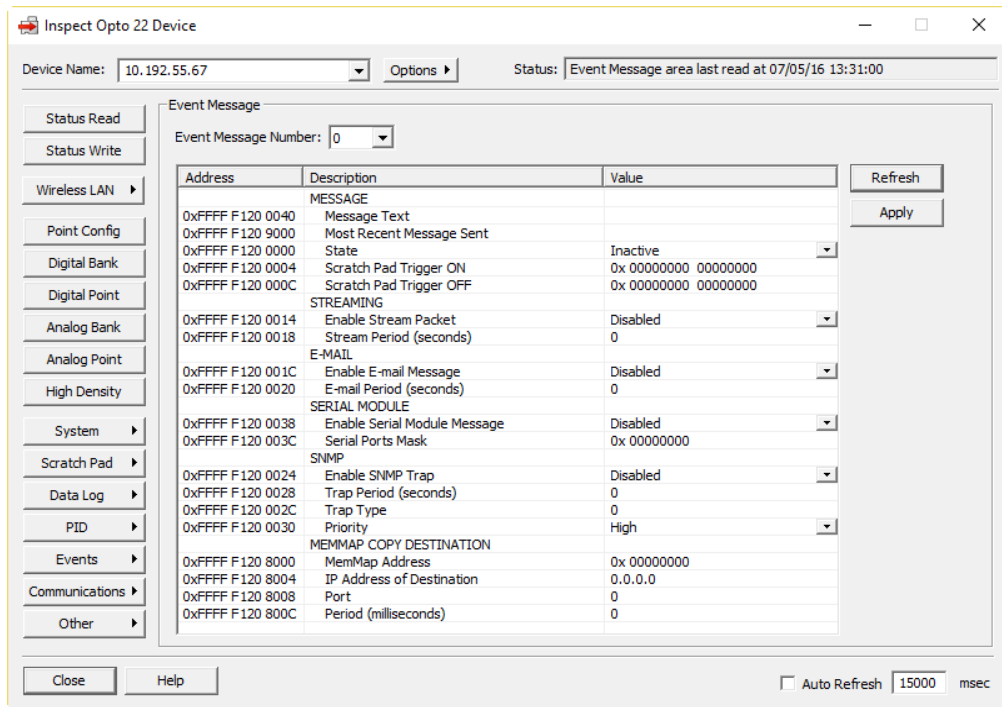

- From the drop-down list, choose the lowest unused message number. Unused message numbers have no asterisk.
- For an email or serial message, or optionally for an SNMP message, enter the message text. Message text is not sent in the streaming packet. Message text is limited to 127 characters. You can place data from the I/O unit's memory map into the message by using a plugin (see [page 111](#)). If you are sending a serial message, make sure the text is formatted so the serial device that receives it will understand it.
- Enter two masks indicating the Scratch Pad on and off bits that should trigger the message. For help in figuring out the masks, see ["Digital Point and Scratch Pad Masks" on page 151](#).
- Streaming section: To send a stream of data as the message, choose Enabled from the drop-down list. Enter how often in seconds to send the stream (0 sends it only once). For information on streaming, see [page 112](#).
- E-mail section: To send an email message, choose Enabled from the drop-down list. Enter how often in seconds to send the email (0 sends it only once).
- Serial Module section: To send a message through a serial module to a serial device, choose Enabled from the drop-down list. Enter a mask representing the modules and ports to receive the message. Information in ["Configuring Serial or Wiegand Events and Reactions" on page 159](#) may be helpful.
- SNMP section: To send an SNMP trap as the message, change Disabled to Enabled. Enter how often to send the trap (0 sends it only once). Also enter the trap type (determined by your SNMP management software). If you are using SNMP with outgoing PPP and want the trap stored in the I/O unit until the next communication, set Priority to Low. If you want the I/O unit to immediately dial out and send the trap, set Priority to High. For information on SNMP, see [page 112](#).

*NOTE: SNMP messages must be acknowledged. You can do so in your application or in PAC Manager's Inspect window: in the Message section, change the State to Acknowledge and click Apply.*



11. Memmap Copy Destination section: To copy memory map data, complete this section using information from “Copying Memory Map Data” on page 125.
12. When all fields are correct, click Apply.
13. Repeat from step 4 to configure additional event messages.
14. For each type of message you configure, make sure you also set up basic configuration:

Serial: See page 60  
 SNMP: See page 112  
 Email: See page 116  
 Streaming: See page 120

15. When you have finished configuring all event messages and any additional configuration required for them, in the PAC Manager Inspect window, make sure the IP address shown is the correct one. Then click the Status Write button in the upper-left part of the window.
16. In the Operation Commands list, highlight Store configuration to flash.

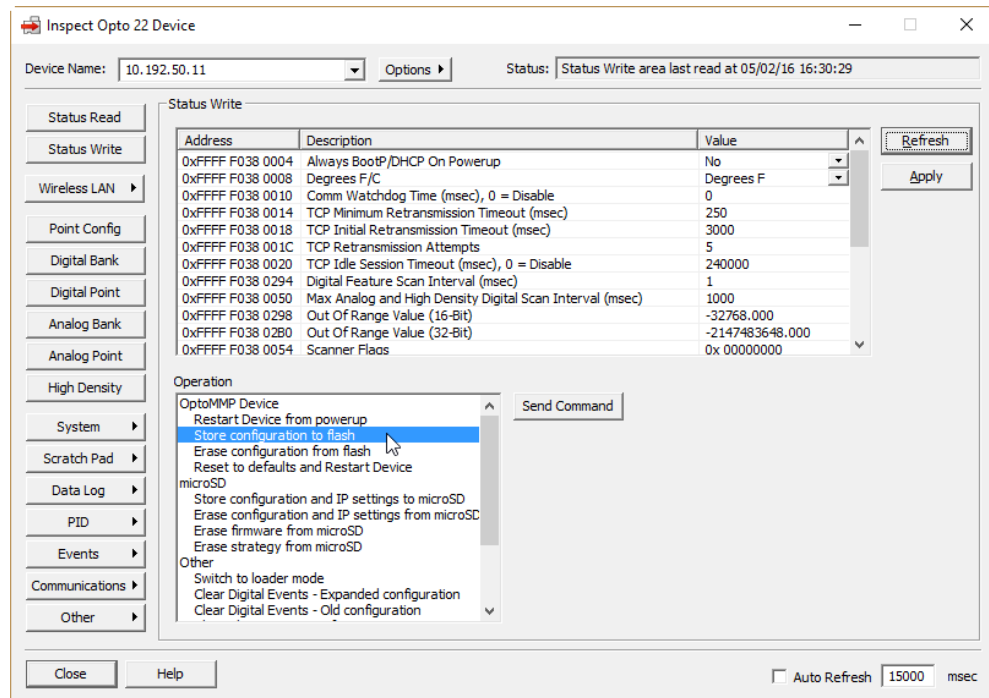

17. Click Send Command.  
 The configuration data is stored to flash memory and a Success message appears.

*IMPORTANT: For the following configurations, you must also restart the unit for configuration to take effect:*

*Changes in TCP port for serial modules                      SNMP configuration*  
*Email configuration    PPP configuration*  
*Data logging interval*

## CONFIGURE I/O POINTS

18. If you have configured any of these items, in the Operation Commands list, highlight Restart I/O Unit from powerup. Click Send Command.  
The I/O unit is restarted and a success message appears.

## CONFIGURE I/O POINTS

SNAP I/O units are configured by first adding a SNAP module, then configuring each point on that module. SNAP modules and points are listed in an expandable, tree-like view. The window is resizable.

**I/O Unit.** Displays the I/O unit on which I/O points are being configured.

**Type.** Displays the type of I/O Unit for which points are going to be added. This field is for display purposes only and cannot be modified.

**Add.** To add I/O points to a SNAP I/O Unit, you must first add a SNAP module to the I/O Unit, then add I/O points to that module.

### To add a SNAP module to an I/O Unit

Highlight the location where the module will be added and click the Add button. In the Add Module dialog that appears, select the type of module (Analog Input/Output or Digital Input/Output) and the name of the SNAP module you are configuring. Click OK.

### To add an I/O point to a SNAP module

Double-click a SNAP module in the list to see the point locations it contains. Highlight the location where the point will be added and click the Add button. Depending on whether the I/O point being added is analog or digital, enter configuration information for the new I/O point in either the [Add/Edit Analog Point](#) or [Add/Edit Digital Point](#).

**Modify.** To change an existing SNAP module or I/O point, highlight the item in the list and click the Modify button. Change configuration information for the SNAP module or I/O point in the Add Module dialog, the [Add/Edit Analog Point](#) or the [Add/Edit Digital Point](#) as necessary.

**Delete.** To delete an existing SNAP module or I/O point, highlight the item in the list and click Delete. Before deleting a SNAP module, you must first delete all I/O points associated with that module. When deleting I/O points, note that only points having a reference count of zero can be deleted.

**Move To.** To move an I/O point to an empty channel on another (or the same) I/O Unit, highlight the point, click Move To, and use the [Move Point To](#) to move the point. If the I/O point is referenced in a PID loop or event/reaction, you can move the point only within the same I/O unit, not to another unit.

**Expand All/Collapse All.** To view or hide all I/O points in a SNAP I/O unit, click the Expand All button or the Collapse All button.

## CONFIGURE I/O POINTS (G4EB2)

G4EB2 I/O units are configured by adding a point for each G4 module.

**I/O Unit.** Displays the I/O unit on which I/O points are being configured.

**Type.** Displays the type of I/O Unit for which points are going to be added. This field is for display purposes only and cannot be modified.

**Add.** Points that have not been configured yet show as Not Used. Double-click the channel number for the point you want to add. Enter configuration information for the new I/O point. See [“Configuring Digital Points for a G4EB2” on page 52](#).

**Modify.** To change an existing point, highlight the item in the list and click the Modify button. See [“Configuring Digital Points for a G4EB2” on page 52](#).

**Delete.** To delete an existing point, highlight the item in the list and click Delete. When deleting I/O points, note that only points having a reference count of zero can be deleted.

**Move To.** To move an I/O point to an empty channel on another (or the same) I/O Unit, highlight the point, click Move To, and use the [Move Point To](#) to move the point. If the I/O point is referenced in a PID loop or event/reaction, you can move the point only within the same I/O unit, not to another unit.

## CONFIGURE I/O UNITS

This dialog box shows all the I/O units in the current configuration and is the “home base” for configuring I/O. For more details on configuring I/O and features, see [Chapter 2: Configuring Devices](#).

To resize the dialog box, move the mouse near any edge until the pointer turns into a two-way arrow, then click and drag the border in any direction. To resize a column, click and drag the column dividers in the list header, or double click the divider to expand the column just wide enough to display the longest item in the column.

**To configure a new I/O unit**, click Add or double-click anywhere in the list box below any configured units. The [Add/Edit I/O Unit](#) dialog box will appear.

**To change an I/O unit** in the list, highlight it and click Modify and change the unit’s settings in the [Add/Edit I/O Unit](#) dialog box.

**To remove an I/O unit** in the list, highlight it and click Delete. Only I/O units with a reference count of zero can be deleted.

**To add or modify I/O points** for the highlighted I/O unit, click I/O Points. The [Configure I/O Points](#) dialog box will appear.

**To copy and save I/O Unit configurations**, click Import/Copy and select I/O units in the [I/O Unit Import/Copy](#) dialog box that appears.

To configure additional items, click the buttons shown below:

Click **PID Loops** to configure proportional-integral derivative (PID) loops on SNAP PAC brains or R-series controllers.

- Click **Modules** and select a module type:
  - Serial Modules  
(see [“Configuring RS-232 and RS-485/422 Serial Communication Modules” on page 60](#))
  - Wiegand Modules  
(see [“Configuring Wiegand Modules” on page 65](#))
  - PID Modules  
(also see [“Configuring PID Modules” on page 67](#))
  - Profibus Modules  
(see [“Configuring Profibus Modules” on page 68](#))
  - Motion Modules  
(see the [SNAP PAC Motion Control User’s Guide](#), form 1673)

## CONFIGURE MEMORY MAP VALUES

- SSI Modules  
(see “[Configuring SSI \(Serial Synchronous Interface\) Modules](#)” on page 69)
- CAN Modules  
(see “[Configuring CAN Modules](#)” on page 71)
- HART Modules  
(see “[Configuring HART Modules](#)” on page 75)
- Click **Events** and select an event to define or an event message to send as a reaction to an event.
- Click **Scratch Pad** to view and configure bitmask, integer, float, and string memory areas of a SNAP PAC controller or brain.

*NOTE: If you are using the Scratch Pad on a SNAP PAC S-series controller, you must first configure an I/O unit to represent the controller. Configure this I/O unit as a Generic OptoMMP Device, using the IP address for the controller. (Do not add any points or configure other features.)*

- Click **Communications** and select the type of communication to configure, for example, PPP, Modbus, Security, Streaming, and so on.
- Click **Others** to configure date and time, data logging, or I/O unit options you want to have saved in the configuration file.

## CONFIGURE MEMORY MAP VALUES

Use this dialog box to assign values to specific memory map locations that are not otherwise included in configuration files. These values will be sent to the I/O unit or controller when you send the configuration file. For memory map addresses and valid values, see the [OptoMMP Protocol Guide](#) (form 1465).

*NOTE: If you are using a SNAP PAC S-series controller, you must first configure an I/O unit to represent the controller. Configure this I/O unit as a Generic OptoMMP Device, using the IP address for the controller. (Do not add any points or configure other features.)*

The Memory Map Values List displays the Address, Value and Type of each Memory Map Value. The Address is always represented in hexadecimal (hex). The Value field can contain hex or decimal values (integer types only). If the value is in hex it is preceded by 0x. The Type field can be either 4-byte Int, 8-byte Int, Float, or String.

- To add a new Memory Map Value, click **Add** to open the [Add/Edit Memory Map Values](#) dialog box.
- To change an existing Memory Map Value, highlight it and click **Modify**.
- To delete an existing Memory Map Value, highlight it and click **Delete**. To highlight more than one, hold down the Ctrl key and click additional items in the list.

## CONFIGURE PID LOOPS

Use this dialog box to configure proportional integral derivative (PID) loops on SNAP PAC brains, and R-series controllers. You can configure up to 96 PID loops. Four algorithms are available to choose from. See also “[Configuring PID Loops](#)” on page 78.

- To add a PID, highlight the lowest available number in the list and click **Add** to open the Add/Edit PID dialog box.
- To change an existing PID, highlight it in the list and click **Modify**.
- To delete a PID, highlight it and click **Delete**.

Each PID must be configured with essential parameters and then individually tuned for efficiency. You can configure PIDs through either PAC Manager or PAC Control, but for tuning PIDs, it’s easier to use the graphic tuning tools in PAC Control. (For details, see the [PAC Control User’s Guide](#), form 1700.)

## CONFIGURE PID MODULES

*NOTE: This section is for legacy PID modules. These modules are not recommended for new development. Instead, use the PID loops provided on the I/O unit itself. SNAP PAC R-series, SNAP PAC EB, and SNAP PAC SB I/O units provide 96 PID loops each; SNAP Ultimate I/O units provide 32; SNAP Ethernet I/O units provide 16. See [page 78](#).*

To configure PID modules, you will also need the [SNAP PID Module User's Guide](#) (form 1263), available at [www.opto22.com](http://www.opto22.com).

1. In the Configure I/O Points dialog box, double-click the number that represents the PID module's position on the rack.
2. In the Add Module dialog box, choose Analog Input as the type and then choose SNAP-PID-V as the module. Click OK.  
The module appears in the Configure I/O Points dialog box.
3. Close the Configure I/O Points dialog box and return to the Configure I/O Units dialog box. Choose one of the following ways to enter PID values and set parameters for a SNAP-PID-V module:
  - If you want to iteratively tune a PID loop, use OptoENET PID Module Tuner. This software includes graphing features and is available free from the Opto 22 Web site. See the [SNAP PID Module User's Guide](#) (form 1263) for instructions; do NOT continue with the following steps.
  - If you have previously calculated PID values and parameters, use PAC Manager. PAC Manager does not provide visual feedback of changes to PID values. You must first calculate optimal PID values for your application using the PID velocity algorithm and the PID variable formulas described in the [SNAP PID Module User's Guide](#) (form 1263). After calculating these values, continue with [step 4](#).
4. In the Configure I/O Units dialog box, click the Modules button and choose PID Modules from the pop-up menu.

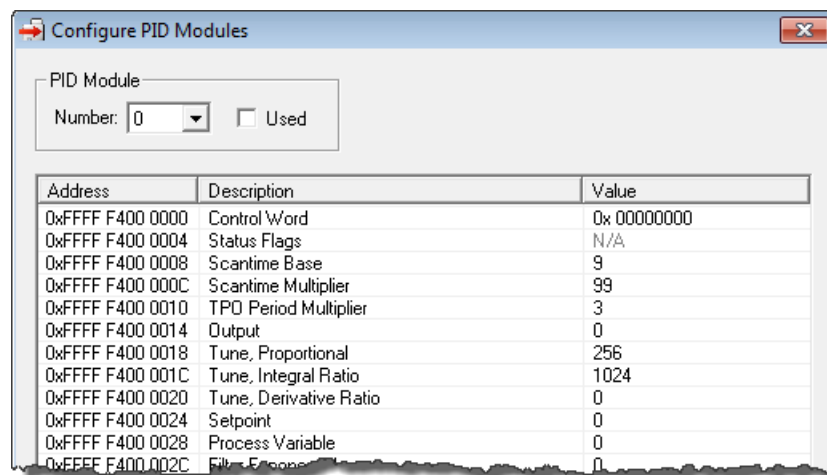

5. From the Number drop-down list, choose the number of the PID module on the rack.
6. Click to place a check mark in the Used box.
7. For each item you want to set, click its cell in the Value column and change the value.  
For descriptions of items, see the [SNAP PID Module User's Guide](#) (form 1263).
8. Repeat for each PID module you want to configure.
9. When you have finished configuring PID modules, click OK to close the dialog box and return to configuring I/O units.

When you are ready to send all configuration data to the I/O unit, see [“Sending Configuration Data to the I/O Unit” on page 83](#).

## CONFIGURE PPP

**Local IP Address.** Enter the Local IP Address for the PPP interface on the I/O unit. Enter the local Subnet Mask only if you are using classless IP addressing. If you are not using classless IP addressing, leave the Subnet Mask at zero, and the I/O unit will calculate the subnet mask.

*IMPORTANT: The network address for the PPP interface must be different from the network ID for the Ethernet interface. (The network address is obtained by ANDing the IP address and the subnet mask.)*

**Max Authentication Retries.** Enter the maximum number of times a login/password combination can be retried.

**PPP Link Always Connected.** If you want outgoing PPP to always be connected, so there is no need for the I/O unit to dial out, check this box.

**Modem Initialization String.** Change the modem initialization string and modem hangup string if necessary. Make sure you use the setting to ignore DTR signal in the modem initialization string:

The default modem initialization string is `AT&D0^M~~~~`

Consult the command reference that came with your modem to determine the correct initialization command strings. A sample modem initialization string might look like this:

`AT&F^M~~~AT&D0&K0^M~~~AT&W0^M~~~AT&Y0^M~~~`

The &F command sets the modem back to factory defaults. The ^M tells the Ethernet I/O unit to insert a carriage return. The ~ tells it to insert a 500ms pause. The &W0 writes the current settings to NVRAM profile 0 on the modem. The &Y0 instructs the modem to use NVRAM profile 0 after resetting.

This initialization string is just a sample; command strings for your modem may differ.

**Outgoing PPP.** If the I/O unit will send outgoing calls, complete the Outgoing PPP section:

Choose Enabled from the drop-down list.

In the Use Local IP Address field, choose Yes to have the I/O unit use the Local IP Address you entered for the PPP link; choose No to have the remote device assign the I/O unit an IP address for the PPP link. The default is No.

If you want the I/O unit to use the device the I/O unit is calling as the default gateway for all communication, choose Yes for Set As Default Gateway. The default is No.

Enter the Login and Password the I/O unit should use for authentication when it calls the remote device.

In the Phone number field, enter the number the modem should dial for outgoing calls from the I/O unit.

Change the following fields if necessary:

- Inactivity Timeout—If the I/O unit sends no packets and receives no packets for this number of seconds after the PPP session is negotiated, the modem will hang up. The default is 30.
- Max Connect Time—The maximum amount of time in seconds an outgoing PPP connection can stay connected after successful negotiation. Default is zero, which disables the timer.
- Max Dial Retries—The number of times the I/O unit will redial if the first attempt fails. Default is zero.
- Retry Interval—The number of seconds the I/O unit will wait before trying to redial after the first attempt fails. Default is zero.
- Disable Time—If the maximum connect time or maximum number of retries has been reached, the outgoing PPP dialer waits this number of seconds before doing anything. Default is zero.

**Incoming PPP.** If the I/O unit will receive incoming calls via modem, complete the Incoming PPP section:

Choose Enabled from the drop-down list so the modem will listen for incoming calls.

If you want the I/O unit to use the device calling the I/O unit as the default gateway for all communication, choose Yes for Set As Default Gateway. The default is No.

Change the Inactivity Timeout if necessary. The default is 30.

Enter the Login and Password the I/O unit should accept for incoming calls.

In the Remote IP Address field, enter the IP address the I/O unit should give to devices that dial into the I/O unit and ask for an address. This address must be on the same subnet as the local IP address.

Enter a modem listen string to make sure the modem automatically answers calls. The default modem listen string is `ATS0=1^M~`, which instructs the modem to answer any incoming calls on the first ring. Again, refer to your modem's command reference for the correct listen string.

## CONFIGURE PROFIBUS MODULES

(Not applicable to SB brains) Profibus modules (part number SNAP-SCM-PROFI) are a type of serial module. Before configuring a Profibus module, see the [SNAP Serial Communication Module User's Guide](#) (form 1191) for more information about these modules.

1. With the configuration file open, right-click the name of the I/O unit the Profibus module is on. From the pop-up menu, choose Configure. The Configure I/O Units dialog box opens.

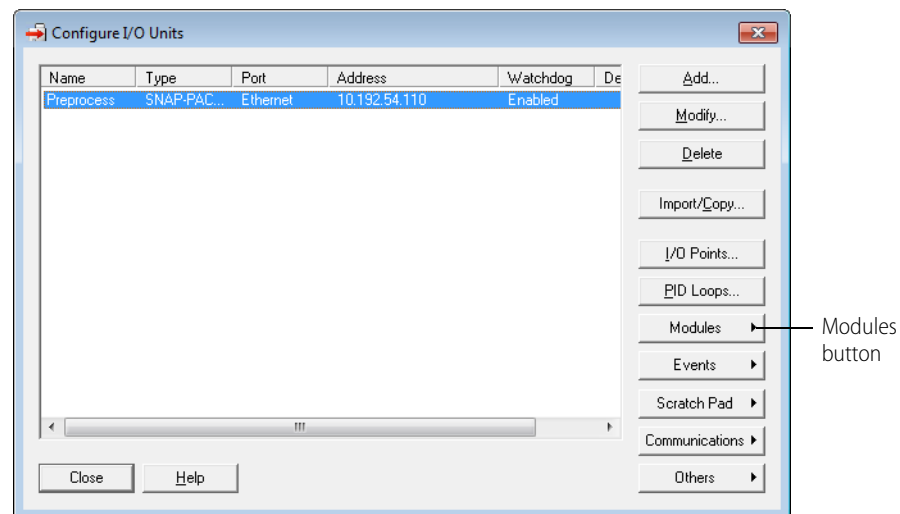

## CONFIGURE SERIAL MODULES

2. Make sure the correct I/O unit is highlighted. Click the Modules button and choose Profibus Modules from the pop-up menu.

Address	Description	Value
MODULE INFORMATION		
0xFFFF F0C0 0000	Module Type	Dig/none (0x00)
0xFFFF F03A 7F00	Module Subtype	0
0xFFFF F03A 7F02	Hardware Revision Date	N/A
0xFFFF F03A 7F06	Loader Version	N/A
0xFFFF F03A 7F0A	Firmware Version	N/A
PORT A		
0xFFFF F03A 8000	IP Port Number	22500
0xFFFF F03A 8004	Baud Rate	19200
0xFFFF F03A 8008	Parity	Even
0xFFFF F03A 8009	Data Bits	8
0xFFFF F03A 800A	Stop Bits	1
0xFFFF F03A 800B	Hardware Flow Control?	No
0xFFFF F03A 800C	Power-up Test Message?	Yes
0xFFFF F03A 8200	EOM Character List	0x 0D0A0000

3. In the Number field, choose the Profibus module's position from the drop-down list. Click to put a check mark in the Used box.
4. If you need to change port numbers, enter the new numbers for each port in the TCP port Number field.
5. Change the Baud Rate and EOM Character List fields if necessary to match your Profibus devices. Choose whether to have the module automatically send a Test Message when turned on (the default is Yes).
6. When data is correct, repeat from [step 3](#) for additional Profibus modules.
7. When all Profibus modules are configured, click OK to close the dialog box and return to configuring I/O units.
8. When you are ready to send all configuration data to the I/O unit, see ["Sending Configuration Data to the I/O Unit"](#) on [page 83](#).

*IMPORTANT: If you have changed a TCP port number, you must save the change to flash and restart the I/O unit when you send the configuration data to the I/O unit (see ["Sending Configuration Data to the I/O Unit"](#) on [page 83](#)).*

## CONFIGURE SERIAL MODULES

This dialog allows you to configure SNAP serial communication modules (part numbers SNAP-SCM-232 and SNAP-SCM-485) for use with the I/O unit. For each serial module port you want to use, click the corresponding row and then enter or modify the values in the columns listed below. Most values can be changed by selecting a new value from a drop-down list.

**Status.** To enable a port on a serial module, select the appropriate row and click the Status column. A drop-down list is displayed with the choices Enabled, Disabled, and Clear. Choosing Enabled activates the entire row and assigns default values to each column. Choosing Disabled deactivates the row but doesn't change any values in the other columns. Choosing Clear deactivates the row and clears all the other columns. Only the columns that are Enabled will be sent to the I/O unit.

**Module.** The module location on the SNAP I/O rack. This value cannot be changed.



**Port.** The serial module port being configured. Each serial module has two ports, A and B. This value cannot be changed.

**IP Port.** The IP Port number for access to the serial port. The default value that appears should work for most IP communication, and changing this value shouldn't be necessary. If the IP port number is changed, however, the I/O unit must be restarted for the change to take effect.

**Baud Rate.** Choose the baud rate. The default is 9600.

**Parity.** Choose None, Odd, Even, Mark or Space from the drop-down list. The default is None.

**Data Bits.** Choose 8 or 7 from the drop-down list. The default is 8.

**Stop Bits.** Choose 1 or 2 from the drop-down list. The default is 1.

**EOM Chars.** Enter hexadecimal values representing the End Of Message characters that the I/O Unit should be looking for. The default is 0D0A, which is the ASCII representation for carriage return and linefeed. A maximum of eight hexadecimal digits may be entered.

**Test Message.** Select Yes in the drop-down list if you want the I/O Unit to send a test message on powerup. Select No if no test message is desired. The default value is Yes.

## CONFIGURE SNMP AGENT

**SysName.** Enter the name assigned to the I/O unit as a managed node within the SNMP management system.

**SysLocation.** Enter the physical location of the I/O unit.

**SysContact.** Enter the ID of the contact person for the I/O unit.

**Community Groups.** To set up the Community Groups you need, highlight a line in the list. Click the String cell within the line and type the name of the group. Then click in the Read, Write, and Trap cells and choose Yes or No from the drop-down list to indicate whether that group has privileges to read, write, and receive traps.

**Management Hosts.** To set up Management Hosts, highlight a line in the list. Start with hosts on the local network first, because the system sends messages to hosts in numeric order, and it stops sending messages when it finds a host that it cannot connect to. Click the Community String cell and enter the name of the community group the host belongs to. Click the Host IP Address cell and enter its IP address, including the dots (for example, 10 . 192 . 55 . 60).

**Version.** (All I/O units except SNAP Simple and SNAP Ethernet) From the drop-down list, choose the version of SNMP you are using.

**Destination Port.** 161 is the default port for SNMP communications. If you know that your application will use a different port, enter the number of that port here.

**Authentication/Cold Start Trap.** To enable authentication or cold start traps, click the box to check it.

## CONFIGURE STREAMING

**Enable Streaming.** To enable streaming, choose Yes from the drop-down list.

**Enable I/O Mirroring.** I/O mirroring is a separate function. It's generally not a good idea to use both streaming and mirroring on the same I/O unit. See ["Mirroring I/O Point Data" on page 123](#) for more information.

**Interval.** Enter how often in milliseconds you want the I/O unit to send the streamed data. If you are configuring streaming to use only as an event message, set the streaming interval to 0. Zero means that the stream will be sent only once.

**Use Default Streaming Area.** To stream all addresses in the Streaming section of the I/O unit's memory map, click Use Default Streaming Area. For more information, see the memory map appendix in the [OptoMMP Protocol Guide](#) (form 1465). (Note that the Streaming section does not include data from high-density digital modules.)

To stream only part of the Streaming section, or to stream a different part of the memory map, click Specify Streaming Area. Enter the starting address in the Memory Map Address field (the address must be entered in hex), and enter the size in bytes of the data to stream in the Size Of Data field.

**IP Port.** Enter the IP port on the PCs or devices that receive the streamed data. Your application must refer to this port number. Use the default of 5001 unless you know it is already being used for another purpose.

**Stream Target.** Enter the IP addresses of up to eight devices to receive the streamed data.

## CONFIGURE WIEGAND MODULES

(Not applicable to SB brains) Wiegand modules are a type of serial module. Before configuring a Wiegand module, see the [SNAP Serial Communication Module User's Guide](#) (form 1191) for more information about these modules.

1. With the configuration file open, right-click the name of the I/O unit the Wiegand module is on. From the pop-up menu, choose Configure. The Configure I/O Units dialog box opens.

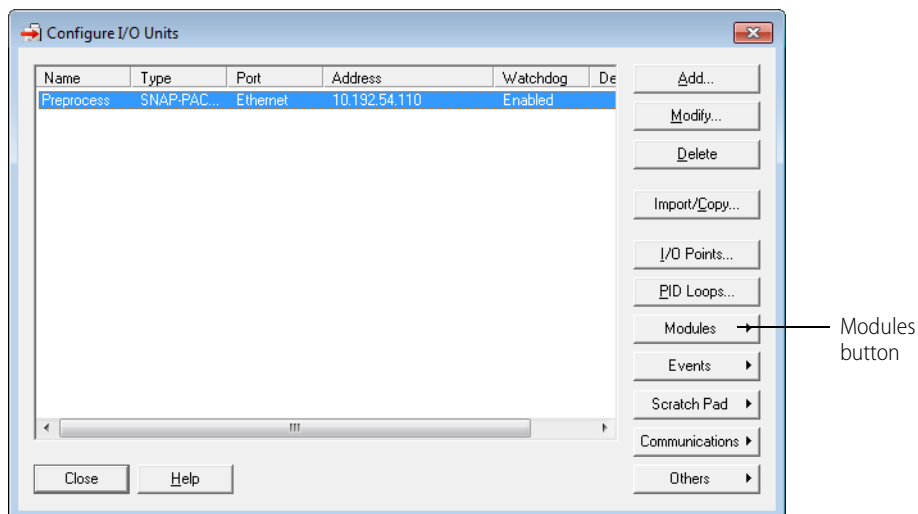

2. Make sure the correct I/O unit is highlighted. Click the Modules button and choose Wiegand Modules from the pop-up menu.

Address	Description	Value
MODULE INFORMATION		
0xFFFF F0C0 0000	Module Type	Dig/none (0x00)
0xFFFF F03A 8501	Module Subtype	0
0xFFFF F03A 8502	Hardware Revision Date	N/A
0xFFFF F03A 8506	Loader Version	N/A
0xFFFF F03A 850A	Firmware Version	N/A
PORT A		
0xFFFF F03A 8600	IP Port Number	22500
0xFFFF F03A 8604	Format	0
0xFFFF F03A 8608	Data Length	37
0xFFFF F03A 860C	Site Position	9
0xFFFF F03A 8610	Site Length	9
0xFFFF F03A 8614	Badge Position	18
0xFFFF F03A 8618	Badge Length	19
0xFFFF F03A 861C	Parity Check	No
0xFFFF F03A 8620	Even Parity Position	0
0xFFFF F03A 8624	Odd Parity Position	0
PORT B		
0xFFFF F03A 8640	IP Port Number	22501
0xFFFF F03A 8644	Format	0
0xFFFF F03A 8648	Data Length	37
0xFFFF F03A 864C	Site Position	9
0xFFFF F03A 8650	Site Length	9
0xFFFF F03A 8654	Badge Position	18
0xFFFF F03A 8658	Badge Length	19
0xFFFF F03A 865C	Parity Check	No
0xFFFF F03A 8660	Even Parity Position	0
0xFFFF F03A 8664	Odd Parity Position	0

3. In the Number field, choose the Wiegand module's position from the drop-down list. Click to put a check mark in the Used box.
4. If you need to change port numbers, enter the new numbers for each port in the TCP port Number fields.
5. Click the Format/Value cell, and from the drop-down list, choose a standard data format (shown by its total data length) or choose C for custom.

*NOTE: 0 is the 37-bit Opto 22 format used in a sample PAC Control strategy available for use with Wiegand modules. For details, see the [SNAP Serial Communication Module User's Guide \(form 1191\)](#).*

6. Change the following fields if necessary to match your Wiegand hardware device:
  - Data Length—total length of data in the transmission
  - Site Position—first bit of the site code
  - Site Length—length of the site code, in bits
  - Badge Position—first bit of the badge code (should be the next bit after the site code)
  - Badge Length—length of the badge code, in bits
7. When data for both ports is correct, repeat from [step 3](#) for additional Wiegand modules.
8. When all Wiegand modules are configured, click OK to close the dialog box and return to configuring I/O units.

## FIND OPTO 22 MMP DEVICES

*IMPORTANT: If you changed a TCP port number, you must save the change to flash and restart the I/O unit when you send the configuration data to the I/O unit (see [page 83](#)).*

9. When you are ready to send all configuration data to the I/O unit, see [“Sending Configuration Data to the I/O Unit” on page 83](#).

## FIND OPTO 22 MMP DEVICES

Use this dialog box to find out the MAC addresses, IP addresses, firmware versions, and/or unit types of all Opto 22 memory-mapped devices on the network. Opto 22 memory-mapped devices include SNAP PAC and SNAP-LCE controllers, SNAP Ethernet, SNAP Ultimate, and SNAP Simple I/O units, and E1 and E2 I/O units. (Opto 22 M4-series controllers with Ethernet cards are not included.)

*CAUTION: You may have problems if your network includes old Opto 22 SNAP Ethernet brains with firmware version R1.3m or earlier, or controllers with M4SENET-100 adapter cards at firmware version R1.3k or earlier (these may be affected by the Find feature even though it does not report them). These brains and adapter cards may have to be rebooted if you use the Find feature. To avoid this problem, update the older devices to newer firmware first.*

1. Leave the **MMP Port** at 2001 unless you have changed it for security purposes.
2. Adjust the **Timeout** if necessary for your network. Timeout is in milliseconds.
3. Click **Find**. All the Opto 22 MMP devices on your network are listed. The total number of devices is shown in the Devices Found field.
4. If you want to copy device information to the clipboard, click **Copy**.

## INSPECT OPTO 22 DEVICE

When you use the Inspect Opto 22 Device window, you are reading and writing directly to a specific SNAP PAC controller or brain. You must have its IP address in order to do so. The type of device determines which areas are supported.

*CAUTION: Any configuration changes you make here are not saved in a configuration file.*

To use the Inspect Opto 22 Device window, enter the IP address of the device (or choose it from the drop-down list). Then click the button on the left that corresponds to what you want to do:

**Status Read.** See basic information about a SNAP PAC controller or brain. See [“Interpreting Status Data” on page 167](#).

**Status Write.** Send commands to a device (such as Store configuration to flash), change the unit’s basic configuration (such as whether degrees are shown in F or C), or assign the second IP address on a SNAP PAC controller (see [“Assign Secondary IP Address” on page 267](#)).

**Wireless LAN.** Choose to configure a wireless LAN or view a wireless LAN’s status. See [“Configuring Wireless LAN Communication \(Wired+Wireless Models Only\)” on page 35](#).

**Point Config.** Configure I/O points. See [“Configuring Analog and Digital Points and Features” on page 179](#).

**Digital Bank, Analog Bank.** Read I/O points. See [“Reading Analog and Digital Banks” on page 200](#).

**Digital Point, Analog Point.** Read or write to individual I/O points. See [“Reading and Writing to Points” on page 192](#).

**High Density.** Read or write to SNAP high-density digital points. See [“Reading and Writing to SNAP High-Density Digital Points” on page 203.](#)

**System.** Read or change the date and time. See [“Reading System Date and Time” on page 206.](#)

**Scratch Pad.** Read or write to Scratch Pad Bits, Integers, Floats, and Strings. See [“Reading and Writing to the Scratch Pad Area” on page 206.](#)

**Data Log.** Configure data logging and read the log. See [“Data Logging” on page 209.](#)

**PID.** Configure PID loops and PID modules. See [“Configuring, Viewing, or Changing PID Loops” on page 190.](#)

**Events.** Read current events and change events; configure event messages. See [“Configuring Event Messages” on page 161.](#)

**Communications.** Display information about and configure security, protocols, communication ports, and a variety of modules including serial modules (RS-232, RS-485/422, Wiegand, Profibus, Motion, SSI, CAN, and HART modules). For information on how to configure these modules, see [“Configuring I/O Modules and Points” on page 48.](#)

**Other.** Read or write to any address in the device’s memory map. For a complete list of memory map addresses, see the [OptoMMP Protocol Guide](#) (form 1465).

## I/O UNIT IMPORT/COPY

Use this dialog box to import and copy I/O unit flash memory images. An I/O unit’s flash memory contains information about any settings that have been explicitly configured for that unit. A flash memory image saves this information so it can be stored in a file or copied to another I/O unit. The dialog box contains:

**Existing I/O Unit Flash Memory.** Choose an existing I/O unit. If you want to add or modify an I/O unit, click Options. For help, see [“Add/Modify New Device” on page 265.](#)

**Previously Saved I/O Unit Image File.** Select this option and enter the filename of a flash memory image file that you want to copy to another I/O unit. You can also click the Browse button at the end of the filename field and locate the image file using the standard File Open dialog box.

**Read.** After selecting an Image Source option, click Read to read a flash memory image from an I/O unit or an existing flash memory image file. Note that the dialog box does not close when you click this button.

**Send Image To I/O Unit Flash Memory.** Select this option and enter an I/O unit’s IP address to copy the selected flash memory image source to that unit.

**Save To I/O Unit Image File.** Select this option and enter the name of a file that will store the flash memory image. You can also click the Browse button at the end of the filename field and specify the name and location of the image file using the standard File Save dialog box.

**Create New I/O Unit.** Select this option to create a new I/O unit in PAC Manager using the selected flash memory image source. Since the source image does not contain an I/O unit name, you will be prompted to enter one. For more information, see [“Creating a New I/O Unit from an Existing One” on page 42.](#)

**Send/Save/Create.** After selecting an Image Destination option, click this button to copy the image source to an I/O unit, save the image source to a file, or create a new I/O unit in PAC Manager. Note that the dialog box does not close when you click this button, so you can repeat the Read-Send/Save/Create cycle as needed.

## I/O UNIT MAINTENANCE

To use the I/O Unit Maintenance dialog box, see one of the following topics:

[“Changing IP Addresses” on page 223](#)

[“Installing New Firmware” on page 225](#)

[“Maintaining Files” on page 239](#)

For other maintenance tasks, such as resetting the device to factory defaults or handling a device whose IP address you don't know, see the controller or brain user's guide.

## MOVE POINT TO

Use this dialog to move an I/O point from one I/O unit to a location on another (or the same) I/O unit.

The **I/O Units** list displays all I/O units that are compatible with the point being moved. The current I/O unit is highlighted. The **Points** list displays all I/O points on the highlighted I/O unit. Currently configured I/O points are in gray text, and open channels are marked Unused.

1. Select an open channel on the current I/O unit or select another I/O unit (if available) from the I/O units list and select one of its channels as the destination channel.
2. Click OK to move the I/O point to the specified channel.

## SCALE ANALOG READINGS

This dialog box is used to specify a custom scale factor that will convert from the “real” units of a module to some engineering units which describe the process parameter being measured.

**Scaled Units.** Type the name of the new engineering units (EU) for the module here. (Simply delete the default scale and type a new scale—for example, PSI.) As soon as you press Tab or click outside this field, the name of the new EU appears in the protected (grayed-out) Scaled columns in the Lower Value and Upper Value areas of the dialog box.

**Actual Lower Value.** Provide the actual real-world lower value that you wish the scaled lower value to correspond to. By default, the zero-scale value appears.

Note that inputs typically have under-range capability, which means you can specify a lower actual value less than the zero-scale value. Outputs do not have under-range capability.

**Actual Units.** The actual units of the module appear here. They are displayed for reference only and cannot be changed.

**Scaled Lower Value.** Type in the new scaled lower value here. This can be any floating point value.

**Scaled Units.** The name of the new units you typed in the Scaled Units field (above) appear here.

**Actual Upper Value.** Provide the actual real-world upper value that you wish the scaled upper value to correspond to. By default, the full-scale value appears.

Note that inputs typically have over-range capability, which means you can specify an upper actual value greater than the full-scale value. Outputs do not have over-range capability.

**Actual Units.** The actual units of the module appear here. They are displayed for reference only and cannot be changed.

**Scaled Upper Value.** Type in the new scaled upper value here. This can be any floating point value, as long as it is greater than the scaled lower value.

**Scaled Units.** The name of the new units you typed in the Scaled Units fields (above) appear here.

## SEND CONFIGURATION TO I/O UNIT

Use this dialog box to send configuration information to one or more I/O Units.

**I/O Units List.** The list on the left shows all the I/O units in this configuration file. When you click a unit, the Address List shows all the IP addresses associated with the highlighted unit. This is the address list you set up in the [Add/Edit I/O Unit](#).

### Sending Configuration Information

1. Highlight the I/O unit configuration(s) you want to send.
2. Highlight the IP addresses to receive the I/O unit configuration. If you don't highlight any addresses, the configuration will be sent to the entire list. If you highlight more than one I/O unit configuration, each unit configuration will automatically be sent to all the IP addresses associated with it.
3. If necessary, change the Timeout field. The timeout field shows how long, in milliseconds, PAC Manager will try to communicate with the I/O unit before returning a timeout error.
4. To save the configuration file to flash memory as well as to RAM, check Save to Flash. To also restart the unit, check Restart Device.

*IMPORTANT: For the following configurations, you must save to flash and restart the I/O unit in order any changes to the configuration to take effect:*

- Changes in IP port for serial modules
- SNMP configuration
- Email configuration
- PPP configuration
- Data logging interval

**Clearing Flash.** To erase the flash memory of all highlighted I/O units in the list, click Clear Flash. Click **Details** to show or hide the Status Area, which displays the results of the last Send or Clear Flash operation.

SEND CONFIGURATION TO I/O UNIT



# Index

## A

- accessing data log, 105
- address, assigning IP address, 15
  - to multiple devices, 27
- alarm
  - clearing configuration, 217
  - configuring, 157, 211
  - description, 156
  - trigger, 156
  - types, 156
- algorithms for PIDs, 79
- analog bank
  - data format, 221
  - reading, 200
- analog module data format, 222
- analog point
  - average filter weight, 86, 90
  - bipolar, 88
  - calibrating, 58, 196
  - clamping, 86, 90
  - configuring, 54, 178
  - features, 88
  - gain, 86
  - maximum value, 86
  - minimum value, 86
  - minimum/maximum value, 89
  - offset, 86
  - offset and gain, 58, 89, 196
  - reading, 195
  - scaling, 56, 86, 88
  - unipolar, 88
  - viewing data, 178
  - watchdog, 86, 88
  - writing to, 195
- assigning IP address, 15, 27
- average filter weight, 86, 90

## B

- bootloader mode, for loading firmware, 236

## C

- CA root certificate, 238
- calibrating analog point, 58, 86, 196
- CAN modules
  - configuring, 71
- cascading events and reactions, 146
- changing
  - I/O points automatically, 123
  - IP address, 223
- clamping analog output point, 86, 90
- clearing
  - configuration, 217
  - configuration data from flash memory, 85
  - data log, 106
  - file from I/O unit, 244
  - files from flash memory, 244
  - resetting to defaults, 214
- communicating with I/O unit
  - assigning IP address, 15
  - monitoring communication, 88
- communicating with processor
  - IP address, 15
- communication
  - dial-up, 139
  - modem, 139
  - PPP, 139
  - serial, 134
  - wireless, 35
- community groups, 113
- configuration data on microSD card, 215
- configuration file, 39
  - adding analog point, 54
  - adding digital point, 49
  - adding I/O unit, 44

- copying, 77
- creating, 40
- creating from a PAC Control strategy, 44
- custom scaling, 56
- loading to brain, 83
- moving I/O point, 77
- configuration, clearing, 217
- configuring
  - alarm events and reactions, 156
  - alarms, 157
  - CAN modules, 71
  - communications port, 134
  - copying I/O configuration, 41
  - data logging, 103
  - data streaming, 120
  - date and time, 132
  - delayed reactions to events, 152
  - digital event/reactions, 150
  - email, 116
  - event messages, 108
  - event/reactions, 149
  - I/O, 39, 178
  - I/O unit, 44
  - mistic I/O units, 13, 14
  - PID loops, 78, 190
  - PID modules, 67
  - PPP, 139
  - Profibus modules, 68
  - RS-232 and RS-485/422 serial modules, 60
  - Scratch Pad, 118
  - serial event/reactions, 159
  - serial modules, 189
  - serial ports on brain or controller, 134
  - serial synchronous interface (SSI) modules, 69
  - SNMP, 112
  - Wiegand event/reactions, 159
  - Wiegand modules, 65
  - wired network security, 94
  - wireless LAN, 35
- control engine port, changing, 97, 100
- controller
  - assigning IP address, 15
  - changing IP address, 223
  - control engine port, 97
  - restarting, 213
- converting IEEE float, 221
- copying
  - I/O configuration, 41
  - memory map data, 125
- counter
  - description, 85, 87
  - quadrature, 88

## D

- data
  - copying from memory map, 125
  - formatting and interpreting, 218
  - IEEE float format, 221
  - streaming, 108, 120
- data format
  - 2-channel analog modules, 222
  - digital bank counters, 219
  - digital channel, 220
  - IEEE float, 221
  - mask, 218
- data logging
  - accessing data, 105
  - clearing data log, 106
  - configuring, 103, 209
  - values from memory map addresses, 103
- date and time
  - configuring, 132
  - reading, 206
- deadband, 158
- deleting
  - configuration data from flash memory, 85
  - file from I/O unit, 244
- deviation alarm, 156
- DHCP server, 15
- diagnostic messages, 249
- dial-up networking, 139
- digital bank
  - counter data format, 219
  - reading, 200
- digital channel
  - data format, 220
- digital event/reactions
  - clearing, 217
  - configuring, 150, 211
  - description, 150
  - examples, 152
  - trigger, 152
- digital point
  - configuring, 49, 178
  - counter, 85, 87
  - features, 85
  - latching, 85, 87
  - on high-density module, 203
  - quadrature counter, 85, 88
  - reading, 193
  - state, 85, 87
  - viewing data, 178
  - watchdog, 86, 88
  - writing to, 193
- disable host communication, 97

DNS Resolver, 115  
downloading  
    *see* loading or installing

## E

edge trigger, 156  
email  
    clearing configuration, 217  
    configure DNS server, 115  
    configuring, 116, 212  
    message, 108  
erase  
    configuration from microSD, 217  
    firmware from microSD, 217  
    strategy from microSD, 217  
error messages, 247  
Ethernet 2 IP address, assigning, 30  
Ethernet errors, 253  
EtherNet/IP  
    turning off protocol, 97  
event message  
    configuring, 108, 211  
    plugins, 111  
event/reaction, 150, 152, 211  
    cascading, 146  
    configuration steps (table), 149  
    configuring digital, 150  
    delayed, 152  
    Scratch Pad, 145  
    serial, 159  
    types, 147  
    Wiegand, 159  
exclamation mark button, 249

## F

failsafe bootloader mode, 236  
file  
    clearing from flash memory, 244  
    deleting from file system, 244  
    loading from flash memory to file system, 244  
    reading filenames, 243  
    sending from I/O unit, 243  
    sending to I/O unit, 241  
file storage, removable, 239  
file system on brain or controller, 239  
filter address, 100, 103  
filter mask, 100, 103  
filter weight, 90  
find Opto 22 MMP devices, 250  
firmware  
    effect on device data, 225

    failsafe bootloader, 236  
    for serial module, 232  
    getting data about, 248, 250  
    loading to controller, 225  
    loading to I/O unit, 225  
    replacing damaged, 236  
flash memory, 85  
    clearing files, 244  
    loading files from, 244  
    saving configuration data to, 83, 212  
    saving file system files, 244  
float  
    format, 221  
    IEEE, 221  
    Modbus, 128  
flow control, 62  
format  
    IEEE float, 221  
    Modbus float, 128  
    of counter data, 219  
    of data, 218  
    of data for 2-channel analog modules, 222  
    of digital channel data, 220  
FTP  
    client software comparison, 239  
    default port, 94  
    limiting access to, 94  
    login, 96  
    password, 96  
    reading filenames, 243  
    sending files to and from I/O unit or controller,  
        239

## G

G4EB2  
    configuring points, 52  
gain, 58, 89, 195, 196  
    definition, 86  
gateway address, 18, 25

## H

hardware, getting data about, 248, 250  
help  
    troubleshooting, 247  
high limit alarm, 156  
high-density digital modules  
    reading or writing to points, 203  
host communication, disabling, 97  
host name, 15  
    configure DNS server, 115

## I

- I/O modules
  - configuring analog and digital, 39
  - configuring RS-232 and RS-485/422 serial modules, 60
  - viewing, 178
- I/O point
  - clearing configuration, 217
  - configuring, 49, 178
  - features, 85
  - logging data, 103
  - mirroring, 123
  - reading, 192
  - reset points to defaults, 214
  - writing to, 192
- I/O unit
  - adding, 44
  - changing IP address, 223
  - clearing files from flash memory, 244
  - copying between configuration files, 77
  - deleting file, 244
  - file system, 239
  - getting files via FTP, 243
  - hardware commands, 212
  - loading files from flash memory, 244
  - reading basic information, 165
  - restarting, 213
  - saving files to flash memory, 244
  - sending files via FTP, 241
- IEEE float, 221
- initializing Scratch Pad values, 118
- installing
  - new firmware to I/O unit or controller, 225
- interacting algorithm for PID, 79
- IP address
  - assigning, 15
  - assigning IP address to Ethernet 2, 30
  - assigning to multiple devices, 27
  - assigning wireless, 35
  - changing, 223
  - mapping, 27
- ISA algorithm for PID, 79

## K

kernel, *see* firmware

## L

- latch, 87
  - definition, 85
- level trigger, 152

- loading
  - configuration file, 83
  - files from flash memory, 244
  - firmware
    - effect on device data, 225
    - new firmware to I/O unit or controller, 225
    - new firmware to serial module, 232
- logging
  - data, 103
  - serial port data, 253
  - wireless data, 255
- login for FTP, 96
- low limit alarm, 156

## M

- MAC address, 15
- management hosts, 113
- map file, 27
- mapping IP addresses, 27
- mask
  - data format, 218
  - digital point, 151
  - Scratch Pad, 151
- maximum value, 86, 89
- memory
  - saving configuration to, 212
  - saving files, 244
- memory map
  - copying data, 125
  - logging data from, 103
- message, 108
  - plugins, 111
- microSD card, 239
- microSD commands, 215, 217
- minimum value, 86, 89
- mirroring I/O point data, 123
- mistic I/O units, 13, 14
- MMP devices, finding, 250
- Modbus/TCP
  - changing float format, 128
  - configuring, 212
  - default port, 94
  - limiting access to, 94
  - memory map address conversion, 130
- modem, 139
- module types, 181
- MOMO, 150
- mounting rack
  - M-series, 174
  - SNAP PAC, 174
- moving
  - files from I/O unit, 243

- files to I/O unit, 241
- I/O point in configuration file, 77
- must-on, must-off, 150

## N

- network
  - find OptoMMP devices, 250
  - security on wired network, 94
  - security on wireless LAN, 35

## O

- off, 87
- off-latch, 85, 87
- offset, 58, 89, 195, 196
  - definition, 86
- on, 87
- on-latch, 85, 87
- operation commands, 212
- OptoMMP
  - default port, 94
  - find devices, 250
  - limiting access to, 94
- OptoMMP device commands, 212

## P

- PAC Control, 145, 165
  - and direct reads and writes, 165
  - and event/reactions, 145
  - copying configuration files from, 44
  - managing files on I/O unit or controller, 239
  - protecting strategy, 97
- parallel algorithm for PID, 79
- password
  - for FTP, 96
- peak, 86
- PID loops
  - algorithms, 79
  - configuring, 78, 190
- PID modules
  - configuring, 67, 211
  - reading, 211
- plugins, 111
- point types, 181
- port
  - changing, for security, 94
  - serial, on brain or controller, 134
- ports for serial modules, 176
- power
  - powerup clear, 215
  - restarting controller, 213

- restarting I/O unit, 213
- powerup clear, 215
- PPP
  - clearing configuration, 217
  - configuring, 139, 212
  - troubleshooting serial communication, 253
- primary IP address, assigning, 15
- problems, troubleshooting, 247
- processor
  - assigning IP address, 15
- Product Support
  - getting device and firmware data, 248, 250
- Profibus
  - configuring modules, 68
- protecting PAC Control strategy, 97
- protocol
  - default ports, 94
  - limiting access to, 94
  - turning off EtherNet/IP, 97

## Q

- quadrature counter, 85, 88

## R

- reaction
  - delayed, 152
  - digital, 150
  - example, 152
  - Scratch Pad, 145
  - trigger
    - analog, 156
    - digital, 152
- reading
  - analog bank, 200
  - analog point, 195
  - data log, 105
  - digital bank, 200
  - digital point, 193
  - digital points on high-density modules, 203
  - filenames on file system, 243
  - I/O points, 192
  - I/O unit information, 165
  - Scratch Pad, 206
  - system date and time, 206
- registered management hosts, 113
- removable storage, 239
- reset points to defaults, 214
- reset to defaults and restart device, 214
- Restart device from powerup, 213
- retransmit timeout (RTO), 251
- root certificate, 238

## S

- saving
  - configuration to flash memory, 83, 212
  - file system files to flash memory, 244
- scaling
  - analog point, 56
  - description, 86, 88
- scanner flags, 173
- Scratch Pad, 145
  - masks, 151
  - reading, 206
  - setting initial values, 118
  - writing to, 206
- secondary IP address, assigning, 30
- security, 35, 94, 212
  - FTP login, 96
- send powerup clear, 215
- serial
  - communication, troubleshooting, 253
  - event/reactions, 159, 211
  - message, 108
  - ports on brain or controller, configuring, 134
- serial modules
  - 2-wire or 4-wire mode, 62
  - CAN, 71
  - flow control, 62
  - loading firmware, 232
  - port numbers, 176
  - Profibus, 68
  - serial synchronous interface, 69
  - Wiegand, 65
- serial modules (RS-232, RS-485/422)
  - configuring, 60
- serial synchronous interface
  - configuring modules, 69
- setting offset and gain, 58, 196
- SMTP
  - Configure DNS server, 115
- SNAP PAC controller
  - assigning IP address
    - Ethernet 2, 30
    - primary, 15
  - file system, 239
- SNAP PAC REST API, 4, 95
- SNMP
  - access privileges, 113
  - agent, 113
  - community groups, 113
  - configuring, 112, 212
  - default port, 94
  - limiting access to, 94
  - management hosts, 113

- message, 108
- trap types, 113
- SSI modules
  - configuring, 69
- state of digital point, 85, 87
- Status Read information, 167
- store configuration and IP settings to microSD, 216
- store configuration to flash, 212
- strategy
  - effect of firmware download, 225
  - protecting, 97
- streaming data, 108, 120, 212
- subnet mask, 15

## T

- TCP/IP
  - settings, 251
  - stack, 251
- time, system, 132, 206
- timed events, 154
- timeout, 251
- timer, configuring, 217
- traps, 113
- troubleshooting, 247
  - diagnostic messages, 249
  - Ethernet errors, 253
  - getting device and firmware data, 248, 250
  - serial communication, 253
  - Status Read data, 167
  - TCP settings, 251
  - wireless communication, 255

## U

- UDP and streaming data, 120

## V

- valley, 86
- velocity algorithm for PID, 79
- viewing module and point data, 178

## W

- watchdog, 88
  - definition, 86
- Wiegand
  - configuring modules, 65
  - event/reactions, 159, 211
- wireless LAN
  - configuring, 35
  - troubleshooting, 255

writing  
to analog point, 195  
to digital point, 193  
to digital points on high-density modules, 203  
to I/O points, 192  
to Scratch Pad, 206

