

## groov 5–60 VDC Output Modules

### Features

- > 12 channels per module
- > Module cover with LED indicates module status
- > Channel-specific LEDs simplify troubleshooting
- > Touch-sensitive pad triggers display of module information on *groov* EPIC® processor's display
- > Operating temperature: -20 to 70 °C
- > UL Hazardous Locations approved and ATEX compliant
- > Guaranteed for life



**GRV-ODCI-12 Output Module**

### DESCRIPTION

*groov* I/O modules are part of the *groov* EPIC® (Edge Programmable Industrial Controller) system. Wired directly to field devices (sensors and actuators), *groov* I/O translates the electrical signals from those devices into the digital language computers understand—so you can monitor and control devices and use their data wherever you need it, in your local computer network or in cloud services.

These *groov* DC output modules provide 12 isolated channels of 5–60 VDC output, each switching a separate DC load. The module features channel-specific LEDs for troubleshooting.

Choose the module you need based on your requirements:

- The **GRV-ODCI-12** includes a full set of features.
- The **GRV-ODCIS-12** switches output on or off only, offering a lower cost option for projects with simple requirements.

See “Features and Specifications” on page 2 for additional differences.

Wiring is simplified with a top-mounted connector, which provides spring-clamp terminals for common and field wiring. The connector is held in place by a single, captive retention screw but can be removed with the field wiring intact for wiring in advance or easier module field replacement.

A swinging, two-position cover protects wiring from inadvertent contact, as does the dead-front design. The two positions of the cover offer the option of more space to accommodate larger wire. The module cover provides a touch-sensitive pad; touch the pad and the *groov* EPIC processor displays information about the module, including specifications and a wiring diagram.

The module pivots into place and is held securely in place by a captive retention screw.

*groov* I/O modules are hot swappable (which means they can be installed or removed without turning off power to the unit) and self-identifying—as soon as you mount the module to the chassis, it communicates to the processor and identifies itself.

Each *groov* I/O module cover provides a large module LED to indicate module health at a glance.

All *groov* power supplies, voltage converters, pass-through power adapters, I/O modules, and processors are UL/cUL listed and compliant with the ATEX, Low Voltage, and EMC CE and UKCA directives. Each module is factory tested twice before shipment and most modules are guaranteed for life.



### Part Numbers

| Part         | Description   |
|--------------|---|
| GRV-ODCI-12  | DC digital output, 12 channels, 5–60 VDC, channel-to-channel isolation              |
| GRV-ODCIS-12 | DC digital output, 12 channels, 5–60 VDC, channel-to-channel isolation, on/off only |

## FEATURES AND SPECIFICATIONS

### Features

| Feature                      | GRV-ODCI-12 | GRV-ODCIS-12 |
|------------------------------|-------------|--------------|
| Number of channels           | 12          | 12           |
| Channel-to-channel isolation | x           | x            |
| On/off state                 | x           | x            |
| On/off totalization          | x           |              |
| Output pulsing               | x           |              |
| Watchdog Timeout Value       | x           | x            |

### Specifications

| Specification                                   | GRV-ODCI-12  | GRV-ODCIS-12                                  |
|---|--|---|
| Line Voltage Range (nominal)                    | 5–48 VDC   | 5–48 VDC                                      |
| Line Voltage Range (max)                        | 5–60 VDC   | 5–60 VDC                                      |
| Current Rating                                  | 400 mA per channel or 4.8 A per module (70°C)  | 400 mA per channel or 4.8 A per module (70°C) |
| Surge Current                                   | 5 A peak for 1 second  | 5 A peak for 1 second                         |
| Recommended Max. Fuse (fast) or Circuit Breaker | 3 A 60 VDC / channel, 6 A 60 VDC / module  | 3 A 60 VDC / channel, 6 A 60 VDC / module     |
| Minimum Load                                    | 20 mA  | 20 mA   |
| Output Voltage Drop                             | 1.2 V max.   | 1.2 V max.                                    |
| Off-State Leakage                               | 1 mA at 60 V   | 1 mA at 60 V                                  |
| Peak Blocking Voltage                           | 60 V   | 60 V  |
| TPO Period (min, max, resolution)               | 0.005 seconds, 429496.72 seconds, 0.001 seconds  | N/A   |
| Turn on/ Turn off Time                          | 2.5 ms   |   |
| Isolation (field-to-logic)                      | 300 V working, 1500 V transient (1 minute)   | 300 V working, 1500 V transient (1 minute)    |
| Isolation (channel-to-channel)                  | 300 V working, 1500 V transient (1 minute)   | 300 V working, 1500 V transient (1 minute)    |
| Number of Channels                              | 12   | 12  |
| Chassis Power Consumption                       | 1.2 W  | 1.2 W   |
| Minimum GRV-EPIC-PR1 Firmware Version           | 1.0.0  | 1.0.0   |
| Minimum PAC Project Version                     | 10.0000  | 10.0000                                       |
| Minimum Library Package for CODESYS Version     | 1.0.0.0  | 1.0.0.0                                       |
| Wire Size                                       | 28–14 AWG  | 28–14 AWG                                     |
| Torque, connector screw                         | 2.5 in-lb (0.28 N-m)   | 2.5 in-lb (0.28 N-m)                          |
| Torque, hold-down screw                         | 3.5 in-lb (0.4 N-m)  | 3.5 in-lb (0.4 N-m)                           |
| Temperature (operating)                         | -20 °C to +70 °C   | -20 °C to +70 °C                              |
| Temperature (storage)                           | -40 °C to +85 °C   | -40 °C to +85 °C                              |
| Relative Humidity (non-condensing)              | 5–95%  | 5–95%   |
| Agency Approvals                                | UL/cUL(Class 1 Div. 2) <sup>a</sup> ; CE, ATEX(Category 3, Zone 2), RoHS; DFARS; CB Scheme; UKCA |   |
| Warranty  | Lifetime   | Lifetime                                      |

a. For use in hazardous locations, equipment must be mounted in an enclosure that meets the requirements of the National Electrical Code, ANSI/NFPA 70, and ANSI/ISA-61010-1 (82.02.01).

Heading

Mount *groov* I/O modules onto a *groov* EPIC chassis (see [groov EPIC Chassis Data Sheet](#), form 2247). To learn the names and physical features of the parts of the module, see “Description of Module Parts” on page 15.

## Installing a Module

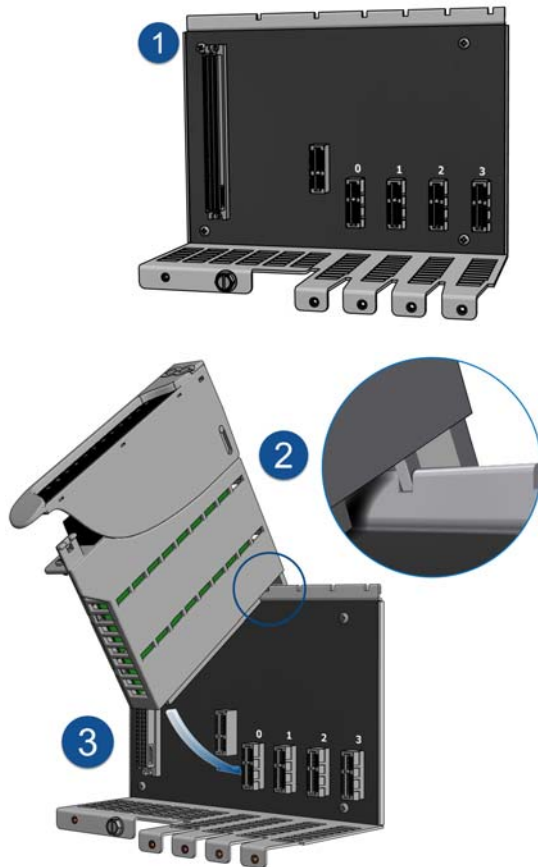

The numbers on the diagrams correspond to the numbered steps in these instructions.

**CAUTION:** For electrical safety, de-energize field devices wired to the terminal connector before starting.

1. Orient the *groov* EPIC chassis so that the module connector numbers are right-side up, with module connector zero on the left, as shown in the diagram.
2. Hold the module at a 45° angle, lining up the alignment tab on the back tip of the module with the slot at the back of the chassis.
3. Pivot the front of the module down to the module connector on the chassis. Push to snap the module into the connector.
4. Swing the module cover up so you can access the module retention screw. Secure the module into position by tightening the module retention screw.

**CAUTION:** Do not over-tighten. See the torque specs in the Specifications table.

5. If the module does not have a terminal connector, install one.
6. Secure the terminal connector by tightening the terminal connector screw.

**CAUTION:** Do not over-tighten. See the torque specs in the Specifications table.

7. Follow the wiring instructions in the Pinout and Wiring section to wire your field devices to the channels on the terminal connector.
8. When wiring is complete, swing the module cover back down to cover the wires. If the wires are too thick to close the module cover easily, lift the module cover, then raise the back of the module cover up to the higher position. Swing the module cover back down to cover the wires.

When you are done installing modules and wiring, if you powered down your unit, you can turn it back on.

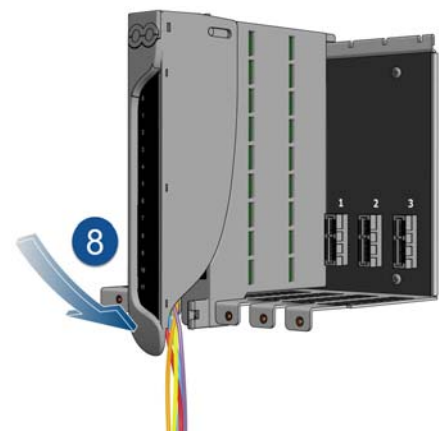

## Removing a Module

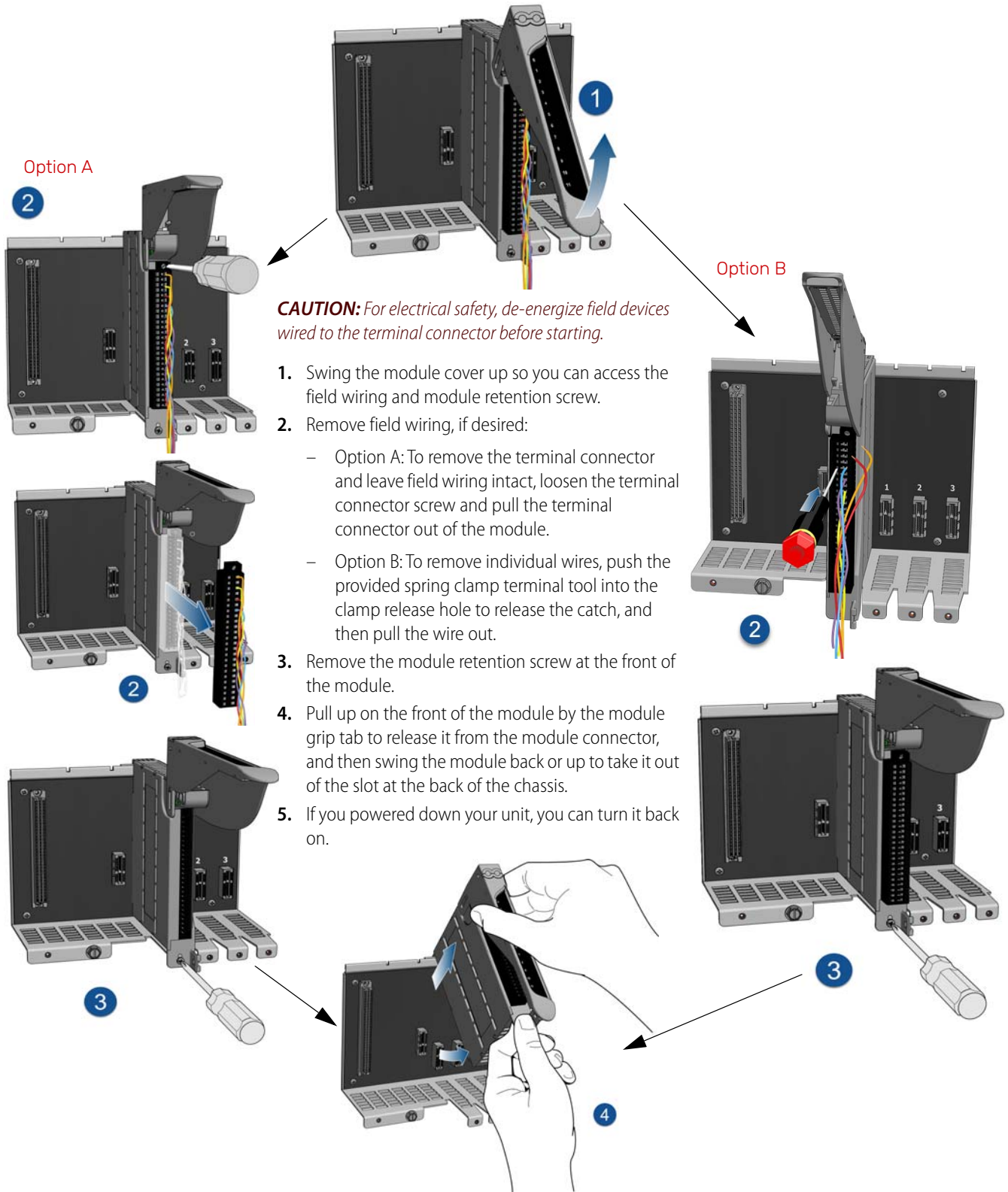

## PINOUTS AND WIRING

Before you begin wiring, do the following tasks:

- It may be easier to insert wires if you remove the terminal connector from the module. To remove the terminal connector, loosen the terminal connector screw at one end of the connector, then pull the connector straight out to remove it from the module.
- If you have never used a spring-clamp wiring system, take a moment to familiarize yourself with the diagram below. Insert the spring-clamp terminal tool in the clamp release hole. Insert field wires in the field wiring hole.
- If you look into the field wiring hole, you will see a highly reflective surface. If you can see that surface, that means that the clamp is closed.

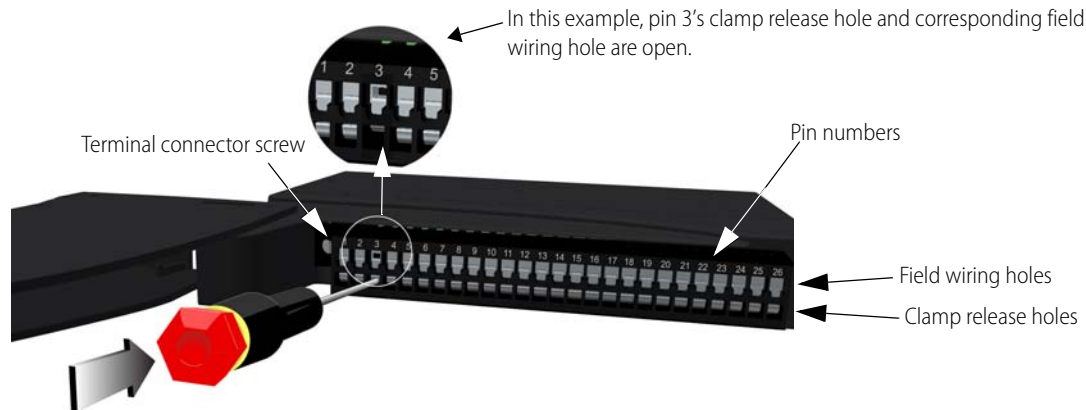

GRV-ODCI-12 and GRV-ODCIS-12 modules should be installed with appropriate external over-current protection devices (DC rated fuse or circuit breaker). See "Specifications" on page 2 for recommended values. Failure to provide adequate over-current protection may result in damage not covered by the Opto 22 warranty.

Follow these instructions to connect your field wires to the module:











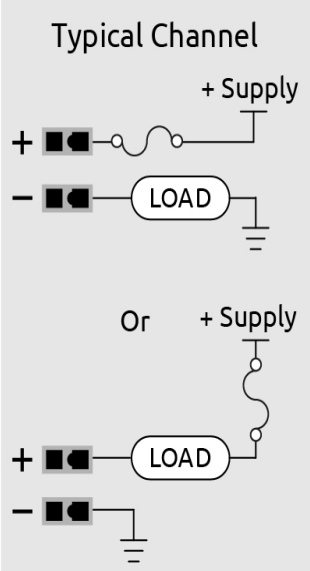



















1. Orient the module or terminal connector to match the wiring diagrams on the following page.
2. To make it easier to handle the spring-clamp terminal tool and the field wires, secure the module by doing one of the following:
  - If you are working with the terminal connector while it is attached to the module, make sure the module is screwed securely to the chassis.
  - If you are working only with the terminal connector, secure the terminal connector with a clamp.
3. Insert the spring-clamp terminal tool into the clamp release hole, then press and hold down the tool to open the clamp. Look into the field wiring hole. If it is dark, the clamp is open. You can go to [step 4](#). If you can still see the highly reflective surface, gently push down again and keep downward pressure on the spring-clamp terminal tool. Look into the field wiring hole. If it is dark, the clamp is open.

*Note: If you push in too hard, the spring-clamp terminal tool might pop out of the clamp release hole.*

4. Insert the wire into the field wiring hole until it meets complete resistance. Then pull out the spring-clamp terminal tool.
5. Test that the wire is secure by gently pulling on it. If the wire pulls out, repeat steps 3 and 4.

To remove a wire, push the spring-clamp terminal tool into the clamp release hole as described in [step 3](#) above, and then pull the wire out.

## WIRING: GRV-ODCI-12, GRV-ODCIS-12

| Internal                     | Pin   | External Wiring   |
|------------------------------|---|---|
| Channels internally isolated |   |   |
| Channel 0                    | 1  +         |  <p>Typical Channel</p> <p>+ Supply</p> <p>+  -  LOAD</p> <p>Or + Supply</p> <p>+  -  LOAD</p> <p>All loads require user supplied fuses</p> |
|                              | 2  -         |   |
| Channel 1                    | 3  +         |   |
|                              | 4  -         |   |
| Channel 2                    | 5  +         |   |
|                              | 6  -         |   |
| Channel 3                    | 7  +         |   |
|                              | 8  -         |   |
| Channel 4                    | 9  +         |   |
|                              | 10  -        |   |
| Channel 5                    | 11  +        |   |
|                              | 12  -      |   |
|                              | 13  Unused |   |
|                              | 14  Unused |   |
| Channel 6                    | 15  +      |   |
|                              | 16  -      |   |
| Channel 7                    | 17  +      |   |
|                              | 18  -      |   |
| Channel 8                    | 19  +      |   |
|                              | 20  -      |   |
| Channel 9                    | 21  +      |   |
|                              | 22  -      |   |
| Channel 10                   | 23  +      |   |
|                              | 24  -      |   |
| Channel 11                   | 25  +      |   |
|                              | 26  -      |   |

## DIMENSIONS: GRV-ODCI-12, GRV-ODCIS-12

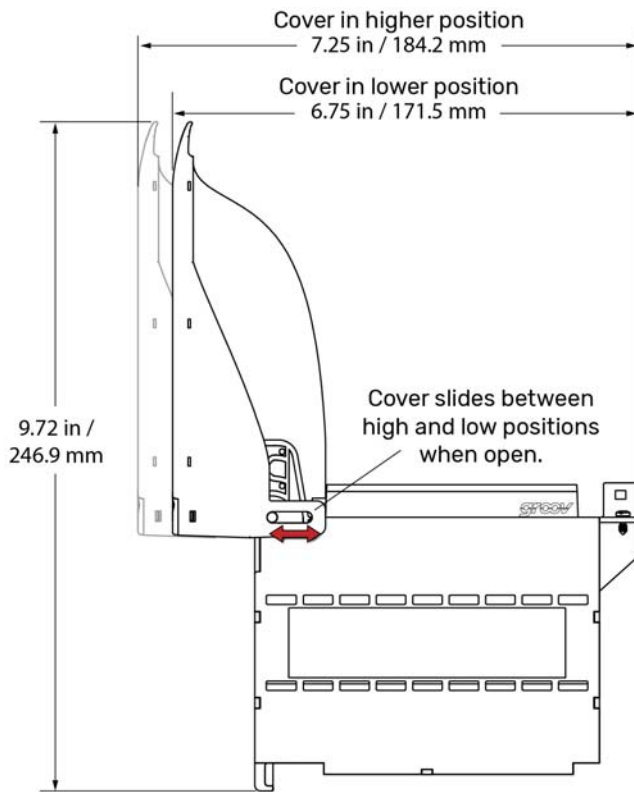

The module cover pivots and can be adjusted to two different heights (positions). The higher position provides more space to accommodate thicker wires.

To switch between higher and lower position, open the cover to at least a 45° angle. Grasp the hinged end of the module cover and do one of the following:

- Pull up on the back hinge to slide it to the higher position.
- Push down on the back hinge to slide it to the lower position.

You cannot switch between the higher and lower positions while the cover is closed.

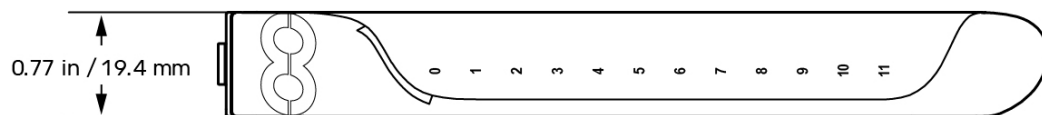
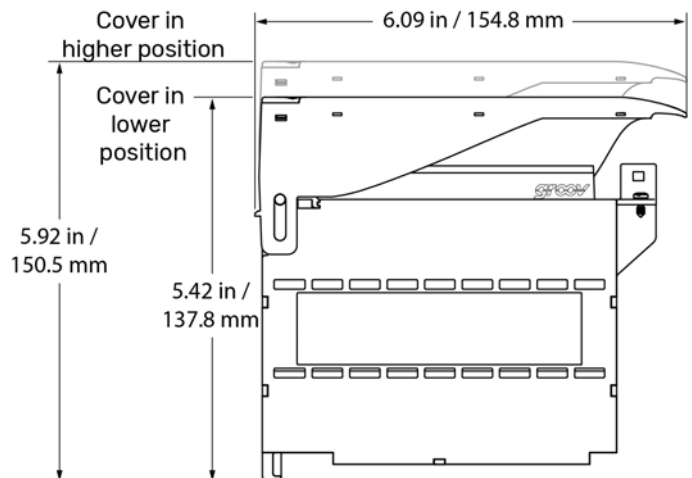
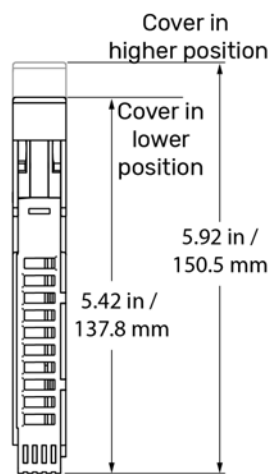

## DESCRIPTION OF MODULE PARTS

The following diagram identifies the parts of the modules. The installation instructions in the documentation rely on these terms to describe how to handle the module.

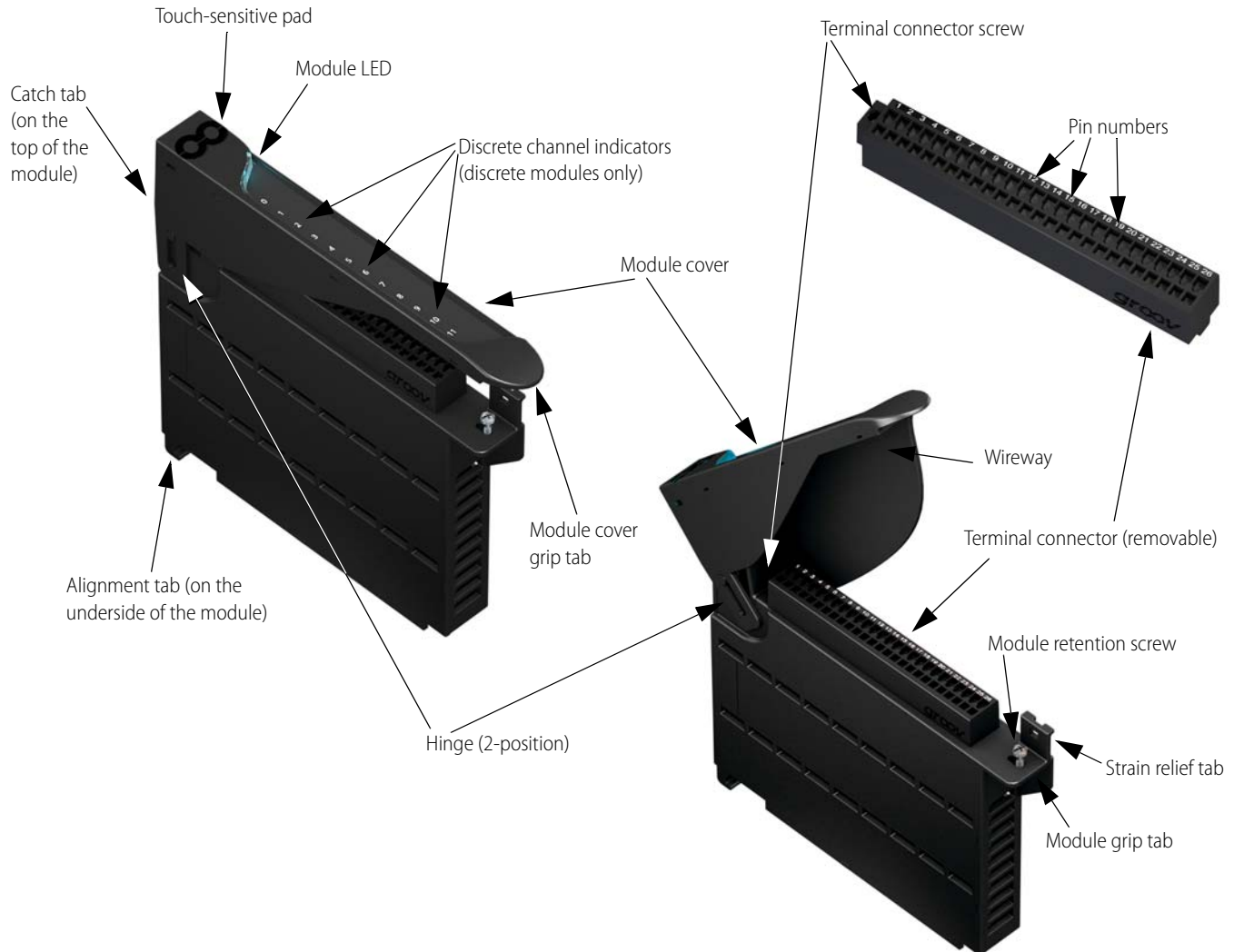

Some parts offer unique features:

- Module LED:** Provides a visual indication of the health of the module. For example, if it is blue, the module is operating normally. If it is blinking blue, the module's information is being displayed on the *groov* EPIC processor's screen. For a complete list of the various colors that this LED might display, see the [groov EPIC User's Guide](#) (form 2267).
- Hinge and Wireway:** These two features work together to provide more space for wires. The hinge can be adjusted between a lower position and a higher position. The wireway is the space underneath the module cover. To increase this space, you can raise the hinge to the higher position.
- Touch-sensitive pad:** Offers a convenient way to display the module's information on the *groov* EPIC processor. Press on the pad for approximately two seconds and the processor displays that module's information on the screen, as well as changing the module LED to a blinking blue light.
- Catch tab:** Located at the top of the module, the catch tab provides a place for the cover to "catch" or stop. This prevents the



cover from closing so that you can work on attaching or detaching wires to the terminal connector.

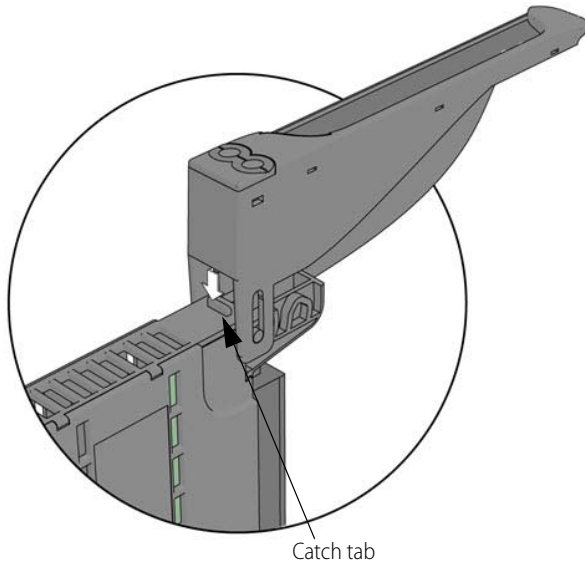

- **Strain relief tab:** This tab offers a way to collect wires into a bundle and secure them to the module. Attaching the wires to the strain relief tab can help hold the wires in a semi-fixed position, preventing them from interfering while you work on a nearby module. It also prevents strain on the part of the wire attached to the terminal connector.

Collect the wires into a bundle, pull a zip tie through the hole in the tab, wrap the zip tie around the bundle and tab, then clip the excess zip tie.

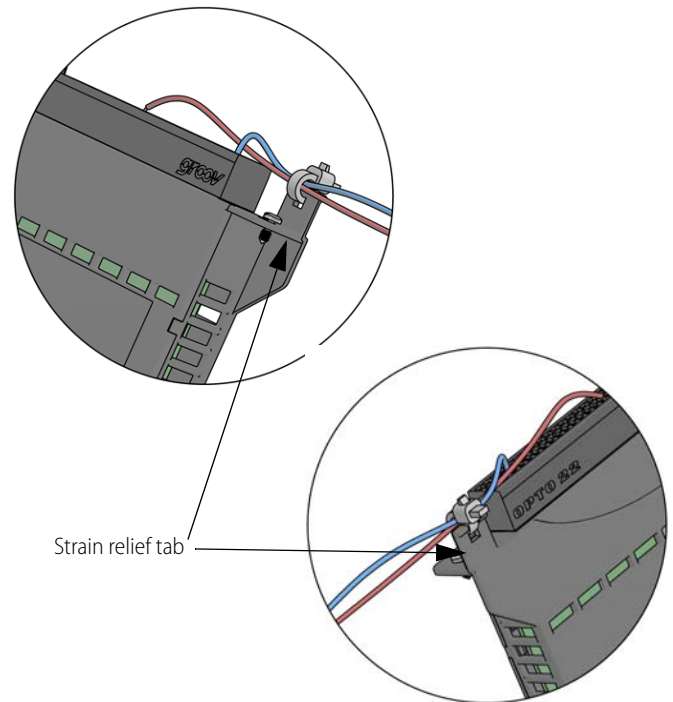

## PRODUCTS

Opto 22 develops and manufactures reliable, easy-to-use, open standards-based hardware and software products. Industrial automation, process control, remote monitoring, data acquisition, and industrial internet of things (IIoT) applications worldwide all rely on Opto 22.

### groov RIO®

groov RIO edge I/O offers a single, compact, PoE-powered industrial package with web-based configuration and IIoT software built in, support for multiple OT and IT protocols, and security features like a device firewall, data encryption, and user account control.

Standing alone, groov RIO connects to sensors, equipment, and legacy systems, collecting and securely publishing data from field to cloud. Choose a universal I/O model with thousands of possible field I/O configurations, with or without Ignition from Inductive Automation®, or a RIO EMU energy monitoring unit that reports 64 energy data values from 3-phase loads up to 600 VAC, Delta or Wye.

You can also use groov RIO with a Modbus/TCP master or as remote I/O for a groov EPIC system.

### groov EPIC® System

Opto 22's groov Edge Programmable Industrial Controller (EPIC) system gives you industrially hardened control with a flexible Linux®-based processor with gateway functions, guaranteed-for-life I/O, and software for your automation and IIoT applications.

### groov EPIC Processor

The heart of the system is the groov EPIC processor. It handles a wide range of digital, analog, and serial functions for data collection, remote monitoring, process control, and discrete and hybrid manufacturing.

In addition, the EPIC provides secure data communications among physical assets, control systems, software applications, and online services, both on premises and in the cloud. No industrial PC needed.

Configuring and troubleshooting I/O and networking is easier with the EPIC's integrated high-resolution color touchscreen. Authorized users can manage the system locally on the touchscreen, on a monitor connected via the HDMI or USB ports, or on a PC or mobile device with a web browser.

### groov EPIC I/O

groov I/O connects locally to sensors and equipment. Modules have a spring-clamp terminal strip, integrated wireway, swing-away cover, and LEDs indicating module health and discrete channel status. groov I/O is hot swappable, UL Hazardous Locations approved, and ATEX compliant.

### groov EPIC Software

The groov EPIC processor comes ready to run the software you need:

- Programming: Choose flowchart-based PAC Control, CODESYS Development System for IEC61131-3 compliant programs, or secure shell access (SSH) to the Linux OS for custom applications
- Node-RED for creating simple IIoT logic flows from pre-built nodes
- Efficient MQTT data communications with string or Sparkplug data formats
- HMI: groov View to build your own HMI viewable on touchscreen, PCs, and mobile devices; PAC Display for a Windows HMI; Node-RED dashboard UI
- Ignition or Ignition Edge® from Inductive Automation (requires license purchase) with OPC-UA drivers to Allen-Bradley®, Siemens®, and other control systems, and MQTT communications



### Older products

From solid state relays, to world-famous G4 and SNAP I/O, to SNAP PAC controllers, older Opto 22 products are still supported and working hard at thousands of installations worldwide. You can count on us for the reliability and service you expect, now and in the future.

## QUALITY

Founded in 1974, Opto 22 has established a worldwide reputation for high-quality products. All are made in the U.S.A. at our manufacturing facility in Temecula, California.

Because we test each product twice before it leaves our factory rather than testing a sample of each batch, we can afford to guarantee most solid-state relays and optically isolated I/O modules for life.

## FREE PRODUCT SUPPORT

Opto 22's California-based Product Support Group offers free technical support for Opto 22 products from engineers with decades of training and experience. Support is available in English and Spanish by phone or email, Monday–Friday, 7 a.m. to 5 p.m. PST.

Support is always available on our website, including [free online training](#) at OptoU, how-to [videos](#), [user's guides](#), the Opto 22 KnowledgeBase, and [OptoForums](#).

## PURCHASING OPTO 22 PRODUCTS

Opto 22 products are sold directly and through a worldwide network of distributors, partners, and system integrators. For more information, contact Opto 22 headquarters at **800-321-6786** (toll-free in the U.S. and Canada) or **+1-951-695-3000**, or visit our website at [www.opto22.com](http://www.opto22.com).